

Operator's



Spray Star 1750

1752 Radion 8140

1754 TeeJet 744

1755 DynaJet/Aeros

1758 DynaJet/Radion 8140

SN 175G353

January 2020

Product Support:

Hwy 55 & Poplar Ave; Cameron WI 54822

1-800-891-9435 productsupport@smithco.com

CONTENTS

Introduction	1-8
Introduction	1
Symbols	2
General Safe Practices	3-6
Specifications	7
Optional Spray Equipment	7
Set Up	8
Operation	9-14
Controls & Instruments.....	9-10
Operating Instructions	11-12
Tank Agitation.....	13
Spray Cleaning.....	14
Diagrams.....	15-16
Wiring	15
Hydraulic	16
Spraying Procedure.....	17-24
Spraying Introduction	17
Turf Management.....	18
Hose & Handgun Spraying.....	18
Nozzles	19-20
Calibration Introduction	21
The Nozzle Chart Method of Calibration	22-23
The “128” Method of Boom Sprayer Calibration ..	23-24
Nozzle Charts	25-26
Reference.....	27-29
Abbreviations and Conversions	27
Declaration of Conformity.....	28-29
Quick Reference	30
Warranty.....	

Thank you for purchasing a **Smithco** product.

Read this manual and all other manuals pertaining to the Spray Star 1750 carefully as they have safety, operating, assembly and maintenance instructions. Failure to do so could result in personal injury or equipment damage. Use in conjunction with appropriate TeeJet Manuals.

Keep manuals in a safe place after operator and maintenance personnel have read them. Right and left sides are from the operator's seat, facing forward.

 **WARNING:**

Engine exhaust and some of its constituents are known to the State of California to cause cancer, birth defects, and other reproductive harm.
For more information visit
www.P65Warning.ca.gov

WARNING

Failure to follow cautious operating practices can result in serious injury to the operator or other persons. The owner must understand these instructions, and must allow only trained persons who understand these instructions to operate this vehicle.

All **Smithco** machines have a Serial Number and Model Number. Both numbers are needed when ordering parts. The serial number plate on the Spray Star 1750 is located on the left main frame, by front bumper. Refer to engine manual for placement of engine serial number.











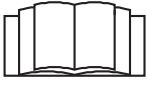

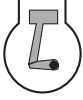

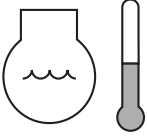
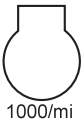
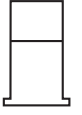





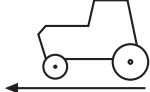

For product and accessory information, help finding a dealer, or to register your product please contact us at www.smithco.com

Information needed when ordering replacement parts:

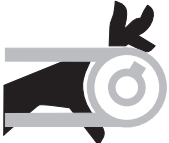
1. Model Number of machine
2. Serial Number of machine
3. Name and Part Number of part
4. Quantity of parts

SMITHCO WAYNE, PENNSYLVANIA 19087 USA 610-688-4009 Fax 610-688-6069			
SERIAL NO. <input type="text"/>	kW/hp <input type="text"/>	DATE OF MFG. <input type="text"/>	
MODEL NO. <input type="text"/>	lb/kg Empty <input type="text"/>	lb/kg Full <input type="text"/>	

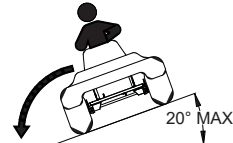
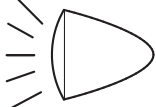
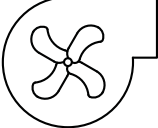
SYMBOLS

				
Read Operator's Manual	Engine Stop	Engine Start	Engine Run	Engine Oil
				
Water Temperature	RPM	Gasoline	Diesel	Glow Plug
				
Hour Meter	Hand Throttle	Choke	Hydraulic Oil Level	Ground Speed
				
Park Brake	Park Brake Release	Fast	Slow	Lift Arm
				
Moving Parts	Pinch Point	Hot Surface	Hydraulic Fluid Penetration	No Riders
				
Rollover Danger	Headlamp	Blower	Warning Danger Caution	Seat Belt

Read and understand this manual and all safety signs before operating and maintaining. Review the safety instructions and precautions annually.

TAKE NOTE! THIS SAFETY ALERT SYMBOL FOUND THROUGHOUT THIS MANUAL IS USED TO CALL YOUR ATTENTION TO INSTRUCTIONS INVOLVING YOUR PERSONAL SAFETY AND THE SAFETY OF OTHERS. FAILURE TO FOLLOW THESE INSTRUCTIONS CAN RESULT IN INJURY OR DEATH.



Safety Alert Symbol!

This symbol with a warning statement means: **Warning, be alert! Your safety is involved!**
Carefully read the message that follows.

SAFETY SIGNAL WORDS

Note the use of the signal words DANGER, WARNING and CAUTION with the safety messages. The appropriate signal word for each has been selected using the following guidelines:



DANGER

DANGER: Red. Indicates an imminently hazardous situation that, if not avoided, will result in death or serious injury. This signal word is to be limited to the most extreme situations typically for machine components which, for functional purposes, cannot be guarded.



WARNING

WARNING: Orange. Indicates a potentially hazardous situation that, if not avoided, could result in death or serious injury, and includes hazards that are exposed when guards are removed. It may also be used to alert against unsafe practices.



CAUTION

CAUTION: Yellow. Indicates a potentially hazardous situation that, if not avoided, may result in minor or moderate injury. It may also be used to alert against unsafe practices.



IMPORTANT

IMPORTANT: Blue. Indicates procedures which should be followed to avoid damage to the machine.

SAFETY DECAL LOCATION

⚠ WARNING

If Safety Decals** have been damaged, removed, become illegible or parts replaced without decals, new decals must be applied. New decals are available from your authorized distributor.

This is a list of decals located on the Spray Star 1750. Part number, description and location will help in reordering decals.

A	15-902	Decal, Tank Volume
C	15-903	Decal, Rear tank Volume
D	15-463	Decal, Spray Pump
E	15-636	Decal, Spray Star 1750
F	15-637	Decal, Control Panel
G	15-672	Decal, Dash
H	15-719	Decal, Speed Control
I	16-228	Decal, Towing
J	25-279	Decal, Hot and Moving Parts
K	25-307	Decal, Gas
L	25-286	Decal, Pinch Point
M	25-298	Decal, Warning Hot
N	25-356	Decal, Tire Pressure
O	25-373	Decal, Smithco
P	25-381	Decal, 96 dBA
Q	27-077	Decal, Smithco
R	27-093	Decal, Hydraulic Oil
S	25-277	Decal, Battery
T	34-147	Decal, Smithco

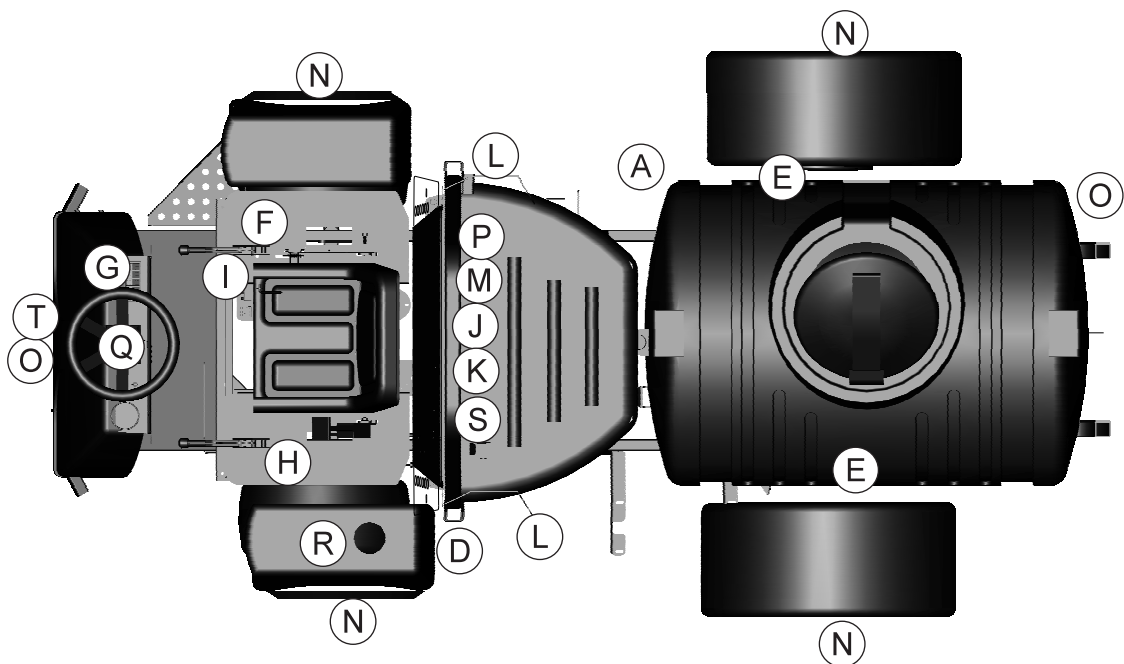



1. It is your responsibility to read this manual and all publications associated with this machine.
2. Never allow anyone to operate or service the machine or its optional equipment without proper training and instructions. Never allow minors to operate any equipment.
3. Learn the proper use of the machine, the location and purpose of all the controls and gauges before you operate the equipment. Working with unfamiliar equipment can lead to accidents.
4. Wear all the necessary protective clothing and personal safety devices to protect your head, eyes, ears, hands and feet. Operate the machine only in daylight or in good artificial light.
5. Inspect the area where the equipment will be used. Pick up all debris you can find before operating. Beware of overhead obstructions and underground obstacles. Stay alert for hidden hazards.
6. Never operate equipment that is not in perfect working order or without decals, guards, shields, or other protective devices in place.
7. Never disconnect or bypass any switch.
8. Carbon monoxide in the exhaust fumes can be fatal when inhaled, never operate a machine without proper ventilation.
9. Fuel is highly flammable, handle with care. When filling tank stop 1 inch(2.54 cm) from top. Leave room for expansion. **DO NOT OVERFILL.**
10. Keep engine clean. Allow the engine to cool before storing and always remove the ignition key.
11. Disengage all drives and set park brake before starting the engine.
12. Never use your hands to search for oil leaks. Hydraulic fluid under pressure can penetrate the skin and cause serious injury.
13. This machine demands your attention. To prevent loss of control or tipping of the vehicle:
 - A. Use extra caution in backing up the vehicle. Ensure area is clear.
 - B. Do not stop or start suddenly on any slope.
 - C. Reduce speed on slopes and in sharp turns. Use caution when changing directions on slopes.
 - D. Stay alert for holes in the terrain and other hidden hazards.
14. Before leaving operator's position:
 - A. Disengage all drives.
 - B. Set park brake.
 - C. Shut engine off and remove the ignition key.
 - D. If engine has to run to perform any maintenance keep hands, feet, clothing and all other parts of body away from moving parts.
15. Keep hands, feet and clothing away from moving parts. Wait for all movement to stop before you clean, adjust or service the machine.
16. Keep the area of operation clear of all bystanders.
17. Never carry passengers.
18. Stop engine before making repairs/adjustments or checking/adding oil to the crankcase.
19. Use parts and materials supplied by **Smithco** only. Do not modify any function or part.
20. Use caution when booms are down as they extend out beyond the center line of the machine.
21. The spray tank is a confined space, take precaution.

These machines are intended for professional maintenance on golf courses, sports turf, and any other area maintained turf and related trails, paths and lots. No guaranty as to the suitability for any task is expressed or implied.

SAFE SPRAYING PRACTICES

Persons engaged in the handling, preparation or application of chemicals must follow accepted practices to insure the safety of themselves and others,

1. **WEAR** protective clothing including: gloves, hat, respirator, eye protection and skin covering suitable for protection from chemicals being used.
2. **BATHE** thoroughly after any exposure to chemicals, giving particular attention to eyes, nose, ears and mouth.
3. **CLEAN** equipment and materials in accordance with employer, municipal and state regulations. Use only approved areas and drains.
4. **DISPOSE** of chemicals and rinse solutions by approved and legal means.
5. **PROVIDE** methods and materials for operators to wash eyes and hands immediately during the spraying process.
6. **PROVIDE** methods and materials for control, safe dilution and neutralization of chemical spills during preparation, spraying, transporting and cleanup.
7. Always check and follow the directions and safety warnings of the chemicals to be used.
8. Secure the discharge lines before starting the pump. An unsecured discharge line may whip.
9. Periodically inspect the pump and the system components.
10. Check hoses for weak or worn condition before each use. Make certain that all connections are tight and secure.
11. Do not operate unit with leaks, frayed, kinked hoses or tubing. Repair or replace immediately.
12. Use only pipe, hose and fittings rated for maximum pressure or pressure at which pressure relief valve is set at. When replacing pipe, hose or fittings, use new product.
13. Do not operate any fuel engines in an enclosed area. Be sure the area is well ventilated.
14. Do not use these pumps for pumping water or other liquids for human or animal consumption.
15.  **WARNING** Do not pump flammable or explosive fluids such as gasoline, fuel oil, kerosene, etc. Do not use in explosive atmospheres. The pump should be used only with liquids compatible with the pump component materials.
16. Be sure all exposed moving parts are guarded and that all coupling devices are securely attached before applying power.
17. Before servicing, disconnect all power, make sure all pressure in the system is relieved, drain all liquids from the system and flush.
18. Protect pump from freezing conditions by draining liquid and pumping rust inhibiting antifreeze solution through the system, coating the pump interior.
19. **TRANSPORT** - Machine **must be stopped** to raise or lower booms. Because of cam system, if booms are raised in transit they can fall forward or backward when coming to a stop or while traveling on uneven terrain.
20.  **IMPORTANT** If using Simulated Speed with a Radion 8140, one needs to change back to Ground Speed for proper rate control when spraying.

SPECIFICATIONS

WEIGHTS AND DIMENSIONS

Length	120" (305 cm)
Width	65" (165 cm)
Width With Boom Open	240" (610 cm)
Height w/ ROPS	77" (195 cm)
Height w/ Booms Folded	110" (279 cm)
Wheel Base	68" (173 cm)
Weight Empty	1750 lbs (794 kg)
Weight Full	3500 lbs (1588 kg)

1750 GAS

SOUND LEVEL (DB)

At ear level	96 dBA
At 3 ft (0.914 m)	98 dBA
At 30 ft (9.14 m)	88 dBA

ENGINE

Make	Briggs & Stratton
Model#	613477
Type / Spec#	0271-J1
Horsepower	35 hp (26 kW)
Fuel	Unleaded 87 Octane Gasoline Minimum
Cooling System	Air Cooled
Lubrication System	Full Pressure
Alternator	20 Amp

WHEELS & TIRE

Front: Two 20 x 10.00 x 10 NHS Multi-Rib; 20 psi (1.4 bar)
Rear: Two 24 x 13.00 x 12 NHS Multi-Trac; 20 psi (1.4 bar)

SPEED

Infinitely Variable 0-12 m.p.h. (0-20 kph)

BATTERY

Automotive type	24F - 12 volt
BCI Group	Size 24
Cold Cranking Amps	900 minimum
Ground Terminal Polarity	Negative (-)
Maximum Length	10.25" (26 cm)
Maximum Width	6.88" (17 cm)
Maximum Height	10" (25 cm)

FLUID CAPACITY

Crankcase Oil	See Engine Manual
Fuel	10 gallon (37,9 liters)
Hydraulic Fluid	5 gallon (19 liters)
Grade of Hydraulic Fluid	SAE 10W-40 API Service SJ or higher Motor Oil

OPTIONAL EQUIPMENT

15-618	Water Meter Kit (Liters)	14-515	Water Meter Kit (Gallons)
15-619	Chemical Clean-load	17-506	Fresh Water Wash Tank
15-622	Canopy	15-835	Tank Rinsing System
17-505	Foam Marker	14-308	Hose Reel Mount Kit for HD Booms
17-580	20' HD Super Boom	17-585	18.5' HD Super Boom
30-141	26 Gal. Wash System with Electric Pump		
16-129	Manual Rewind Hose Reel, 200-foot/61-meter capacity		
16-906	Electric Rewind Hose Reel, 200-foot/61-meter capacity		



SETUP

The Spray Star 1750 arrives from **Smithco** setup and ready for service. Depending on freight conditions the battery may have to be installed.

The spray system is normally shipped attached to the 1750 Prime Mover. If a spray system is to be fitted to a Prime Mover by a dealer or factory, assemble and attach the components in accordance with the parts drawings in the *Spray Star 1750 Parts/Service Manual*.

1. Check the tire pressure. The front and rear tires are 20 psi (1.4 bar).
2. Battery is located under the seat. This is a negative grounding system.

⚠ WARNING

Connecting battery cables to the wrong post could result in personal injury and/or damage to the electrical system. Make sure battery and cables do not interfere or rub on any moving part. Connect red positive (+) cable (A) to battery first. When disconnecting remove black negative (-) cable (B) first.

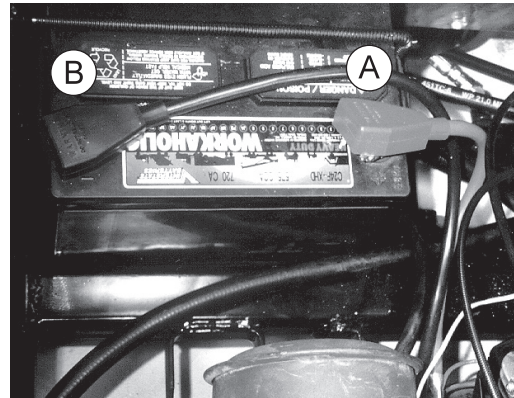

3. Check hydraulic fluid level in tank located under the seat. Remove cap and add SAE 10W-40 API Service SJ or higher motor oil if necessary. Fluid level should be about 2-2 $\frac{1}{2}$ " (5-6.4 cm) from the top of the tank when cold. **DO NOT OVERFILL.**
4. Fill fuel tank, located on the left side, with Unleaded 87 Octane gasoline (minimum). When filling the fuel tank stop when the fuel reaches 1 inch (2.54cm) from the top. This space is necessary for fuel expansion. **DO NOT OVERFILL.**

⚠ DANGER

Fuel is flammable, caution must be used when storing or handling it. Do not fill fuel tank while engine is running or in an enclosed area, fumes are explosive and dangerous to inhale. DO NOT SMOKE while filling the fuel tank. DO NOT OVERFILL.

5. Machine should be greased before starting, refer to *Spray Star 1750 Parts/Service Manual* for location.
6. Attach the Spray Boom and any other Optional Equipment to the Prime Mover, in accordance with instructions in the *Spray Star 1750 Parts/Service Manual*. The nozzles must be the correct distance above the turf as described in *Turf Spraying Guide*. The spray boom must operate properly and the outer sections must break away safely if an object is struck by them, they must then return to normal operation position.
7. Be sure to double check boom heights, nozzle spacing and displacement before spraying.
8. Machine is shipped with windshield washer fluid in Spray System to prevent freezing. Flush system completely with clear water. Fill tank with water and re-tighten the four bolts used to hold the tank in place.

⚠ WARNING

Never allow pump to run dry! The valve on the suction side of the pump (between the pump and tank) must be fully open whenever the pump is operated.

9. Read operating instructions before starting.

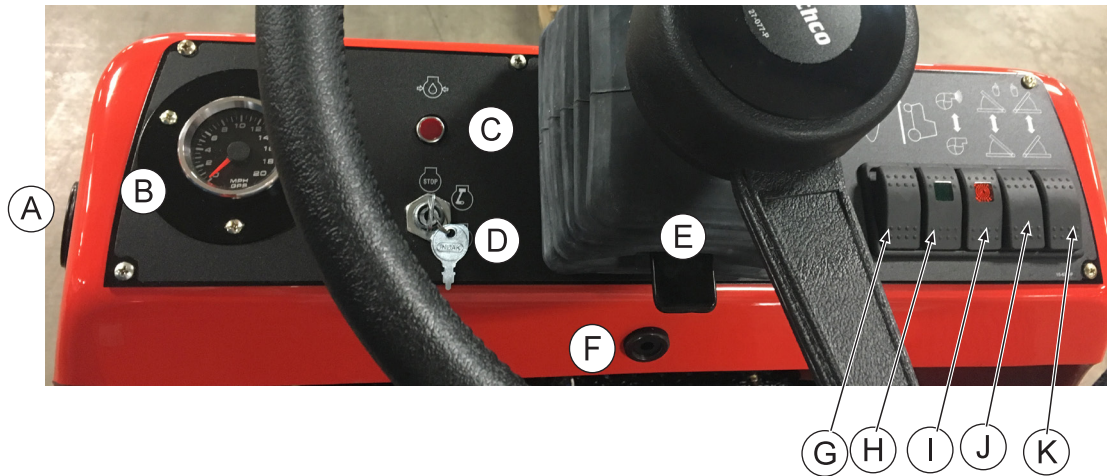

- A. Hour Meter - The hour meter indicates hours of machine operation. It operates only when the ignition switch is on.
- B. GPS Speedometer - The speedometer indicates ground speed of the vehicle in miles per hour and kilometers per hour using GPS technology. The antenna is on top of the ROPs.
- C. Oil Light - The oil light should come on when the ignition is on without the engine running and go out when the engine is running. The oil light will light when the oil pressure is low. If oil light should come on, shut engine off immediately and find the cause.
- D. Ignition Switch - The ignition switch has three positions: Off - Run - Start.
- E. Tilt Steering - Hold lever down and adjust steering wheel to desired position and release lever.
- F. Buzzer - The buzzer sounds if the pump is running dry.
- G. Lights - This rocker switch turns lights on by pushing on the top and off by pushing on the bottom.
- H. Ground Speed (Cruise) Control - This rocker switch initiates cruise control by pushing on the top and turning it off by pushing on the bottom. Works with ground Speed Control Foot switch.
- I. Spray Pump - This toggle switch turns the spray pump on by pushing on the top and off by pushing on the bottom.
- J. Left Boom Switch - This rocker switch lifts and lowers the left boom.
- K. Right Boom Switch - This rocker switch lifts and lowers the right boom.
- L. Hand Throttle - The hand throttle is used to regulate engine speed.
- M. Choke - The choke is used in starting the engine. Pull choke out to close choke plate when starting a cold engine. Push in when engine starts. A warm engine may not require "choking" to start.
- N. Park Brake - The park brake is only a parking brake. Pull back to release, push forward to apply. Some adjustment can be made by turning the knob clockwise to tighten and counter clockwise to loosen.

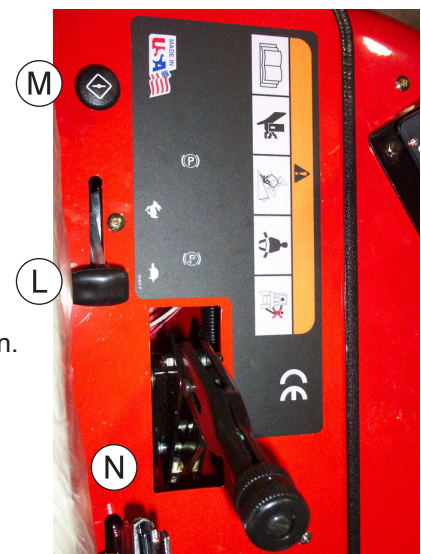

CONTROLS & INSTRUMENTS

- Q. Spray Boss Control - Engages and disengages speed boss. Forward is engage and all the way back is disengage. When the lever is engaged it sets a stop for the accelerator. The accelerator pedal must be used to maintain this speed. To adjust speed use the knob on the end of the lever, counter clockwise increases speed and clockwise decreases speed. Disengage the lever and you will have full accelerator pedal range.
- R. Cup Holder - Holds standard cup.
- S. Ground Speed (Cruise) Control Foot Switch - When rocker switch is turned on and desired speed is obtained, push foot speed control switch to set cruise.
- T. Master Boom Switch - is used to override the master switch on the computer console of the spray systems.
- U. Reverse / Accelerator Pedal - This pedal controls ground speed. Press pedal to increase speed. Varying the amount of movement of the pedal will vary the ground speed. To activate Reverse, you lift up on the pedal with you toe.



When pedals are released the hydrostatic transmission centers and stops the vehicle with a braking action.

MASTER BOOM SWITCH

The master boom switch (T), located on the left floorboard is used to override the master switch on the computer console of the spray systems. By pushing down it will turn on/off the booms. For *TeeJet Systems*, the master switch on the computer **must be on**.

GROUND SPEED CONTROL

The ground speed control does not work the same as an automotive type cruise. The ground speed control is located on the center floorboard and is used to lock forward speed.

TO ENGAGE:

1. Flip rocker switch 'On' (green light).
2. Obtain desired speed with foot pedal.
3. Step on foot switch to lock speed.
4. Push foot switch again to disengage.

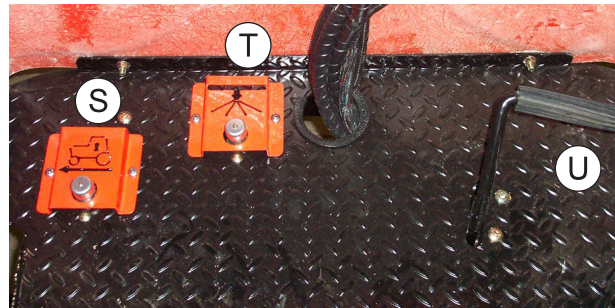

⚠ CAUTION

To avoid abrupt stop, place foot on traction pedal before disengaging speed control.

SPEEDOMETER

This machine is equipped with a GPS Speedometer. **Please note** that if the speedometer has been powered off longer than 4 hours, it could take up to 1 minute to acquire signal due to the satellites moving significantly from your location. This is normal. The current draw is extremely low and will have virtually zero impact on a battery's charge. Hot start wire should be connected directly to battery +12volts and should remain powered 100% of the time. When GPS gauge first receives power the needle will sweep full counter clockwise towards 0 mph. Pointer will stay at 0mph and oscillate slightly at zero to indicate the GPS is acquiring satellites. GPS is not yet functional to indicate speed. Once satellites are acquired (15-45 seconds), the pointer will swing full scale and then back toward 0 mph to indicate it is now ready for operation.

Before operating the Spray Star 1750, become familiar with all controls and functions. Also complete all maintenance requirements and read all safety warnings. Knowing the Spray Star 1750 thoroughly, how it operates, and by doing the prescribed maintenance steps, you can expect trouble free operation for years to come.

SAFETY

Safety needs to always be the concern of an operator of a moving vehicle or any machine with moving parts.

1. Keep all shields and guards in place.
2. Keep the parking brake engaged any time the operator is away from the vehicle or whenever service is performed.
3. Always wear the necessary protective clothing and equipment.
4. Turn engine off when refueling or performing maintenance not specifically requiring engine power.

DAILY CHECKLIST

1. Check the engine oil level. Add as needed. **DO NOT OVERFILL.** Refer to engine owner's manual for oil grade and procedure.
2. Tire pressure should be 20 psi (1.4 bar) maximum.
3. Inspect the electrical system and battery cables for loose connections or frayed wiring. Replace any faulty equipment or tighten if loose.
4. Check hardware for loose or missing nuts, bolts, screws, etc., and tighten or replace as needed.
5. Inspect hydraulic lines for damage or leaks. Never use hands to inspect for leaks.
6. Check the hydraulic fluid level. The hydraulic fluid tank is located on the left side of the machine. The fluid level should be 2"-2½" (5 - 6.4 cm) from the top of the tank when cold. Use only SAE 10W-40 API Service SJ or higher Motor Oil.
7. Inspect the steering, throttle and shift linkages for good hookups and clear travel.
8. Check controls for smooth, proper working operation. Lubricate as needed.
9. Check park brake adjustments. Adjust as required.
10. Check anti-vibration mounts on engine frame.

STARTING THE ENGINE

1. Make sure the fuel flow valve is 'On'. It is located on the fuel tank.
2. The ignition switch is located on the dashboard. Insert the key (A) and turn clockwise until the engine starts (C). Release the key and it will return to the run position (B). Use the choke and hand throttle as necessary.
3. Diesel - Insert the key (A) and turn clockwise to (B). When glow plug light goes off Turn key to (C) until the engine starts. Release the key and it will return to the run position (B).
4. Allow engine to idle and warm up before selecting direction of travel.

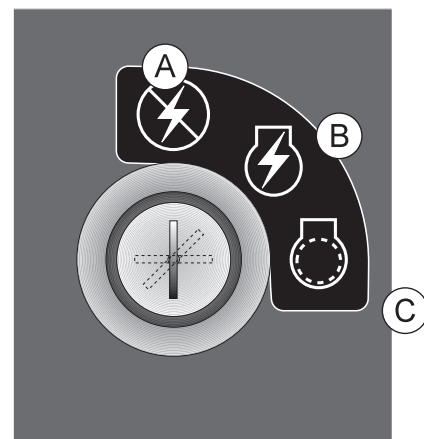

STOPPING THE ENGINE

⚠ IMPORTANT

If the engine has been running under high power, let it run at slow idle speed a few minutes to cool the engine down, before turning the ignition switch to the OFF position.

1. Disengage spray pump.
2. Move the throttle lever to "slow" and turn ignition key to the "off" position.
3. Remove the ignition key and engage the park brake.

⚠ CAUTION

Never leave the vehicle unattended with the engine running. Always bring the vehicle to a complete stop, engage park brake, turn key off and remove key.

OPERATION

Before using the Spray Star 1750, the operator and spray technician must familiarize themselves with all of the information on chemical spraying contained in the *Turf Spray Guide*.

⚠ IMPORTANT

All testing and calibrating of sprayers is to be done with water, not chemicals. This insures the safety to all involved in performing the calibration operation. Only after all calibration procedures are completed should chemical be added to the sprayer.

TOWING UNIT

When it is necessary to move the Spray Star 1750 without the engine running, the bypass valve built into hydrostatic pump must be "open" by turning it $\frac{1}{4}$ turn to open. The valve is located on the back side of the pump. An "open" valve allows fluid to pass through the wheels freely. When normal driven operation is desired, valve should be "closed" by turning it clockwise. Failure to "close" the valve with engine running means no power to wheels.

HILLSIDE OPERATION

Do NOT stop or start suddenly on any slope. Be especially cautious when changing direction. Do NOT operate on slopes greater than 10°.

BATTERY

Batteries normally produce explosive gases which can cause personal injury. Do not allow flames, sparks or any ignited object to come near the battery. When charging or working near battery, always shield your eyes and always provide proper ventilation.

Battery cable should be disconnected before using "Fast Charge".

Charge battery at 15 amps for 10 minutes or 7 amps for 30 minutes. Do not exceed the recommended charging rate. If electrolyte starts boiling over, decrease charging.

Always remove grounded (-) battery clamp first and replace it last. Avoid hazards by:

1. Filling batteries in well-ventilated areas.
2. Wear eye protection and rubber gloves.
3. Avoid breathing fumes when electrolyte is added.
4. Avoid spilling or dripping electrolyte.

⚠ WARNING

Battery Electrolyte is an acidic solution and should be handled with care. If electrolyte is splashed on any part of your body, flush all contact areas immediately with liberal amounts of water. Get medical attention immediately.

JUMP STARTING

⚠ WARNING

Use of booster battery and jumper cables. Particular care should be used when connecting a booster battery. Use proper polarity in order to prevent sparks.

To jump start (negative grounded battery):

1. Shield eyes.
2. Connect ends of one cable to positive (+) terminals of each battery, first (A) then (B).
3. Connect one end of other cable to negative (-) terminal of "good" battery (C).
4. Connect other end of cable (D) to engine block on unit being started (NOT to negative (-) terminal of battery)

To prevent damage to other electrical components on unit being started, make certain that engine is at idle speed before disconnecting jumper cables.

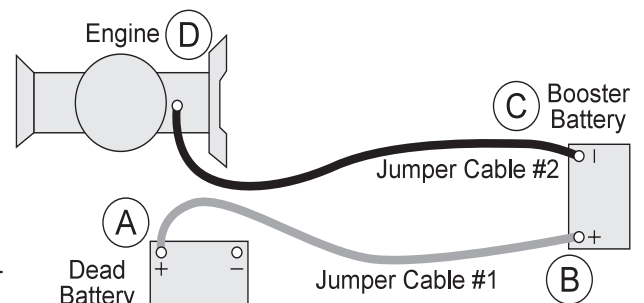

SPRAYER VALVE SETTINGS AND SPRAY TANK AGITATION

The ball valve on the suction side of the pump, between the tank and the pump must be open before pump is engaged. Close this valve only when necessary to clean the filter with spray material in the spray tank.

There is one manual flow control valve on the discharge side of the spray system. This valve controls the agitator. This valve may be opened as much as necessary to provide hydraulic agitation through the quadra-jet agitator in the tank bottom. This valve may be partially closed to prevent or reduce foam buildup from the spray materials inside the tank. When the liquid level in the spray tank reaches a certain level (usually 1-25 gallons (3.8-95 Liters) depending on terrain and other conditions) it may be necessary to close the valve in the agitator line in order to prevent loss of suction prime.

If your Spray Star is fitted with a hose reel, there is a second ball valve on the discharge system to supply material to the hose reel.

The Quadrajet agitation system operates with four venturi jets in the tank bottom. These jets have replaceable orifice discs which discharge the following amounts of spay material.

Nozzle Diameter	Input to Agitator in gpm	Input to Agitator in L/min	Agitator Pressure in psi	Agitator Pressure in bar	Agitator Output in gpm	Agitator Output in L/min
1/8"	1.9	7.2	25	1.7	6.3	23.8
1/8"	2.7	10.2	50	3.4	10.0	37.9
1/8"	3.8	14.4	100	6.9	15.0	56.8
5/32"	2.8	10.6	25	1.7	7.6	28.8
5/32"	4.2	15.9	50	3.4	12.2	46.2
5/32"	5.5	20.8	100	6.9	17.5	66.2
3/16"	3.6	13.6	25	1.7	9.1	34.4
3/16"	5.6	21.2	50	33.4	14.3	54.1
3/16"	7.9	29.9	100	6.9	18.7	70.8

You can change orifice disc sizes to enhance spray system performance. Smaller discs reduce amount of agitation (desirable in some foaming materials) and make more dis-chargeable liquid available for nozzles. Larger (or none) discs increase amount of agitation and make less dis chargeable liquid available for nozzles.

AGITATION LINE STRAINER CLEANING

Agitation line strainer is located below the sprayer filter. This strainer catches impurities that go to the turbo-jet agitation system in the spray tank. It has a quick disconnect pin on it to remove the bowl. **After EVERY use**, remove bowl and clean screen. Replace screen as needed. We recommend a 50 Mesh screen.

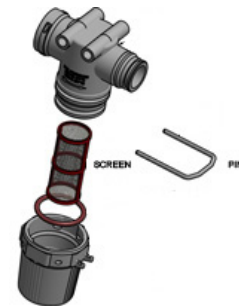

DYNAJET® NOZZLE CLEANING

The Nozzle Coil Assembly will need to be taken apart and cleaned on a regular basis. To take apart and clean you will need to use two wrenches provided with the DynaJet® System. Loosen the Nozzle assembly by placing a wrench on the tube assembly and one on the stainless cap. Hold one in place and turn the other wrench to loosen assembly. Once apart, clean with water and check for deteriorating parts. Replace parts as needed by ordering the Spare Parts Kit 20-673-01P.

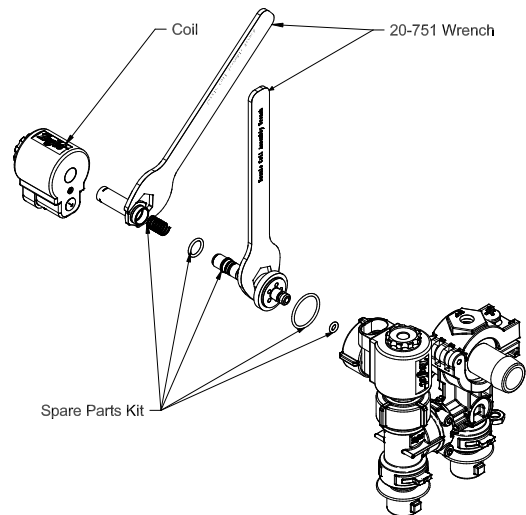

SPRAYER CLEANING

One of the most common causes for faulty-pump performance is corrosion inside the pump. Flush the pump and entire system with a solution that will chemically neutralize the liquid pumped. Mix according to manufacturer's directions. This will dissolve most residue remaining in the pump, leaving the inside of the pump clean for the next use.

TO PREVENT CORROSION

After cleaning the pump as directed, flush it with a permanent type automobile antifreeze (Prestone, Zerex, etc.) containing a rust inhibitor. Use a 50% solution that is, half antifreeze and half water. Then coat the interior of the pump with a substance which will prevent corrosion such as Fluid Film or WD40. If unit will not be used for an extended period of time, disconnect hoses into and out of the pump, seal openings to the pump with caps or tape. Dispose of fluids according to all federal, state and local regulations.



IMPORTANT

All chemicals and chemical residue must be removed after each use. Dispose of fluids and residue according to all federal, state and local regulations.

SPRAYER CLEANING

Empty tank and clean unit thoroughly after each use following these instructions:

1. Turn off 3-way valve and rinse inside of tank thoroughly with clean water, remove cap from valve to drain.
2. Fill tank ten percent full with clean water, Turn 3-way valve on and start pump and discharge water through spray hose or spray boom (with nozzles removed), until empty.
3. Turn off 3-way valve again and rinse tank interior thoroughly. Remove cap from 3-way valve to drain.
4. Rinse exterior of sprayer thoroughly with clean water.
5. This sprayer is equipped with a self cleaning strainer. The strainer uses the excess pump flow to bypass clogging particles back to the spray tank. There is a gap between the tapered inner cylinder and the screen face that causes the inlet fluid to flow at a high velocity past the screen face providing a continuous wash down of particles. For this wash down to occur a minimum of +GPM/23 l/min is required through the bypass line.

AGITATION LINE STRAINER CLEANING

Agitation line strainer is located below the sprayer filter. This strainer catches impurities that go to the turbo-jet agitation system in the spray tank. It has a quick disconnect pin on it to remove the bowl. **After EVERY use**, remove bowl and clean screen. Replace screen as needed. We recommend a 50 Mesh screen.

MANUAL HOSE REEL

Located at the back of the Spray Star on top of the tank. Open the ball valve located near the manifold valve to allow fluid to flow into the hose reel. Place the lockout pin in the unlocked position by pulling and turning it half a turn, this will allow you to pull out additional hose or to use the handle and wind up the hose. To prevent movement during transport or storage place the lockout pin in the locked position.

ELECTRIC HOSE REEL

Located at the back of the Spray Star on top of the tank. Open the ball valve located near the manifold valve to allow fluid to flow into the hose reel. To unwind hose just pull on the hose to get the desired amount. To wind up the hose make sure the toggle switch is in the ON position, push the momentary push button switch until you have reeled in the amount of hose desired. Turn off the safety switch when not in use.

FOAM MARKER

Located to the right of the control panel. Use lever on compressor to designate which boom is to be used to dispense foam. Use dial located on the foamer to adjust pressure for the amount of foam that will be dispensed. Switch on compressor also turns foamer on or off.

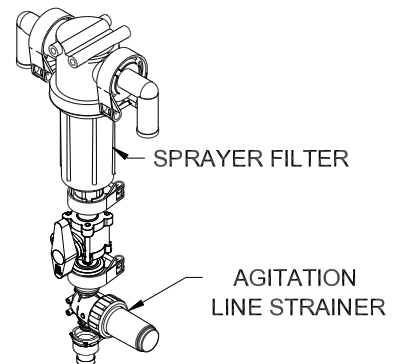

WIRING DIAGRAM

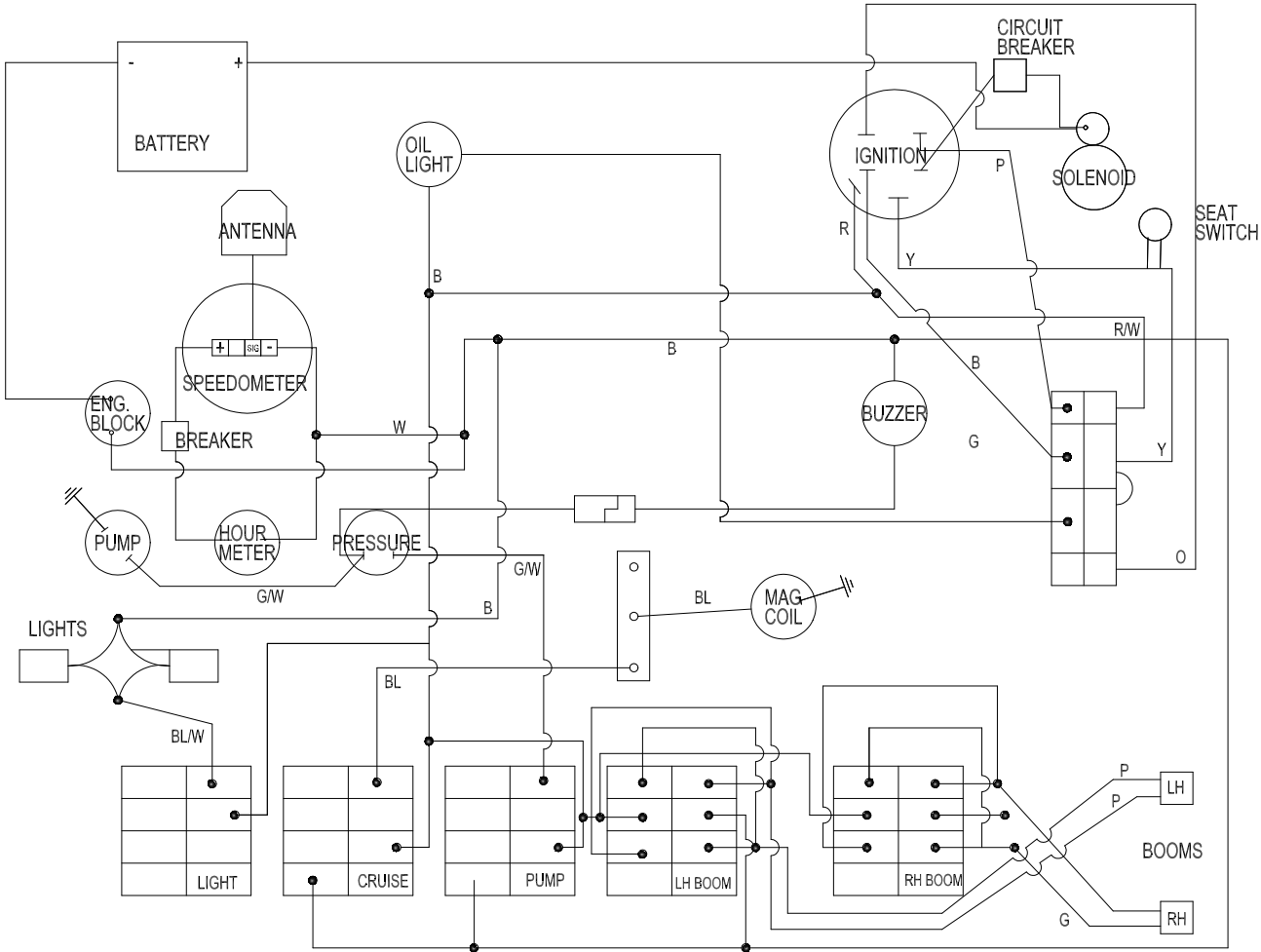

Diagrams

HYDRAULIC DIAGRAM

Diagrams

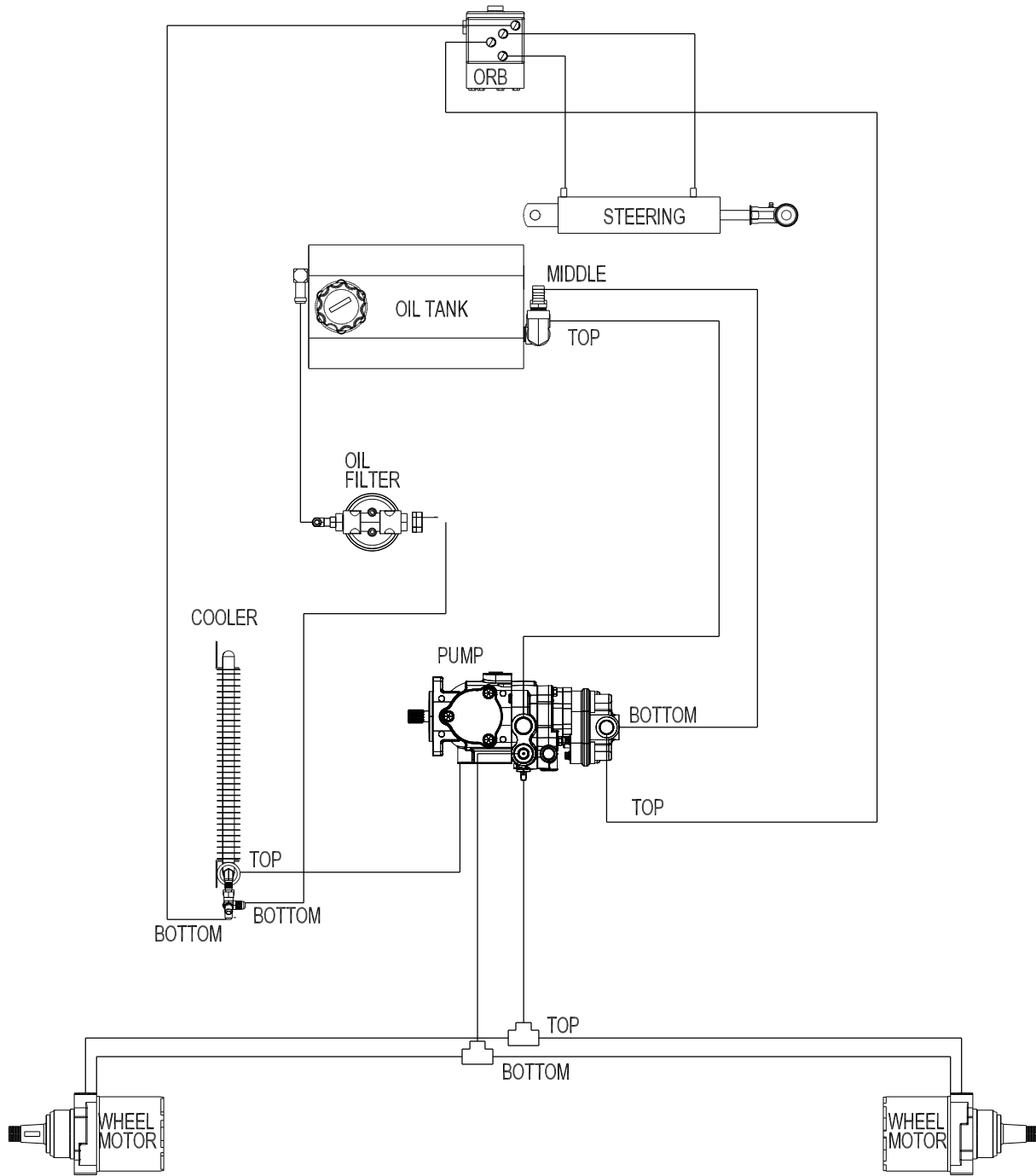

SPRAYING INTRODUCTION

This section is intended to offer practical guidelines for the distribution of liquid chemicals over an area of turf grass such as golf courses, park land, school grounds and lawns. SMITHCO makes no representation as to the suitability of any technique or product for any particular situation. This section is suitable for self-propelled spray vehicles or sprayers mounted onto vehicles.

Boom Spraying is the most effective, accurate and efficient method of applying chemicals to large turf areas. It may be done by means of:

- A dedicated spray vehicle
- A sprayer mounted upon a utility vehicle

Sprayers are typically equipped with wide spray booms. Generally these booms are between 15 feet (4.5 m) and 20 feet (6 m) in width. They are divided into three sections, with hinges that permit the long outer sections to automatically move out of the way and reset if an obstacle such as a tree or fence is in your path.

To minimize the chance for missed areas or double application use a device to mark the outside boundaries of each spray swath. Foam markers and dye markers are advisable.

Use TeeJet User Guide for appropriate spray System.

SPRAY OPERATION (AFTER PROPER SETUP AND CALIBRATION)

1. Add $\frac{1}{2}$ the amount of water required for the spray operation to tank using air gap filler.
 2. Start engine, set engine speed below 2000 RPM, and engage pump after taking all previously described safety and operation precautions.
 3. Open agitator valve.
 4. Add chemicals (taking all precautions described in this manual and by the chemical manufacturer).
 - a. Liquids may be poured directly into tank.
 - b. Wettable powder chemicals must be pre-mixed with water in a container to form a slurry. The mixture is then added to the tank through the fill-well strainer.
 - c. Chemical in soluble packs are place into the fill-well strainer basket and dissolved by adding water through the basket.
 - d. Use Chemical Clean-load Safe-fill System on rear of machine if installed.
- The balance of the water required for the spray operation is added to the tank through the fill-well strainer, using the air gap filler. This will wash any undissolved chemical into the tank.
5. Transport to sprayer site with and agitator operating.
 6. Set Engine speed between 2000-3200 RPM.
 7. (Optional) Engage ground speed control.
 8. Obtain desired spraying speed before activating spray with switches on spray control console.
 9. The master boom switch, located on the left floorboard is used to override the master switch on the computer console of the spray systems. By pushing down it will turn on/off the booms. *For the Radion System* the Master Switch on the computer **must be off** for the master boom control switch to work.

Review the capacity of nozzles being used. Total capacity of all nozzles plus agitation system must not exceed pumping system capabilities refer to *Spraying Procedure* section of this manual. FLUSH PUMP AFTER USE

Shut-Off	20GPM	40GPM	60GPM	80GPM	100GPM
120psi	100psi	80psi	60psi	30psi	10psi
100psi	95psi	76psi	52psi	26psi	5psi
80psi	75psi	62psi	45psi	21psi	-
60psi	55psi	40psi	25psi	5psi	-

To determine the correct performance data for your application, first shut off all flow on discharge side of pump and determine the shut-off pressure at the pump. Use this Shut-Off pressure to determine which line of data applies.

TURF MANAGEMENT

Turf management chemicals are made for four general purposes:

1. **Fungicides:** Prevent or cure fungus on turf grass. They are made in 2 general types:
 - Systemic - Chemicals enter the plant system and protect or cure it of, fungus.
 - Contact - Kills fungus with which it comes into contact.
2. **Insecticides:** Eliminate damaging insects and worms (such as grubs, beetles, ants, etc.)
3. **Herbicides:** Control and eliminate undesirable weeds and grass from turf areas and non-turf areas such as bunkers, trails, fences, etc.
4. **Nutrients & Fertilizer:** Promote growth, beauty and color in turf grass.

Some materials have to be applied so that they get into the soil below the plant leaves, This is called "*soil application*". In order to do this, they are best applied with a *large volume of water*. They are often then *watered-in* using the irrigation system. This type of chemical material includes systemic chemicals and chemicals designed to destroy pests which live in the thatch and the soil.

Other materials must be applied to reach a problem that is present on the plant leaves. This is called "*Foliar Application*" and requires a *lower volume of water*. Instead of irrigation water, these materials are further activated by dry air and sunshine. They include contact fungicide and many herbicides.

The user of sprayers and chemicals must follow the directions provided with the spray material. It is the only way to insure safe and effective results. It provides information on how much chemical and how much water is to be applied to the area to be sprayed.

Though there are many types and sizes of nozzles, two specific types have proven most successful in turf grass management.

- The first type is **target-directed**. It sprays material in a direct line downwards to the target turf grass. These are flat fan nozzles, commonly referred to as TeeJet nozzles. They are available in a wide variety of sizes for any required discharge volume rate. They are the best for many contact or foliar applied pesticides. They are spaced either 10" (25 cm) or 20" (51 cm) apart and overlap one another by about $\frac{1}{3}$.
- The second type useful in turf management are **broadcast** type nozzles. They are commonly referred to as raindrop or floodjet nozzles. They spray a hollow-cone shaped pattern of much larger droplets which fall quickly to the turf under their own weight. They are best for systemic pesticides or any material requiring a large volume of water for soil application. The larger droplets are not as subject to drift from wind and are a safer, more environmentally friendly choice in many situations.

HOSE & HANDGUN SPRAYING

A handgun (hand-nozzle or hand-lance) is used to control and direct the spray pattern to the ground, shrub or tree. They must be constructed of long lasting and noncorrosive materials such as brass, stainless or aluminum. The handgun fits to a hose of any length from the sprayer allowing operator mobility. The hose should be as short as possible while still permitting operator mobility.

Liquid loses pressure due to friction as it travels through the hose, 1-3 psi (0.07-0.21 bar) for each foot (30 cm) of hose. For most operations $\frac{1}{2}$ " (1.25 cm) inside diameter hose is adequate. Trees over 40 ft (12 m) high require $\frac{3}{4}$ " (2 cm) inside diameter hose and a sprayer pump capable of delivering a volume of at least 20 gpm (75 lpm) and a pressure of at least 400 psi (28 bar).

Always be alert to the possibility of a plugged or damaged nozzles. Serious misapplications may result. Check nozzle output periodically.

Modern nozzles use spring and diaphragm check valves to insure positive cutoff of chemicals without drip.

Snap-on caps make replacing and cleaning nozzles, quick, easy and fool proof with proper re installation.

An operator can see at a glance if all nozzles are the same size by the color code.

3 FUNCTIONS FOR A SPRAY BOOM NOZZLE

1. Regulating the flow is done through size of the orifice (opening) within the nozzle. All nozzles, regardless of type, have some point within them that regulates the flow of liquid. Obviously, the larger the opening the greater the rate of flow volume. Volume is expressed in Gallons Per Minute (gpm) or Liters Per Minute (lpm). Do not confuse the term volume with application rate, which will be covered later.

As pressure increases, the flow volume in a given nozzle also increases. For example, an average size nozzle which discharges 0.52 gpm (1.4 lpm) at 30 psi (2 bar), will discharge 0.73 gpm (2 lpm) at 60 psi (4 bar). In this example, an increase in pressure of 100% has caused an increase in discharge of 40%.

Some nozzles deliver a small volume (for example: 0.2 gpm (0.75 lpm)). Some nozzles deliver a relatively large volume (for example: 1.5 gpm (5.7 lpm)), or $7\frac{1}{2}$ times as much as the smaller nozzle in this example.

The amount of material (volume) to be applied is determined by the effect the chemical has on the turf.

2. The nozzle on a sprayer is to form the liquid into droplets. The size of the droplet is determined by two factors design and system pressure (psi/bar).

Particular applications are done best by big droplets such as systemic fungicides, insecticides and some herbicides in order to reduce drift. Other applications require small droplets like contact fungicides and some herbicides. Again, this is determined by whether the chemical is foliar applied or soil applied. Large droplets for soil applied material, small droplets for foliar applied materials that evenly cover the plant better.

Pressure also affects droplet size. More pressure at the same nozzle produces smaller droplets, more subject to drift. The general rule on pressure is to use the lowest pressure possible with just enough to form adequate spray nozzle patterns.

3. Disperse the material in a specific pattern that will insure even distribution of chemical across the swath covered by the boom.

The pattern of liquid dispersed by the hollow-cone is more even across its width. Each nozzle overlaps the adjoining nozzle by 100%. That is to say the area covered by each nozzle extends to the center of the two nozzles on either side.

As shown (to the right) the pattern formed by flat fan (Tee-Jet) nozzles would show most liquid concentrated at the center, then tapering off where it begins to overlap with the next nozzle—approximately $\frac{1}{3}$.

In order to properly develop their spray pattern, each nozzle must be the proper distance from the next nozzle (spacing) and the proper height above the ground.

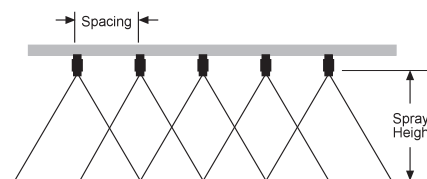

Optimum Spray Height

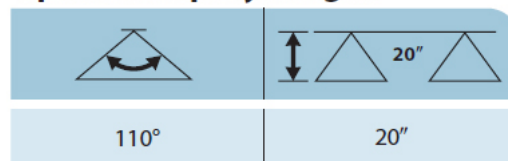

NOZZLES

NOZZLE SCREENS (STRAINERS)

Smaller nozzles require nozzle screens or strainers to prevent clogging.

- Teejet type nozzles size 8001 and 80015 require 100 mesh screens.
- Teejet type nozzles from size 8002 through 8008 require 50 mesh screens.
- Turbo TurfJet Nozzles Size 1/4 TTJ02-VS and larger do not require strainers.
- Turbo Floodjet Nozzles TF-VS2 through TF-VS3 require 50 mesh screens.
- Turbo Floodjet Nozzles TF-VS4 and larger do not require screens.

SPACING



Turf spray nozzles are normally 20" (51 cm) apart. Some cases 40" (101 cm), depending on the type of spray boom and type of area to be sprayed.

Very fine, level areas (golf greens and tees, bowling lawns, tennis courts, etc.) may be sprayed with nozzles spaced every 10" (25 cm).

BOOM HEIGHT

Height is very important in permitting spray nozzles to develop their proper spray pattern. If nozzles are too high, excessive overlap develops. If nozzles are too low, there is not enough overlapping of nozzle spray patterns.

Optimum Spray Height

	
15"	9"
20"	12"
30"	18"

NOZZLE TYPE	NOZZLE SPACING	HEIGHT ABOVE THE GROUND
80° Flat Fan	20" (51 cm)	18" (45 cm)
65° Flat Fan	20" (51 cm)	12" (30 cm)
Turbo TurfJet	20" (51 cm)	15" (38 cm)
Turbo TurfJet	40" (101 cm)	19" (48 cm)
Turbo Floodjet	20" (51 cm)	16" (41 cm)
Turbo Floodjet	40" (100 cm)	18" (45 cm)

Improper nozzle height or spacing prevents proper application of chemical. Some areas are under treated and chemicals are ineffective. Some areas are over treated with wasted chemical and possible turf damage.

Operating your sprayer at a desired speed and pressure on a hard, dry surface is a good method of checking spraying consistency. Observe nozzles in operation, observe if the area dries evenly. If there are alternating wet and dry streaks, raise or lower the spray boom. If the wet streaks are directly under the nozzle, the boom is too low. If the wet streaks are between the nozzles, the boom is too high.

NOZZLE NOMENCLATURE

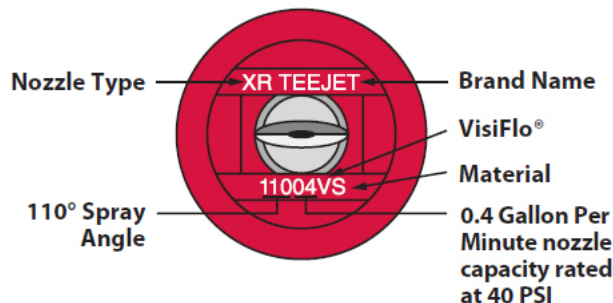

Calibrating simply means to adjust a set of variables on the sprayer in order to deliver the desired amount of chemical to a known area of turf.

The job of calibrating the sprayer consists of balancing these variables so that your sprayer delivers the desired application rate. That is, an amount of chemical on a given area. It is expressed as:

Gallons Per Acre (GPA) (1 US GPA = 0.83 UK GPA)

or **Gallons Per 1,000 Square Feet (gpt)**

or **Liters Per Hectare (lph)** (1 US GPA = 9.35 lph)

A number of acceptable methods for calibrating a turf sprayer are widely available. The calibration method chosen must take these variables into account. They must include known ground speed (by measurement or from an accurate speedometer) and nozzle output (gpm or lpm) from a nozzle chart or from actual measurement. The variables are:

PRESSURE

Just as pressure increases the volume discharge rate, it also increases the application rate. Pressure must increase by 4 times in order to double the application rate. Small pressure changes of 10 psi (1.4 bar) or less do not greatly affect performance.

Pressure is established and maintained by a pressure control valve or by a flow control valve located on the sprayer.

NOZZLE CAPACITY (VOLUME)

We have covered the different types of spray patterns of various nozzles and made our selection of type accordingly. We now have to choose a size which will provide the correct application rate.

Sizes are available for all requirements. Consult the nozzle chart in this manual for your nozzle type in order to select the correct size.

TRAVEL SPEED

Increased travel speed decreases the application rate (GPA, gpt or lph). Travel speed must be safe and appropriate for the area to be sprayed.

Unlike pressure changes which have only a minor effect on application rate, ground speed changes have a more major and direct effect. For example: 50% decrease in ground speed means a 100% increase in application rate. If the vehicle does not have an accurate speedometer, correct speed must be determined by timing the sprayer travel over a measured distance. (Refer to the page in this manual titled, "Abbreviations and Conversions".

To calibrate a sprayer, the user must:

1. **Understand** the Variables
2. **Set** those variables using one of the proven methods available.
3. **Make** a trial run and measure the output (use water, not chemical).
4. **Determine** the output.
5. **Make** adjustments to the 3 variables until the output is at the desired level.

This covers the principles of what must be known to prepare a sprayer for operation.

IMPORTANT

There are other acceptable and proven methods of calibrating a turf sprayer for application. Other techniques may be more suitable depending on operational needs and technical competence of the operator.

THE NOZZLE CHART METHOD OF CALIBRATION

The Nozzle Chart Method is useful when the sprayer nozzles are new or nearly new. It is also the most useful method to employ when the sprayer is equipped with an Electronic Spray Control System. The Electronic Spray Control System does most of the calibration work, it is up to the operator to select the proper combination of nozzle size and ground speed which will deliver the desired application rate.

The nozzle chart method requires the use of the appropriate nozzle charts which are found in the back of this manual. Nozzle charts for other nozzles are available from the manufacturer.

CALIBRATION STEPS

1. **Determine “HOW”** your sprayer is to be calibrated from the list of variables below.

- a. **Nozzle Type** (Teejet, Turbo Turf, Turbo Flood)
- b. **Spacing** (10" (25 cm) or 20" (51 cm) or 30" (76 cm))
- c. **Expression of Application Rate** (GPA or gpt or lph)

The answers to these three questions will direct you to the appropriate nozzle chart for your application. The correct nozzle chart **MUST** be used.

2. **Determine the Desired Application Rate.**

This is determined from the information on chemical labels or other technical information available from a variety of sources.

3. **Determine an Acceptable Ground Speed.**

Conditions over which the sprayer will operate generally dictate the appropriate ground speed. Within the limits of practicality and efficiency, spraying should generally be done at lowest possible speed. This increases operator safety and contributes to more precise application of chemicals. For example, golf greens and tees and hill areas would generally be sprayed in the range of 2½ to 3½ mph (4-6 kph). Larger, open and more level areas such as golf fairways and park or school grounds would be sprayed at 4½ to 6 mph (7-10 kph).

The vehicle which carries or tows the sprayer should be equipped with a precise low-speed speedometer. If it is not, exact ground speed at a given engine speed must be determined by timing the travel of the sprayer over a measured distance.

4. **Determine Nozzle Size.**

You will note from the chart, that application rates from any given nozzle decrease as the ground speed increases. In other words, the faster you drive, the less material you are applying.

Application rates are shown in the columns to the right of the charts. Once the desired application rate is decided upon, it should be located, as nearly as possible in one of these columns on the appropriate chart for your operation. It could well be that the approximate rate desired would be obtained from the nozzles already installed in the boom. If this is not possible, then nozzles will need to be changed.

IMPORTANT

When selecting a new nozzle size the Discharge Rate (gpm or lpm) multiplied by the number of nozzles should not exceed 75% of the actual discharge volume of the sprayer pump. [i.e., if you need to use nozzles which discharge 0.8 gpm (3.0 lpm), and the spray boom is equipped with 12 nozzles, the sprayer pump would have to produce an actual discharge volume of 13 gpm (49 lpm) in order to properly supply these nozzles.] If the collective volume of the spray boom nozzles exceeds the actual discharge volume of the pump, inadequate pressure and poor nozzle distribution patterns may result.

Once nozzle type and size have been determined, those nozzles are installed in the sprayer boom. Nozzles should be expected to be replaced after 15-20 hours of actual sprayer operation. After nozzles are installed, make trial application of water over a known area to check application rate.

THE NOZZLE CHART METHOD OF CALIBRATION (CONTINUED)

5. For Sprayer with Electronic Spray Control Systems.

On sprayers equipped with Electronic Spray Control Systems such as those manufactured by TeeJet, Raven Ind., and Micro-Trak Co., it is still important to select the right type and size of nozzle for the required operation. Electronic Spray Control Systems cannot function properly if the nozzles are not capable of delivering the programmed (desired) application rate. Nozzles which are too large will not develop adequate pressure or satisfactory spray patterns. Nozzles which are too small will not allow the discharge of spray material at the programmed application rate.

Further, when calibrating sprayers which are equipped with Electronic Spray Control Systems, care must be taken to use the mode of operation on the Spray Control System (Gallons per acre "US" Mode); Gallons per 1,000 Square Feet ("Turf" Mode); or Liters per Hectare (Standard International Model), which corresponds with the nozzle calibration charts (GPA, gpt or lph).

6. Using the Nozzle Charts.

Select the correct chart based on your nozzle type, nozzle spacing and desired expression of application rate (GPA, gpt or lph). If the desired operating speed is not found on the nozzle chart, it is simple to determine application rate at different speeds by estimating from the known facts.

Example 1: If the desired speed is $2\frac{1}{2}$ MPH (4 kph) on a sprayer using TurfJet nozzles (Chart 5). The average between the application rates for 2 MPH and 3 MPH may be assumed to be the application rate for $2\frac{1}{2}$ MPH.

Example 2: The desired speed is 6 MPH. Use the application rate column for 3 MPH and divide by 2.

7. Converting Nozzle Chart Method to British Gallons.

To convert any of the Gallon Per Acre rates to Imperial Gallons per acre, (Imp GPA) multiply by 0.83. To convert any of the Liter Per Hectare rates to Imperial Gallons Per Hectare (Imp GPH), multiply by 0.22.

8. Checking the Actual Application Rate.

After the combination of ground speed, nozzle size and operating pressure has been selected, the sprayer should be operated with water only to determine if the target application rate is achieved.

THE "128" METHOD OF BOOM SPRAYER CALIBRATION

The "128" Method is useful for calibrating sprayers and also for checking the calibration of sprayer calibrated by the Nozzle Chart Method and sprayers using Electronic Spray Control Systems. The "128" is based on a convenient mathematical relationship that exists between US Gallons, liquid ounces and acres.

An ounce is 1/128th of a (US) gallon. If an area which was "1/128th of an acre" could be found, the number of ounces applied to that small area would be equal to the number of gallons applied to the acre. Thus, no mathematical computations would be required.

To determine an area which is 1/128 of an acre:

- On nozzles with 20 inch (51 cm) spacing, measure off a distance of 204 ft (62 meters). Mark a "START" and a "STOP" line. The rectangle formed by this distance and the spraying width of one nozzle 20" (51 cm) is equal to 340 square feet which is equal to 1/128 acre. Therefore, the amount of material applied to this area by one nozzle in OUNCES is the same amount of material applied to an acre in GALLONS (GPA).
- On nozzles with 10 inch (25 cm) spacing, the measure distance is 408 feet (124 meters).
- On nozzles with 30 inch (76 cm) spacing the measured distance is 136 feet (41 meters).

THE "128" METHOD OF BOOM SPRAYER CALIBRATION

CALIBRATING FOR APPLICATION

1. Fill the sprayer tank with water. Run the sprayer, inspect it for leaks and make sure all systems function properly.
2. Drive the sprayer through the measured distance discussed above at normal spraying speed, record the travel time required to cover the measured distance in seconds with a stopwatch. The carrying or towing vehicle is to be traveling at the desired speed when it crosses the start line of the measured course. **Repeat this procedure and determine the average of the two times.**
3. With the sprayer parked, run the sprayer at the required pressure level. Catch the output of each nozzle in a container which is marked or graduated in Ounces for the exact same period of time which it took the sprayer to cover the measured course in step #2. It is necessary to operate the vehicle engine at spraying speed using a hand throttle.
4. Observe the volume of water in the collection bottle. The number of OUNCES collected in the time it takes to cover the marked course. Take the average nozzle output by adding the outputs of each nozzle and then dividing that sum by the number of nozzles.

The NUMBER OF OUNCES collected in the time required to cover the SMALL AREA is equal to the NUMBER OF GALLONS applied per ACRE. For example: if an average of 40 ounces of water is collected in the time required to cover the 1/128 acre area, the application rate is 40 gallons per acre (GPA).

IMPORTANT

As a practical matter, if high application rates are desired (above 75 GPA), the measured course length should be reduced by half (i.e. 102 ft (31 m) for 20 inch (52 cm) spaced nozzles). The volume collected (above) is then doubled (multiplied by 2).

AVERAGE OUTPUT (Ounces) = APPLICATION RATE (GPA)

5. Observe individual nozzle output volumes. If an individual nozzle is 10% above or below the average output, check for blockages in the nozzle or in the nozzle strainer. If the nozzle is worn or damaged, replace it.
6. Compare this actual application rate with the recommended rate. If the actual rate is more than 5% higher or lower than the intended rate, adjustments must be made.
7. Minor adjustments in application rate may be made by increasing or decreasing the spraying pressure. Lowering spraying pressure decreases application rate. Increasing spraying pressure increases application rate. This procedure normally does not apply to spray systems controlled by an Electronic Spray Control System, which governs flow rate.
8. Adjustments in application rate may be made by increasing or decreasing the travel speed of the sprayer if conditions permit. Slower speeds increase application rate. Faster speeds decrease application rate.
9. Nozzle sizes can be changed to provide the correct application rate. Refer to the nozzle charts in this book for the desired nozzle type.
10. Re-calibrate the sprayer (steps 2-6) after any adjustments are made.

As previously discussed, there are other acceptable methods of Turf Sprayer Calibration. Chemical suppliers, Agricultural Extension Agents, Universities and consultants of various types offer helpful advice on this subject. Technical catalogs are available from nozzle manufacturers.

TRANSFERRING THE "128" METHOD INTO METRIC (LITERS PER HECTARE)

The same steps are used that are used when calibrating in gallons per acre. First a relationship between a measurable amount (milliliters) and the calibration amount (liter) is determined. That ratio is 1:1000.

Now an area which is 1/1000th of a hectare must be measured.

On spray booms with 51 cm (20 inch) spacing, mark off an area which is 20 meters (65.6 feet) long. The area formed by that length and the width of one spray nozzle (20 meters by 0.5 meters) is 10 square meters which is 1/1000 of a hectare. Therefore, the amount of spray material applied to this small area in milliliters is equal to the amount applied to one hectare in liters.

Then, follow the remaining steps 2-10, substituting milliliters for ounces, liters for gallons, square meters for square feet and hectares for acres.

AVERAGE OUTPUT (Milliliters) = APPLICATION RATE (LITERS/HECTARE)

NOZZLE PERFORMANCE CHART 20" SPACING

Universal Application Rate Chart for 20" Tip

Spacing CAPACITY	LIQUID PRESSURE IN PSI	CAPACITY 1 NOZZLE IN GPM	CAPACITY 1 NOZZLE IN OZ./MIN.	GALLONS PER ACRE - 20" NOZZLE SPACING													
				4 MPH	5 MPH	6 MPH	7 MPH	8 MPH	10 MPH	12 MPH	14 MPH	16 MPH	18 MPH	20 MPH	22 MPH		
01	15	0.061	7.8	4.5	3.6	3.0	2.6	2.3	1.8	1.5	1.3	1.1	1.0	0.91	0.82		
	20	0.071	9.1	5.3	4.2	3.5	3.0	2.6	2.1	1.8	1.5	1.3	1.2	1.1	0.96		
	30	0.087	11	6.5	5.2	4.3	3.7	3.2	2.6	2.2	1.8	1.6	1.4	1.3	1.2		
	40	0.10	13	7.4	5.9	5.0	4.2	3.7	3.0	2.5	2.1	1.9	1.7	1.5	1.4		
	50	0.11	14	8.2	6.5	5.4	4.7	4.1	3.3	2.7	2.3	2.0	1.8	1.6	1.5		
	60	0.12	15	8.9	7.1	5.9	5.1	4.5	3.6	3.0	2.5	2.2	2.0	1.8	1.6		
	75	0.14	18	10.4	8.3	6.9	5.9	5.2	4.2	3.5	3.0	2.6	2.3	2.1	1.9		
90	0.15	19	11.1	8.9	7.4	6.4	5.6	4.5	3.7	3.2	2.8	2.5	2.2	2.0			
015	15	0.092	12	6.8	5.5	4.6	3.9	3.4	2.7	2.3	2.0	1.7	1.5	1.4	1.2		
	20	0.11	14	8.2	6.5	5.4	4.7	4.1	3.3	2.7	2.3	2.0	1.8	1.6	1.5		
	30	0.13	17	9.7	7.7	6.4	5.5	4.8	3.9	3.2	2.8	2.4	2.1	1.9	1.8		
	40	0.15	19	11.1	8.9	7.4	6.4	5.6	4.5	3.7	3.2	2.8	2.5	2.2	2.0		
	50	0.17	22	12.6	10.1	8.4	7.2	6.3	5.0	4.2	3.6	3.2	2.8	2.5	2.3		
	60	0.18	23	13.4	10.7	8.9	7.6	6.7	5.3	4.5	3.8	3.3	3.0	2.7	2.4		
	75	0.21	27	15.6	12.5	10.4	8.9	7.8	6.2	5.2	4.5	3.9	3.5	3.1	2.8		
90	0.23	29	17.1	13.7	11.4	9.8	8.5	6.8	5.7	4.9	4.3	3.8	3.4	3.1			
02	15	0.12	15	8.9	7.1	5.9	5.1	4.5	3.6	3.0	2.5	2.2	2.0	1.8	1.6		
	20	0.14	18	10.4	8.3	6.9	5.9	5.2	4.2	3.5	3.0	2.6	2.3	2.1	1.9		
	30	0.17	22	12.6	10.1	8.4	7.2	6.3	5.0	4.2	3.6	3.2	2.8	2.5	2.3		
	40	0.20	26	14.9	11.9	9.9	8.5	7.4	5.9	5.0	4.2	3.7	3.3	3.0	2.7		
	50	0.22	28	16.3	13.1	10.9	9.3	8.2	6.5	5.4	4.7	4.1	3.6	3.3	3.0		
	60	0.24	31	17.8	14.3	11.9	10.2	8.9	7.1	5.9	5.1	4.5	4.0	3.6	3.2		
	75	0.27	35	20	16.0	13.4	11.5	10.0	8.0	6.7	5.7	5.0	4.5	4.0	3.6		
90	0.30	38	22	17.8	14.9	12.7	11.1	8.9	7.4	6.4	5.6	5.0	4.5	4.1			
025	15	0.15	19	11.1	8.9	7.4	6.4	5.6	4.5	3.7	3.2	2.8	2.5	2.2	2.0		
	20	0.18	23	13.4	10.7	8.9	7.6	6.7	5.3	4.5	3.8	3.3	3.0	2.7	2.4		
	30	0.22	28	16.3	13.1	10.9	9.3	8.2	6.5	5.4	4.7	4.1	3.6	3.3	3.0		
	40	0.25	32	18.6	14.9	12.4	10.6	9.3	7.4	6.2	5.3	4.6	4.1	3.7	3.4		
	50	0.28	36	21	16.6	13.9	11.9	10.4	8.3	6.9	5.9	5.2	4.6	4.2	3.8		
	60	0.31	40	23	18.4	15.3	13.2	11.5	9.2	7.7	6.6	5.8	5.1	4.6	4.2		
	75	0.34	44	25	20	16.8	14.4	12.6	10.1	8.4	7.2	6.3	5.6	5.0	4.6		
90	0.38	49	28	23	18.8	16.1	14.1	11.3	9.4	8.1	7.1	6.3	5.6	5.1			
03	15	0.18	23	13.4	10.7	8.9	7.6	6.7	5.3	4.5	3.8	3.3	3.0	2.7	2.4		
	20	0.21	27	15.6	12.5	10.4	8.9	7.8	6.2	5.2	4.5	3.9	3.5	3.1	2.8		
	30	0.26	33	19.3	15.4	12.9	11.0	9.7	7.7	6.4	5.5	4.8	4.3	3.9	3.5		
	40	0.30	38	22	17.8	14.9	12.7	11.1	8.9	7.4	6.4	5.6	5.0	4.5	4.1		
	50	0.34	44	25	20	16.8	14.4	12.6	10.1	8.4	7.2	6.3	5.6	5.0	4.6		
	60	0.37	47	27	22	18.3	15.7	13.7	11.0	9.2	7.8	6.9	6.1	5.5	5.0		
	75	0.41	52	30	24	20	17.4	15.2	12.2	10.1	8.7	7.6	6.8	6.1	5.5		
90	0.45	58	33	27	22	19.1	16.7	13.4	11.1	9.5	8.4	7.4	6.7	6.1			
04	15	0.24	31	17.8	14.3	11.9	10.2	8.9	7.1	5.9	5.1	4.5	4.0	3.6	3.2		
	20	0.28	36	21	16.6	13.9	11.9	10.4	8.3	6.9	5.9	5.2	4.6	4.2	3.8		
	30	0.35	45	26	21	17.3	14.9	13.0	10.4	8.7	7.4	6.5	5.8	5.2	4.7		
	40	0.40	51	30	24	19.8	17.0	14.9	11.9	9.9	8.5	7.4	6.6	5.9	5.4		
	50	0.45	58	33	27	22	19.1	16.7	13.4	11.1	9.5	8.4	7.4	6.7	6.1		
	60	0.49	63	36	29	24	21	18.2	14.6	12.1	10.4	9.1	8.1	7.3	6.6		
	75	0.55	70	41	33	27	23	20	16.3	13.6	11.7	10.2	9.1	8.2	7.4		
90	0.60	77	45	36	30	25	22	17.8	14.9	12.7	11.1	9.9	8.9	8.1			
05	15	0.31	40	23	18.4	15.3	13.2	11.5	9.2	7.7	6.6	5.8	5.1	4.6	4.2		
	20	0.35	45	26	21	17.3	14.9	13.0	10.4	8.7	7.4	6.5	5.8	5.2	4.7		
	30	0.43	55	32	26	21	18.2	16.0	12.8	10.6	9.1	8.0	7.1	6.4	5.8		
	40	0.50	64	37	30	25	21	18.6	14.9	12.4	10.6	9.3	8.3	7.4	6.8		
	50	0.56	72	42	33	28	24	21	16.6	13.9	11.9	10.4	9.2	8.3	7.6		
	60	0.61	78	45	36	30	26	23	18.1	15.1	12.9	11.3	10.1	9.1	8.2		
	75	0.68	87	50	40	34	29	25	20	16.8	14.4	12.6	11.2	10.1	9.2		
90	0.75	96	56	45	37	32	28	22	18.6	15.9	13.9	12.4	11.1	10.1			
06	15	0.37	47	27	22	18.3	15.7	13.7	11.0	9.2	7.8	6.9	6.1	5.5	5.0		
	20	0.42	54	31	25	21	17.8	15.6	12.5	10.4	8.9	7.8	6.9	6.2	5.7		
	30	0.52	67	39	31	26	22	19.3	15.4	12.9	11.0	9.7	8.6	7.7	7.0		
	40	0.60	77	45	36	30	25	22	17.8	14.9	12.7	11.1	9.9	8.9	8.1		
	50	0.67	86	50	40	33	28	25	19.9	16.6	14.2	12.4	11.1	9.9	9.0		
	60	0.73	93	54	43	36	31	27	22	18.1	15.5	13.6	12.0	10.8	9.9		
	75	0.82	105	61	49	41	35	30	24	20	17.4	15.2	13.5	12.2	11.1		
90	0.90	115	67	53	45	38	33	27	22	19.1	16.7	14.9	13.4	12.2			
08	15	0.49	63	36	29	24	21	18.2	14.6	12.1	10.4	9.1	8.1	7.3	6.6		
	20	0.57	73	42	34	28	24	21	16.9	14.1	12.1	10.6	9.4	8.5	7.7		
	30	0.69	88	51	41	34	29	26	20	17.1	14.6	12.8	11.4	10.2	9.3		
	40	0.80	102	59	48	40	34	30	24	19.8	17.0	14.9	13.2	11.9	10.8		
	50	0.89	114	66	53	44	38	33	26	22	18.9	16.5	14.7	13.2	12.0		
	60	0.98	125	73	58	49	42	36	29	24	21	18.2	16.2	14.6	13.2		
	75	1.10	141	82	65	54	47	41	33	27	23	20	18.2	16.3	14.9		
90	1.20	154	89	71	59	51	45	36	30	25	22	19.8	17.8	16.2			
10	15	0.61	78	45	36	30	26	23	18.1	15.1	12.9	11.3	10.1	9.1	8.2		
	20	0.71	91	53	42	35	30	26	21	17.6	15.1	13.2	11.7	10.5	9.6		
	30	0.87	111	65	52	43	37	32	26	22	18.5	16.1	14.4	12.9	11.7		
	40	1.00	128	74	59	50	42	37	30	25	21	18.6	16.5	14.9	13.5		
	50	1.12	143	83	67	55	48	42	33	28	24	21	18.5	16.6	15.1		
	60	1.22	156	91	72	60	52	45	36	30	26	23	20	18.1	16.5		
	75	1.37	175	102	81	68	58	51	41	34	29	25	23	20	18.5		
90	1.50	192	111	89	74	64	56	45	37	32	28	25	22	20			
15	15	0.92	118	68	55	46	39	34	27	23	19.5	17.1	15.2	13.7	12.4		
	20	1.06	136	79	63	52	45	39	31	26	22	19.7	17.5	15.7	14.3		
	30	1.30	166	97	77	64	55	48	39	32	28	24	21	19.3	17.6		
	40	1.50	192	111	89	74	64	56	45	37	32	28	25	22	20		
	50	1.68	215	125	100	83	71	62	50	42	36	31	28	25	23		
	60	1.84	236	137	109	91	78	68	55	46	39	34	30	27	25		
	75	2.05	262	152	122	101	87	76	61	51	43	38	34	30	28		
90	2.25	288	167	134	111	95	84	67	56	48	42	37	33	30			
20	15	1.22	156	91	72	60	52	45	36	30	26	23	20	18.1	16.5		
	20	1.41	180	105	84	70	60	52	42	35	30	26	23	21	19.0		
	30	1.73	221	128	103	86	73	64	51	43	37	32	29	26	23		
	40	2.00	256	149	119	99	85	74	59	50	42	37	33	30	27		
	50	2.24	287	166	13												

NOZZLE PERFORMANCE CHART 50CM SPACING

Universal Application Rate Chart for 50 cm Tip Spacing

TIP CAPACITY	LIQUID PRESSURE IN bar	CAPACITY 1 NOZZLE IN l/min	l/ha - 50 cm NOZZLE SPACING												
			4 km/h	6 km/h	8 km/h	10 km/h	12 km/h	14 km/h	16 km/h	18 km/h	20 km/h	25 km/h	30 km/h	35 km/h	
01	1.0	0.23	69.0	46.0	34.5	27.6	23.0	19.7	17.3	15.3	13.8	11.0	9.2	7.9	
	1.5	0.28	84.0	56.0	42.0	33.6	28.0	24.0	21.0	18.7	16.8	13.4	11.2	9.6	
	2.0	0.32	96.0	64.0	48.0	38.4	32.0	27.4	24.0	21.3	19.2	15.4	12.8	11.0	
	3.0	0.39	117	78.0	58.5	46.8	39.0	33.4	29.3	26.0	23.4	18.7	15.6	13.4	
	4.0	0.45	135	90.0	67.5	54.0	45.0	38.6	33.8	30.0	27.0	21.6	18.0	15.4	
	5.0	0.50	150	100	75.0	60.0	50.0	42.9	37.5	33.3	30.0	24.0	20.0	17.1	
	6.0	0.55	165	110	82.5	66.0	55.0	47.1	41.3	36.7	33.0	26.4	22.0	18.9	
7.0	0.60	180	120	90.0	72.0	60.0	51.4	45.0	40.0	36.0	28.8	24.0	20.6		
015	1.0	0.34	102	68.0	51.0	40.8	34.0	29.1	25.5	22.7	20.4	16.3	13.6	11.7	
	1.5	0.42	126	84.0	63.0	50.4	42.0	36.0	31.5	28.0	25.2	20.2	16.8	14.4	
	2.0	0.48	144	96.0	72.0	57.6	48.0	41.1	36.0	32.0	28.8	23.0	19.2	16.5	
	3.0	0.59	177	118	88.5	70.8	59.0	50.6	44.3	39.3	35.4	28.3	23.6	20.2	
	4.0	0.68	204	136	102	81.6	68.0	58.3	51.0	45.3	40.8	32.6	27.2	23.3	
	5.0	0.76	228	152	114	91.2	76.0	65.1	57.0	50.7	45.6	36.5	30.4	26.1	
	6.0	0.83	249	166	125	99.6	83.0	71.1	62.3	55.3	49.8	39.8	33.2	28.5	
7.0	0.90	270	180	135	108	90.0	77.1	67.5	60.0	54.0	43.2	36.0	30.9		
02	1.0	0.46	138	92.0	69.0	55.2	46.0	39.4	34.5	30.7	27.6	22.1	18.4	15.8	
	1.5	0.56	168	112	84.0	67.2	56.0	48.0	42.0	37.3	33.6	26.9	22.4	19.2	
	2.0	0.65	195	130	97.5	78.0	65.0	55.7	48.8	43.3	39.0	31.2	26.0	22.3	
	3.0	0.79	237	158	119	94.8	79.0	67.7	59.3	52.7	47.4	37.9	31.6	27.1	
	4.0	0.91	273	182	137	109	91.0	78.0	68.3	60.7	54.6	43.7	36.4	31.2	
	5.0	1.02	306	204	153	122	102	87.4	76.5	68.0	61.2	49.0	40.8	35.0	
	6.0	1.12	336	224	168	134	112	96.0	84.0	74.7	67.2	53.8	44.8	38.4	
7.0	1.21	363	242	182	145	121	104	90.8	80.7	72.6	58.1	48.4	41.5		
025	1.0	0.57	171	114	85.5	68.4	57.0	48.9	42.8	38.0	34.2	27.4	22.8	19.5	
	1.5	0.70	210	140	105	84.0	70.0	60.0	52.5	46.7	42.0	33.6	28.0	24.0	
	2.0	0.81	243	162	122	97.2	81.0	69.4	60.8	54.0	48.6	38.9	32.4	27.8	
	3.0	0.99	297	198	149	119	99.0	84.9	74.3	66.0	59.4	47.5	39.6	33.9	
	4.0	1.14	342	228	171	137	114	97.7	85.5	76.0	68.4	54.7	45.6	39.1	
	5.0	1.28	384	256	192	154	128	110	96.0	85.3	76.8	61.4	51.2	43.9	
	6.0	1.40	420	280	210	168	140	120	105	93.3	84.0	67.2	56.0	48.0	
7.0	1.51	453	302	227	181	151	129	113	101	90.6	72.5	60.4	51.8		
03	1.0	0.68	204	136	102	81.6	68.0	58.3	51.0	45.3	40.8	32.6	27.2	23.3	
	1.5	0.83	249	166	125	99.6	83.0	71.1	62.3	55.3	49.8	39.8	33.2	28.5	
	2.0	0.96	288	192	144	115	96.0	82.3	72.0	64.0	57.6	46.1	38.4	32.9	
	3.0	1.18	354	236	177	142	118	101	88.5	78.7	70.8	56.6	47.2	40.5	
	4.0	1.36	408	272	204	163	136	117	102	90.7	81.6	65.3	54.4	46.6	
	5.0	1.52	456	304	228	182	152	130	114	101	91.2	73.0	60.8	52.1	
	6.0	1.67	501	334	251	200	167	143	125	111	100	80.2	66.8	57.3	
7.0	1.80	540	360	270	216	180	154	135	120	108	86.4	72.0	61.7		
04	1.0	0.91	273	182	137	109	91.0	78.0	68.3	60.7	54.6	43.7	36.4	31.2	
	1.5	1.12	336	224	168	134	112	96.0	84.0	74.7	67.2	53.8	44.8	38.4	
	2.0	1.29	387	258	194	155	129	111	96.8	86.0	77.4	61.9	51.6	44.2	
	3.0	1.58	474	316	237	190	158	135	119	105	94.8	75.8	63.2	54.2	
	4.0	1.82	546	364	273	218	182	156	137	121	109	87.4	72.8	62.4	
	5.0	2.04	612	408	306	245	204	175	153	136	122	97.9	81.6	69.9	
	6.0	2.23	669	446	335	268	223	191	167	149	134	107	89.2	76.5	
7.0	2.41	723	482	362	289	241	207	181	161	145	116	96.4	82.6		
05	1.0	1.14	342	228	171	137	114	97.7	85.5	76.0	68.4	54.7	45.6	39.1	
	1.5	1.39	417	278	209	167	139	119	104	92.7	83.4	66.7	55.6	47.7	
	2.0	1.61	483	322	242	193	161	138	121	107	96.6	77.3	64.4	55.2	
	3.0	1.97	591	394	296	236	197	169	148	131	118	94.6	78.8	67.5	
	4.0	2.27	681	454	341	272	227	195	170	151	136	109	90.8	77.8	
	5.0	2.54	762	508	381	305	254	218	191	169	152	122	102	87.1	
	6.0	2.79	837	558	419	335	279	239	209	186	167	134	112	95.7	
7.0	3.01	903	602	452	361	301	258	226	201	181	144	120	103		
06	1.0	1.37	411	274	206	164	137	117	103	91.3	82.2	65.8	54.8	47.0	
	1.5	1.68	504	336	252	202	168	144	126	112	101	80.6	67.2	57.6	
	2.0	1.94	582	388	291	233	194	166	146	129	116	93.1	77.6	66.5	
	3.0	2.37	711	474	356	284	237	203	178	158	142	114	94.8	81.3	
	4.0	2.74	822	548	411	329	274	235	206	183	164	132	110	93.9	
	5.0	3.06	918	612	459	367	306	262	230	204	184	147	122	105	
	6.0	3.35	1005	670	503	402	335	287	251	223	201	161	134	115	
7.0	3.62	1086	724	543	434	362	310	272	241	217	174	145	124		
08	1.0	1.82	546	364	273	218	182	156	137	121	109	87.4	72.8	62.4	
	1.5	2.23	669	446	335	268	223	191	167	149	134	107	89.2	76.5	
	2.0	2.58	774	516	387	310	258	221	194	172	155	124	103	88.5	
	3.0	3.16	948	632	474	379	316	271	237	211	190	152	126	108	
	4.0	3.65	1095	730	548	438	365	313	274	243	219	175	146	125	
	5.0	4.08	1224	816	612	490	408	350	306	272	245	196	163	140	
	6.0	4.47	1341	894	671	536	447	383	335	298	268	215	179	153	
7.0	4.83	1449	966	725	580	483	414	362	322	290	232	193	166		
10	1.0	2.28	684	456	342	274	228	195	171	152	137	109	91.2	78.2	
	1.5	2.79	837	558	419	335	279	239	209	186	167	134	112	95.7	
	2.0	3.23	969	646	485	388	323	277	242	215	194	155	129	111	
	3.0	3.95	1185	790	593	474	395	339	296	263	237	190	158	135	
	4.0	4.56	1368	912	684	547	456	391	342	304	274	219	182	156	
	5.0	5.10	1530	1020	765	612	510	437	383	340	306	245	204	175	
	6.0	5.59	1677	1118	839	671	559	479	419	373	335	268	224	192	
7.0	6.03	1809	1206	905	724	603	517	452	402	362	289	241	207		
15	1.0	3.42	1026	684	513	410	342	293	257	228	205	164	137	117	
	1.5	4.19	1257	838	629	503	419	359	314	279	251	201	168	144	
	2.0	4.83	1449	966	725	580	483	414	362	322	290	232	193	166	
	3.0	5.92	1776	1184	888	710	592	507	444	395	355	284	237	203	
	4.0	6.84	2052	1368	1026	821	684	586	513	456	410	328	274	235	
	5.0	7.64	2292	1528	1146	917	764	655	573	509	458	367	306	262	
	6.0	8.37	2511	1674	1256	1004	837	717	628	558	502	402	335	287	
7.0	9.04	2712	1808	1356	1085	904	775	678	603	542	434	362	310		
20	1.0	4.56	1368	912	684	547	456	391	342	304	274	219	182	156	
	1.5	5.58	1674	1116	837	670	558	478	419	372	335	268	223	191	
	2.0	6.44	1932	1288	966	773	644	552	483	429	386	309	258	221	
	3.0	7.89	2367	1578	1184	947	789	676	592	526	473	379	316	271	
	4.0	9.11	2733	1822	1367	1093	911	781	683	607	547	437	364	312	
	5.0	10.19	3057	2038	1529	1223	1019	873	764	679	611	489	408	349	
	6.0	11.16	3348	2232	1674	1339	1116	957	837	744	670	536	446	383	
7.0	12.05	3615	2410	1808	1446	1205	1033	904	803	723	578	482	413		

ABBREVIATIONS AND CONVERSIONS

gpm	Gallons per minute	cm	Centimeters
lit/min	Liters per minute	dm	Decimeters
dl/min	Deciliter per minute	m	Meter
psi	Pounds per square inch	mm	Millimeters
km	Kilometers	m.p.h.	Miles per hour
GPA	Gallon per acre	km/h	Kilometers per hour
lit/ha	Liters per hectare	us	Volume per ACRE
ml/ha	Milliliter per hectare	Si	Volume per hectare
gpk	Gallons per 1,000 sq ft	TU	Volume per 1,000 sq ft

AREA & SPEED

Distance (feet) x 0.68 = Travel Speed (m.p.h.) Travel Time (seconds)

Time Required in Seconds to Travel a Distance of:

Speed (m.p.h.)	100 Ft	200 Ft	300 Ft
1.0	68	136	205
1.5	46	92	136
2.0	34	68	103
2.5	27	54	82
3.0	23	46	68
3.5	20	40	58
4.0	17	34	52
4.5	15	30	46
5.0	13	28	41

LIQUID/VOLUME

1 US Gallon x 128 = Fluid Ounces

1 US Gallon x 3.785 = Liters

1 US Gallon x 0.83267 = Imperial Gallons

1 US Gallon x 8.34 = Pounds (Water)

1 Gallon Per Acre = 2.9 Fluid Ounces per 1,000 Square Feet = 9.35 Liters Per Hectare

1 Gallon Per 1,000 Square Feet = 43.56 Gallons Per Acre

1 Gallon = 128 Fluid Ounces = 8 Pints = 4 Quarts = 3.79 Liters = 0.83 Imperial Gallons

$$\text{GPA} = \frac{5940 \times \text{GPM (per nozzle)}}{\text{MPH} \times \text{W(nozzle spacing)}}$$

$$\text{GAL. 1,000 Square Feet} = \frac{136 \times \text{GPM (per nozzle)}}{\text{MPH} \times \text{W(nozzle spacing)}}$$

LENGTH/DISTANCE

1 millimeter (mm) = 0.039 inch

1 centimeter (cm) = 0.393 inch

1 meter (m) = 3.281 feet

1 kilometer (km) = 0.621 mile

1 inch = 25.4 millimeters; 2.54 centimeters

1 mile = 5280 Feet = 1610 Meters = 1.609 Kilometers

RE-CALIBRATE FLOWMETER

$$\text{Corrected Meter Cal number} = \frac{\text{Meter Cal} \times \text{Total Volume}}{\text{Predetermined amount of measured liquid}}$$

DECLARATION OF CONFORMITY • ДЕКЛАРАЦИЯ ЗА СЪОТВЕТСТВИЕ • PROHLÁŠENÍ O SHODĚ • OVERENSSTEMMELSESERKLÆRING • CONFORMITEITSVERKLARING • VASTAVUSDEKLARATSIOON • VAATIMUSTENMUKAISUUSVAKUUTUS • DECLARATION DE CONFORMITE • KONFORMITÄTSEKTLÄRUNG • ΔΗΛΩΣΗ ΣΥΜΜΟΡΦΩΣΗΣ • MEGFELELŐSÉGI NYILATKOZAT • DICHIARAZIONE DI CONFORMITÀ • ATBILSTĪBAS DEKLARĀCIJA • ATITIKTIYES DEKLARACIJA • DIKJARAZJONI TAL-KONFORMITÀ • DEKLARACJA ZGODNOŚCI • DECLARAÇÃO DE CONFORMIDADE • DECLARAȚIE DE CONFORMITATE • VYHLÁSENIE O ZHODE • IZJAVA O SKLADNOSTI • DECLARACIÓN DE CONFORMIDAD • DEKLARATION OM ÖVERENSSTÄMMELSE

Business name and full address of the manufacturer • Търговско име и пълен адрес на производителя • Obchodní jméno a plná adresa výrobce • Producentens firmanavn og fulde adresse • Bedrijfsnaam en volledige adres van de fabrikant • Toetja ärinimi ja täielik address • Valmistajan toiminimi ja täydellinen osoite • Nom commercial et adresse complète du fabricant • Firmenname und vollständige Adresse des Herstellers • Επωνυμία και ταχυδρομική διεύθυνση κατασκευαστή • A gyártó üzleti neve és teljes címe • Ragione sociale e indirizzo completo del fabbricante • Uzņēmuma nosaukums un pilna ražotāja adrese • Verslo pavadinimas ir pilnas gamintojo adresas • Isem kummerčiali u indirizz shih tal-fabbrikant • Nazwa firmy i pełny adres producenta • Nome da empresa e endereço completo do fabricante • Denumirea comercială și adresa completă a producătorului • Obchodný názov a úplná adresa výrobcu • Naziv podjetja in polni naslov proizvajalca • Nombre de la empresa y dirección completa del fabricante • Tillverkarens företagsnamn och kompletta adress	Smithco Inc. 34 West Avenue Wayne, PA USA 19087-3311
Product Code • Код на продукта • Kód výrobku • Produktkode • Productcode • Toote kood • Tuotekoodi • Code produit • Produktcode • Κωδικός προϊόντος • Termékkód • Codice prodotto • Produkta kods • Produkto kodas • Kodići tal-Prodott • Kod produktu • Código do Produto • Cod produs • Kód výrobku • Označka proizvoda • Código de producto • Produktkod	15-600
Machine Name • Наименование на машината • Název stroje • Maskinnavn • Machine naam • Masina nimi • Laitteen nimi • Nom de la machine • Maschinenbezeichnung • Ονομασία μηχανήματος • Gébrén • Denominazione della macchina • Iekārtas nosaukums • Mašinos pavadinimas • Isem tal-Magna • Nazwa urządzenia • Nome da Máquina • Numele echipamentului • Názov stroja • Naziv stroja • Nombre de la máquina • Maskinens namn	Spray Star 1750
Designation • Предназначение • Označení • Betegnelse • Benaming • Nimetus • Tyypimerkintä • Pažymėjimas • Bezeichnung • Χαρακτηρισμός • Megnevezés • Funzione • Apzīmējums • Lithuanian • Denominazzjoni • Oznaczenie • Designação • Specificație • Označenie • Namen stroja • Descripción • Beteckning	Turf Sprayer
Serial Number • Серийн номер • Sériové číslo • Seriennummer • Seriennummer • Seerianumber • Valmistusnumero • Numéro de série • Seriennummer • Σειριακός αριθμός • Sorozatszám • Numero di serie • Sérijas numurs • Serijos numeris • Numru Serjali • Numer seryjny • Número de Série • Numár de serie • Sériový číslo • Serijska številka • Número de serie • Seriennummer	175G353 - 175G700
Engine • Двигател • Motor • Motor • Motor • Mootor • Mootori • Moteur • Motor • Μηχανή • Modulnė • Motore • Dzinējs • Variklis • Sahha Netta Installata • Silnik • Motor • Motor • Motor • Motor • Motor • Motor	Briggs & Stratton 543477
Net Installed Power • Нетна инсталирана мощност • Cistý instalovaný výkon • Installeret nettoeffekt • Netto geïnstalleerd vermogen • Installeeritud netovõimsus • Asennettu nettoteho • Puissance nominale nette • Installierte Nettoleistung • Καθαρή εγκατεστημένη ισχύς • Nettó beépített teljesítmény • Potenza netta installata • Paredzētā tīkla jauda • Grynoji galia • Wisa' tal-Qtugh • Moc zainstalowana netto • Potência instalada • Puterea instalată netă • Cistý instalovaný výkon • Neto vgrajena moč • Potencia instalada neta • Nettoeffekt	26 kW
Conforms to Directives • В съответствие с директивите • Splūņuje podmiņky smērnīc • Er i overensstemmelse med direktiver • Voldoet aan de richtlijnen • Vastab direktiividele • Direktiivien mukainen • Conforme aux directives • Entspricht Richtlinien • Ακολουθείτε πιστά τις Οδηγίες • Megfelel az irányelveknek • Conforme alle Direttive • Atbilst direktīvām • Atitinka direktyvų reikalavimus • Valutazzjoni tal-Konformità • Dyrektywy związane • Cumpre as Directivas • Respectă Directivele • Je v súlade so smernicami • Skladnost z direktivami • Cumple con las Directivas • Iupnfuler direktiv	2006/42/EC; 2000/14/EC Annex VI . Part 1
Conformity Assessment • Оценка за съответствие • Hodnocení plnění podmínek • Overensstemmelsesvurdering • Conformiteitsbeoordeling • Vastavushindamine • Vaatimustenmukaisuuden arviointi • Evaluation de conformité • Konformitätsbeurteilung • Διαπίστωση Συμμόρφωσης • Megfelelőség-értékelés • Valutazione della conformità • Atbilstības novērtējums • Atitikties įvertinimas • Livell tal-Qawwa tal-Hoss Imkejjel • Ocena zgodności • Avaliação de Conformidade • Evaluarea conformității • Vyhodnotenie zhodnosti • Ocena skladnosti • Evaluación de conformidad • Bedömning av överensstämmelse	2006/42/EC Annex VIII
Measured Sound Power Level • Измерено ниво на звукова мощност • Naměřený akustický výkon • Målte lydstyrkeniveau • Gemeten geluidsniveau • Mõdetud helivõimsuse tase • Mitattu äänitehotaso • Niveau de puissance sonore mesuré • Gemessener Schalldruckpegel • Σταθμισμένο επίπεδο ηχητικής ισχύος • Mért hangteljesítményszint • Livello di potenza sonora misurato • Izmērtais skaņas jaudas līmenis • Išmatuotas garso stiprumo lygis • Livell tal-Qawwa tal-Hoss Iggarantit • Moc akustyczna mierzona • Nivel sonoro medido • Nivelul măsurat al puterii acustice • Nameranā hlada akustického výkonu • Izmerjena raven zvočne moči • Nivel de potencia sonora medido • Uppmätt ljudeffektnivå	96dB(A)Lwa
Guaranteed Sound Power Level • Гарантирано ниво на звукова мощност • Garantovaný akustický výkon • Garanteret lydstyrkeniveau • Gegaranteed geluidsniveau • Garantierud helivõimsuse tase • Taattu äänitehotaso • Niveau de puissance sonore garanti • Garanterter Schalldruckpegel • Εγγυημένο επίπεδο ηχητικής ισχύος • Szavatolt hangteljesítményszint • Livello di potenza sonora garantito • Garantėtais skaņas jaudas līmenis • Garantuotas garso stiprumo lygis • Livell tal-Qawwa tal-Hoss Iggarantit • Moc akustyczna gwarantowana • Nivel sonoro farantido • Nivelul garantat al puterii acustice • Garantovaná hlada akustického výkonu • Zajamčena raven zvočne moči • Nivel de potencia sonora garantizado • Garanterad ljudeffektnivå	98 dB(A)Lwa
Conformity Assessment Procedure (Noise) • Оценка за съответствие на процедурата (Шум) • Postup hodnocení plnění podmínek (hluk) • Procedure for overensstemmelsesvurdering (Støj) • Procedure van de conformiteitsbeoordeling (geluid) • Vastavushindamisemenetus (müra) • Vaatimustenmukaisuuden arviointimenetely (Melu) • Procédure d'évaluation de conformité (bruit) • Konformitätsbeurteilungsverfahren (Geräusch) • Διαδικασία Αξιολόγησης Συμμόρφωσης (Θόρυβος) • Megfelelőség-értékelési eljárás (Zaj) • Procedura di valutazione della conformità (rumore) • Atbilstības novērtējuma procedūra (troksnis) • Atitikties įvertinimo procedūra (garsas) • Procedura tal-Valutazzjoni tal-Konformità (Hoss) • Procedura oceny zgodności (poziom hałas) • Processo de avaliação de conformidade (nível sonoro) • Procedura de evaluare a conformității (zgomot) • Postup vyhodnocovania zhodnosti (hluk) • Postopek za ugotavljanje skladnosti (hrup) • Procedimiento de evaluación de conformidad (ruido) • Procedur för bedömning av överensstämmelse (buller)	2000/14/EC Annex VI Part 1
UK Notified Body for 2000/14/EC • Нотифициран орган в Обединеното кралство за 2000/14/EO • Úřad certifikovaný podle směrnice č. 2000/14/EC • Det britiske bemyndigede organ for 2001/14/EF • Engels adviesorgaan voor 2000/14/EG • Ühendkuningriigi teavitatud asutus direktiivi 2000/14/EÜ mõistes • Direktiivin 2000/14/EY mukainen ilmoitettu tarkastuslaitos Iosssa-Britanniassa • Organisme notifié concernant la directive 2000/14/CE • Britische benannte Stelle für 2000/14/EG • Κοινοποιημένος Οργανισμός Ηνωμένου Βασιλείου για 2000/14/EK • 2000/14/EK – egyesült királyságbeli bejelentett szervezet • Organismo Notificato in GB per 2000/14/CE • 2000/14/EK AK registrētā organizācija • JK notifikuotos istaigos 2000/14/EC • Korp Notifikat tar-Renju Unit ghal 2000/14/KE • Dopuszczona jednostka badawcza w Wielkiej Brytanii wg 2000/14/WE • Entidade notificada no Reino Unido para 2000/14/CE • Organism notificat în Marea Britanie pentru 2000/14/CE • Notifikovaný orgán Spojeného královstva pre smernicu 2000/14/ES • Britanski prijavljeni organ za 2000/14/ES • Cierpo notificado en el Reino Unido para 2000/14/CE • Amplifikator für 2000/14/EC i Notifikovaný	Smithco West Inc. 200 West Poplar Avenue Cameron, WI 54822 USA
Operator Ear Noise Level • Оператор на нивото на доловим от ухото шум • Hlada hluku v oblasti uší operátora • Stojniveau i førers ørehøjde • Geluidsniveau oor bestuurder • Mõratase operaatori kõrvas • Melutaso käyttäjän korvan kohdalla • Niveau de bruit à hauteur des oreilles de l'opérateur • Schallpegel am Bedienerohr • Επίπεδο θορύβου σε λειτουργία • A kezelő fülénél mért zajszint • Livello di potenza sonora all'orecchio dell'operatore • Trokšņa līmenis pie operatora auss • Dirbančiojo su mašina patiriamio triukšmo lygis • Livell tal-Hoss fil-Widna tal-Operatur • Dopuszczalny poziom hałasu dla operatora • Nivel sonoro nos ouvidos do operador • Nivelul zgomotului la urechea operatorului • Hlada hluku pôsobiaci na sluch operátora • Raven hrupa pri užesu upravljavca • Nivel sonoro en el oído del operador • Ljudnivå vid förarens öra	96 dB(A)Lwa (2006/42/EC)

Reference



<p>Harmonised standards used • Използвани хармонизирани стандарти • Použité harmonizované normy • Brugte harmoniserede standarder • Gebroekte geharmoniseerde standaards • Kasutatud ühtlustatud standardid • Käytetyt yhdenmukaistetut standardit • Normes harmonisées utilisées • Angewandte harmonisierte Normen • Εναρμονισμένα πρότυπα που χρησιμοποιήθηκαν • Harmonizált szabványok • Standard armonizzati applicati • Izmantotie saskaņotie standarti • Panaudoti suderinti standartai • Standards armonizzati usati • Normy spójne powiązane • Normas harmonizadas usadas • Standardele armonizate utilizate • Použité harmonizované normy • Uporabljene usklajeni standardi • Estándares armonizados utilizados • Harmoniserade standarder som används</p>	<p>ANSI/OPEI B71.4:2012 BS EN ISO 13857 BS EN 349: 1993+A1:2008 BS 6356: P8 BS 6356:P5 BSEN ISO 4254-6</p>
<p>Technical standards and specifications used • Използвани технически стандарти и спецификации • Použité technické normy a specifikace • Brugte tekniske standarder og specifikationer • Gebroekte technische standaards en specificaties • Kasutatud tehnilised standardid ja spetsifikatsioonid • Käytetyt tekniset standardit ja eritelmät • Spécifications et normes techniques utilisées • Angewandte technische Normen und Spezifikationen • Τεχνικά πρότυπα και προδιαγραφές που χρησιμοποιήθηκαν • Műszaki szabványok és specifikációk • Standard tecnici e specifiche applicati • Izmantotie tehniskie standarti un specifikkācijas • Panaudoti techniniai standartai ir techninė informacija • Standards u specifikkazzjonnijet technici užati • Normy i specyfikacje techniczne powiązane • Normas técnicas e especificações usadas • Standardele tehnice și specificațiile utilizate • Použité technické normy a špecifikácie • Uporabljene tehnični standardi in specifikacije • Estándares y especificaciones técnicas utilizadas • Tekniska standarder och specifikationer som används</p>	<p>ISO 21299 2002/44/EC ISO 3767-1</p>
<p>The place and date of the declaration • Място и дата на декларацията • Místo a datum prohlášení • Sted og dato for erklæringen • Plaats en datum van de verklaring • Deklaratsiooni väljastamise koht ja kuupäev • Vakuutuksen paikka ja päivämäärä • Lieu et date de la déclaration • Ort und Datum der Erklärung • Τόπος και ημερομηνία δήλωσης • A nyilatkozat kelte (hely és idő) • Luogo e data della dichiarazione • Deklarācijas vieta un datums • Deklaracijos vieta ir data • Il-post u d-data tad-dikjarazzjoni • Miejsce i data wystawienia deklaracji • Local e data da declaração • Locul și data declarației • Miesto a dátum vyhlášení • Kraj in datum izjave • Lugar y fecha de la declaración • Plats och datum för deklarationen</p>	<p>Smithco West Inc. 200 West Poplar Avenue Cameron, WI 54822 USA 19-Nov-19</p>
<p>Signature of the person empowered to draw up the declaration on behalf of the manufacturer, holds the technical documentation and is authorised to compile the technical file, and who is established in the Community. Подпис на човека, упълномощен да състави декларацията от името на производителя, който поддържа техническата документация и е оторизиран да изготви техническия файл и е регистриран в общността. Podpis osoby oprávněné sestavit prohlášení jménem výrobce, držet technickou dokumentaci a osoby oprávněné sestavit technické soubory a založené v rámci Evropského společenství. Underskrift af personen, der har fuldmagt til at udarbejde erklæringen på vegne af producenten, der er indehaver af dokumentationen og er bemyndiget til at udarbejde den tekniske journal, og som er baseret i nærområdet. Handtekening van de persoon die bevoegd is de verklaring namens de fabrikant te tekenen, de technisch documentatie bewaart en bevoegd is om het technische bestand samen te stellen, en die is gevestigd in het Woongebied. Ühenduse registrisse kantud isiku allkiri, kes on volitatud tootja nimel deklaratsiooni koostama, kes omab tehnilisdokumentatsiooni ja kellel on õigus koostada tehnilise toimik. Sen henkilö allekirjoitus, jolla on valmistajan valtuutus vakuutuksen laadintaan, jolla on hallussaan teknisetasiakirjat, joka on valtuutettu laatimaan tekniset asiakirjat ja joka on sijoittautunut yhteisöön. Signature de la personne habilitée à rédiger la déclaration au nom du fabricant, à détenir la documentation technique, à compiler les fichiers techniques et qui est implantée dans la Communauté. Unterschrift der Person, die berechtigt ist, die Erklärung im Namen des Herstellers abzugeben, die die technischen Unterlagen aufbewahrt und berechtigt ist, die technischen Unterlagen zusammenzustellen, und die in der Gemeinschaft niedergelassen ist. Υπογραφή ατόμου εξουσιοδοτημένου για την σύνταξη της δήλωσης εκ μέρους του κατασκευαστή, ο οποίος κατέχει την τεχνική έκθεση και έχει την εξουσιοδότηση να ταξινόμησει τον τεχνικό φάκελο και ο οποίος είναι διορισμένος στην Κοινότητα. A gyártó nevében meghatalmazott személy, akinek jogában áll módosítania a nyilatkozatot, a műszaki dokumentációt őrizi, engedéllyel rendelkezik a műszaki fájl összeállításához, és aki a közösségben telepedett személy. Firma della persona autorizzata a redigere la dichiarazione a nome del fabbricante, in possesso della documentazione tecnica ed autorizzata a costituire il fascicolo tecnico, che deve essere stabilita nella Comunità. Tās personas paraksts, kura ir pilnvarota deklarācijas sastādīšanai ražotāja vārdā, kurai ir tehniskā dokumentācija, kura ir pilnvarota sagatavot tehnisko reģistru un kura ir apstiprināta Kopienā. Asmuo, kuris yra gana žinomas, kuriam gamintojas suteikė įgaliojimus sudaryti šią deklaraciją, ir kuris įspasirašė, turi visą techninę informaciją ir yra įgaliojotas sudaryti techninės informacijos dokumentą. Il-firma tal-persuna awtorizzata li tfassal id-dikjarazzjoni fisem il-fabrikant, għandha d-dokumentazzjoni teknika u hija awtorizzata li tikkompila l-fajl tekniku u li hija stabbilita fil-Komunità. Podpis osoby upoważnionej do sporządzenia deklaracji w imieniu producenta, przechowującej dokumentację techniczną, upoważnionej do stworzenia dokumentacji technicznej oraz wyznaczonej ds. wspólnotowych. Assinatura da pessoa com poderes para emitir a declaração em nome do fabricante, que possui a documentação técnica, que está autorizada a compilar o processo técnico e que está estabelecida na Comunidade. Semnătura persoanei împuternicite să elaboreze declarația în numele producătorului, care deține documentația tehnică, este autorizată să compileze dosarul tehnic și este stabilită în Comunitate. Podpis osoby poverenej vystavením vyhlášení v mene výrobcu, ktorá má technickú dokumentáciu a je oprávnená spracovať technické podklady a ktorá je umiestnená v Spoločenstve. Podpis osebe, pooblaščene za izdelavo izjave v imenu proizvajalca, ki ima tehnično dokumentacijo in lahko sestavlja spis tehnične dokumentacije, ter ima sedež v Skupnosti. Firma de la persona responsable de la declaración en nombre del fabricante, que posee la documentación técnica y está autorizada para recopilar el archivo técnico y que está establecido en la Comunidad. Undertecknas av den som bemyndigad att upprätta deklarationen å tillverkarens vägnar, innehar den tekniskadokumentationen och är bemyndigad att sammanställa den tekniska informationen och som är etablerad i gemenskapen.</p>	<p>2006/42/EC Annex II 1A: 2 John Moore Sales, Director, Owner Moore Turf Care Thieplatz 4 49583 Lienen Germany 23-Sep-19</p> <p>2006/42/EC Annex II 1A: 10 Dawn Bryngelson Technical Documentation Advisor Smithco Inc. 34 West Avenue Wayne, PA USA 19087-3311 10-Dec-09</p>
<p>Certificate Number • Номер на сертификат • Číslo osvědčení • Certifikatnummer • Certificaatnummer • Sertifikaadi number • Huväksyntänumero • Numéro de certificat • Bescheinigungsnummer • Αριθμός Πιστοποιητικού • Hitelesítési szám • Numero del certificato • Serifikata numers • Serifikato numeris • Numru tač-Certifikat • Numer certyfikatu • Número do Certificado • Număr certificat • Číslo osvědčenia • Številka certifikata • Número de certificado • Certifikatsnummer</p>	<p>156002020-1</p>



Reference

QUICK REFERENCE REPLACEMENT PARTS

REPLACEMENT FILTERS

23-031	Hydraulic Oil Filter	
76-487	Engine Oil Filter	Briggs # 842921
76-395-01	Air Cleaner Cartridge	Briggs # 841497
76-395-02	Safety Filter Cartridge	Briggs # 821136
13-488	Key Switch	
76-310	Key Set	
50-403	Inline Fuel Filter	

REPLACEMENT BELTS

15-704	Spray Pump Belt
--------	-----------------

SEAL KITS

15-301	Power Steering Orbital Motor
15-301-01	Seal Kit
15-839	Hydraulic Cylinder
14-531	Seal Kit
11-158	Linear Actuators
11-158-01	Seal Kit
76-238	Wheel Motors
14-080	Seal Kit
76-398	Hydrostatic Pump
77-239-22	Seal Kit
76-197	Gear Pump
76-197-08	Seal Kit

FLUIDS

Engine Oil	SAE 10W-40 API Service SJ or higher Motor Oil
Hydraulic Fluid	SAE 10W-40 API Service SJ or higher Motor Oil

OTHER PARTS

16-953	Hinged Cover On Tank with Gasket	
16-953-01	Gasket For Cover	
16-169	Strainer Basket	
15-818	#75 Fitting Oring	
15-817	#50 Fitting Oring	
	Spark Plugs	Champion type RC12YC (Gap 0.040 inch (1.02mm))

The Smithco Commercial Products Two-Year Limited Warranty

Smithco, Inc. (Smithco) warrants your 2016 or newer Smithco Commercial Product (“Product”) purchased after October 1, 2016 to be free from defects in materials or workmanship for the period of time listed below. Where a warrantable condition exists, Smithco will repair the Product at no cost to you including diagnosis, labor (at the Smithco standard labor rate, subject to the Smithco flat rate schedule), and parts.

Warranty Duration is:

- (1) Two years, 1500 operational hours* from the date of delivery to the original purchaser or Five years from the date of original manufacturer of the product, whichever occurs first. (*Products equipped with hour meter).
- (2) Products used in rental situations are covered for 90 days from date of delivery to original user/renter.

Owner Responsibilities:

As the Product owner, you are responsible for required maintenance and adjustments stated in your Owner’s Manual. Failure to perform required maintenance and adjustments can be grounds for disallowing a warranty claim. **You are particularly responsible to train all present and future operators of this product on the safe operation of this product at your location.**

Instructions for Obtaining Warranty Service:

You are responsible for notifying the Authorized Smithco Products Distributor from whom you purchased the Product as soon as you believe a warrantable condition exists and not later than 30 days from discovery of the condition.

If you need help locating an Authorized Smithco Distributor, or if you have questions regarding your warranty rights or responsibilities, you may contact us at:

Smithco Product Support Department
200 West Poplar Ave.
Cameron, Wisconsin 54822
Telephone: 800-891-9435 E-Mail: ProductSupport@Smithco.com

Maintenance Parts:

Parts scheduled for replacement as required maintenance (“Maintenance Parts”), are warranted for the period of time up to the scheduled replacement time for that part.

Items/Conditions Not Covered:

Not all product failures or malfunctions that occur during the warranty period are defects in materials or workmanship. The items/conditions listed below are not covered by this warranty:



Product failures which result from the use of non-Smithco replacement parts, or from installation and use of add-on, modified, or unapproved accessories are not covered.



Product failures which result from failure to perform required maintenance and/or adjustments are not covered.



Product failures that result from operating the Product in an abusive, negligent or reckless manner are not covered.



This warranty does not apply to parts subject to consumption through use, unless found to be defective. Examples of parts which are consumed, or used up, during normal Product operation include, but are not limited to: blades, tines, teeth, scarifiers, rakes, plates, wear plates, castor wheels, tires, batteries, filters, belts, nozzles, etc.



This warranty does not apply to failures caused by outside influence. Items considered to be outside influence include, but are not limited to, weather, storage practices, contamination, use of unapproved coolants, lubricants, additives, or chemicals, etc.



This warranty does not apply to normal “wear and tear” items. Normal “Wear and Tear” includes, but is not limited to, damage to seats due to wear or abrasion, worn painted surfaces, scratched decals or windows, etc.



Smithco may require the return of failed parts or components in order to determine the validity of any warranty claim.



Smithco will not be obligated to replace components of other manufacturers if inspection by the original component manufacturer indicates that failure was due to normal wear and tear, expected consumption through use or improper care or service.

Other Legal Disclaimers:

The above remedy for product defects through repair or replacement by an authorized Smithco distributor or dealer is the purchaser’s sole remedy for any defect. This warranty gives you specific legal rights, and you may also have other rights which vary from state to state.

THERE ARE NO OTHER EXPRESS WARRANTIES OTHER THAN THOSE SET FORTH ABOVE. ALL IMPLIED WARRANTIES OF MERCHANTABILITY AND FITNESS FOR USE ARE LIMITED TO THE DURATION OF THE LIMITED WARRANTIES CONTAINED HEREIN.

Some states may not allow limitations on how long an implied warranty lasts, so the above limitation may not apply to you.

THE SMITHCO COMPANY IS NOT LIABLE FOR INDIRECT, INCIDENTAL OR CONSEQUENTIAL DAMAGES IN CONNECTION WITH THE USE OF THE PRODUCT, INCLUDING ANY COST OR EXPENSE OF PROVIDING A SUBSTITUTE PRODUCT OR SERVICE DURING PERIODS OF MALFUNCTION OR NON-USE.

Some states may not allow the exclusion of indirect, incidental or consequential damages, so the above exclusion may not apply to you.

Smithco neither assumes, nor authorizes any person to assume for it, any other liability in connection with the sale or use of this product.

