

DYNAJET® FLEX 7140

INSTALLATION, SETUP AND USER GUIDE

Software Version 1.03
with optional Dual Nozzle Mode

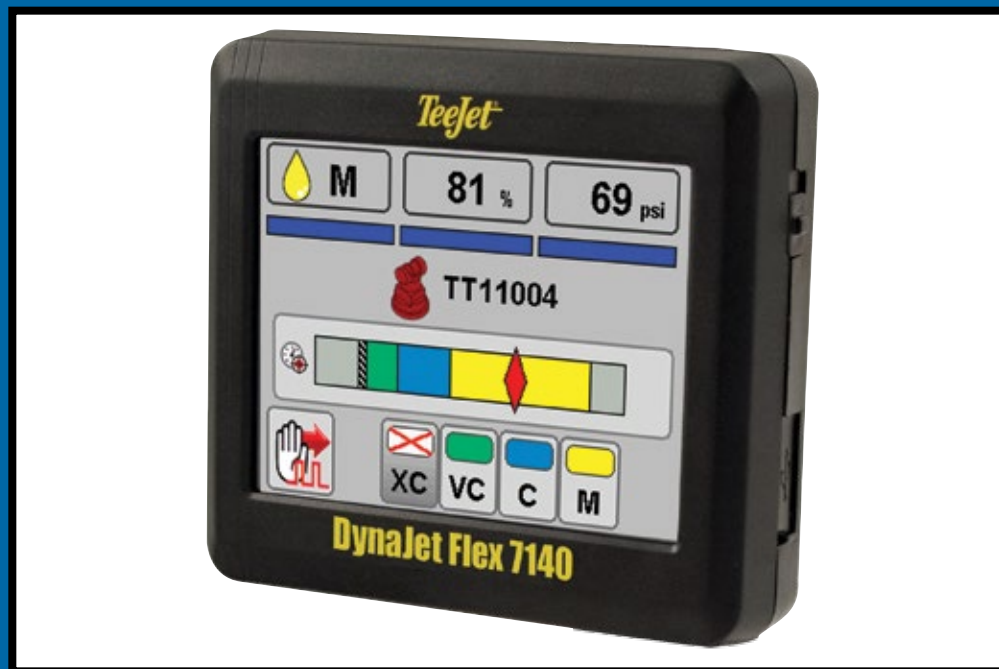

TeeJet[®]
TECHNOLOGIES

A Subsidiary of  Spraying Systems Co.[®]

Table of Contents

DYNAJET® FLEX OVERVIEW	1
INSTALLATION	1
CONSOLE	1
INSTALLATION	2
DynaJet Flex® Drivers	2
Power	2
Nozzle Harnesses	2
CAN Cables & Terminators	2
DynaJet Flex® Interface	2
Boom Interface Module (BIM) (optional)	2
Pressure Sensor Interface(optional).....	2
INITIAL STARTUP	5
Favorites	5
Setup	5
Units	6
Number of Sections	6
Number of Nozzles	6
Maximum Pressure Sensor Value	6
Nozzle Selection.....	7
<i>Select Nozzle Series</i>	7
<i>Select Nozzle Capacity</i>	7
Ready to Pressure Test the System	7
OPERATIONS	8
Work Screen.....	8
On Screen Indicators	8
<i>Droplet Size Chart</i>	8
Diagnostics	9
Error Warnings	10
USER SETTINGS	12
DYNAJET FLEX® NOZZLE SELECTION	14
Nozzle Selection Example	15
TUNING DYNAJET FLEX®	16
Tuning the Control Console Valve	16
Tuning the DynaJet Flex System	16
55295 E-CHEMSAVER® MAINTENANCE INSTRUCTIONS	17
General Disassembly and Reassembly.....	17
APPLICATION RATES AT GIVEN SPEED AND NOZZLE CAPACITY	18
SPEED RANGE AVAILABLE AT GIVEN N NOZZLE SIZE AND APPLICATION RATE	20

DYNAJET® FLEX OVERVIEW

The DynaJet Flex controller works in conjunction with an existing rate controller that regulates flow via a control valve or pump regulation to achieve a target application rate while maintaining target droplet size(s) when a speed change occurs. This system only works with automatic rate controllers that use flow based monitoring systems and not pressure based monitoring systems. Automatic rate controllers equipped for both flow and pressure based control should have the pressure-based system disabled to work in conjunction with DynaJet Flex.

The independent automatic rate controller loop performs the same as it would if the DynaJet Flex controller were not present. The DynaJet Flex controller changes flow output to each individual nozzle based upon input provided from the operator about the optimum droplet size (pressure) for the application.

INSTALLATION

CONSOLE

The DynaJet Flex console is designed to provide years of service under typical agricultural and turf operating conditions. A tight fitting enclosure means that typical dusty environments will not cause operational problems. While occasional splashing of water will not damage the unit, the DynaJet Flex console is not designed for direct exposure to rain. Take care not to operate the DynaJet Flex console in wet conditions.

Figure 1: DynaJet Flex 7140 Console Front and Back



Safety Information

TeeJet Technologies is not responsible for damage or physical harm caused by failure to adhere to the following safety requirements.

As the operator of the vehicle, you are responsible for its safe operation.

The DynaJet Flex is not designed to replace the vehicle's operator.

Be sure that the area around the vehicle is clear of people and obstacles before and during engagement.

The DynaJet Flex is designed to support and improve efficiency while working in the field. The driver has full responsibility for the quality and work related results.

INSTALLATION

DynaJet Flex® Drivers

There will be one DynaJet Flex Driver 78-05124 per eight (8) nozzles.

- Mount each DynaJet Flex Driver centered within the eight (8) nozzles it controls.

Power

Power will be sourced from the battery using the 60 amp fused cable 45-05943.

Power from the battery will be routed to the boom using the 6 gauge power cables 45-05942-xx

The Power Distribution Modules 78-05121-xx will connect to the 45-05942-xx cables.

Power will then route from 78-05121-xx to each DynaJet Flex Driver 78-05122 using cables 45-05971-xx, and 45-05997-xx or 45-05998-xx.

Nozzle Harnesses

When installing Nozzle Harnesses 45-04005-xx-xx always start with Section 1 and continue to the last section.

Nozzle Harnesses are designed for your specific nozzle spacing.

Always start with nozzle #1 and work left to right (while facing in the machine's forward direction).

CAN Cables & Terminators

The Start Terminator 45-04006-START must be connected to the DynaJet Flex Driver 78-05124 for Section 1.

CAN cables must be connected in series.

The End Terminator 45-04006-END must be connected to the Driver Module 78-05124 for the last section.

DynaJet Flex® Interface

The DynaJet Flex Interface 78-05123 connects to the DynaJet Flex Interface Harness 45-10193:

The DynaJet Flex Interface Harness connects to

- a. The Console 75-30119 (extension cable may be used)
- b. Power 12V for powering the CAN
- c. CAN
- d. Pressure Sensor
- e. Boom Sense

The DynaJet Flex Interface can be mounted in the cab or outside depending upon your installation.

Boom Interface Module (BIM) (optional)

The Boom Interface Module (BIM) 78-05091 is used by the DynaJet Flex System for boom sense.

The BIM Harness connects between the BIM and the CAN.

On the BIM Harness 45-10195, the Boom Sense Wires (or flying leads) are supplied to tie into existing machine boom section 12V ON/OV OFF outputs.

If not using 45-10195, some machine specific harnesses are available.

The BIM can be mounted in the cab or outside depending upon your installation.

Pressure Sensor Interface(optional)

Pressure Sensor Interface 78-05133 can be used if the DynaJet Flex Interface is mounted in the cab and there is a substantial distance to the boom.

- The Pressure Sensor Interface should be mounted close to the boom manifold.

Figure 2: Installation Diagram

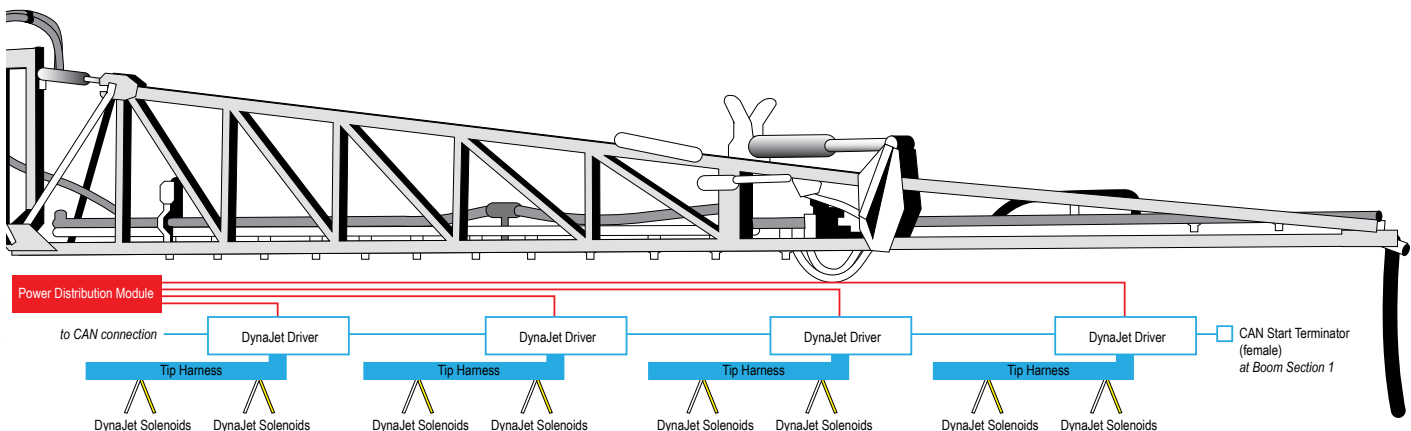
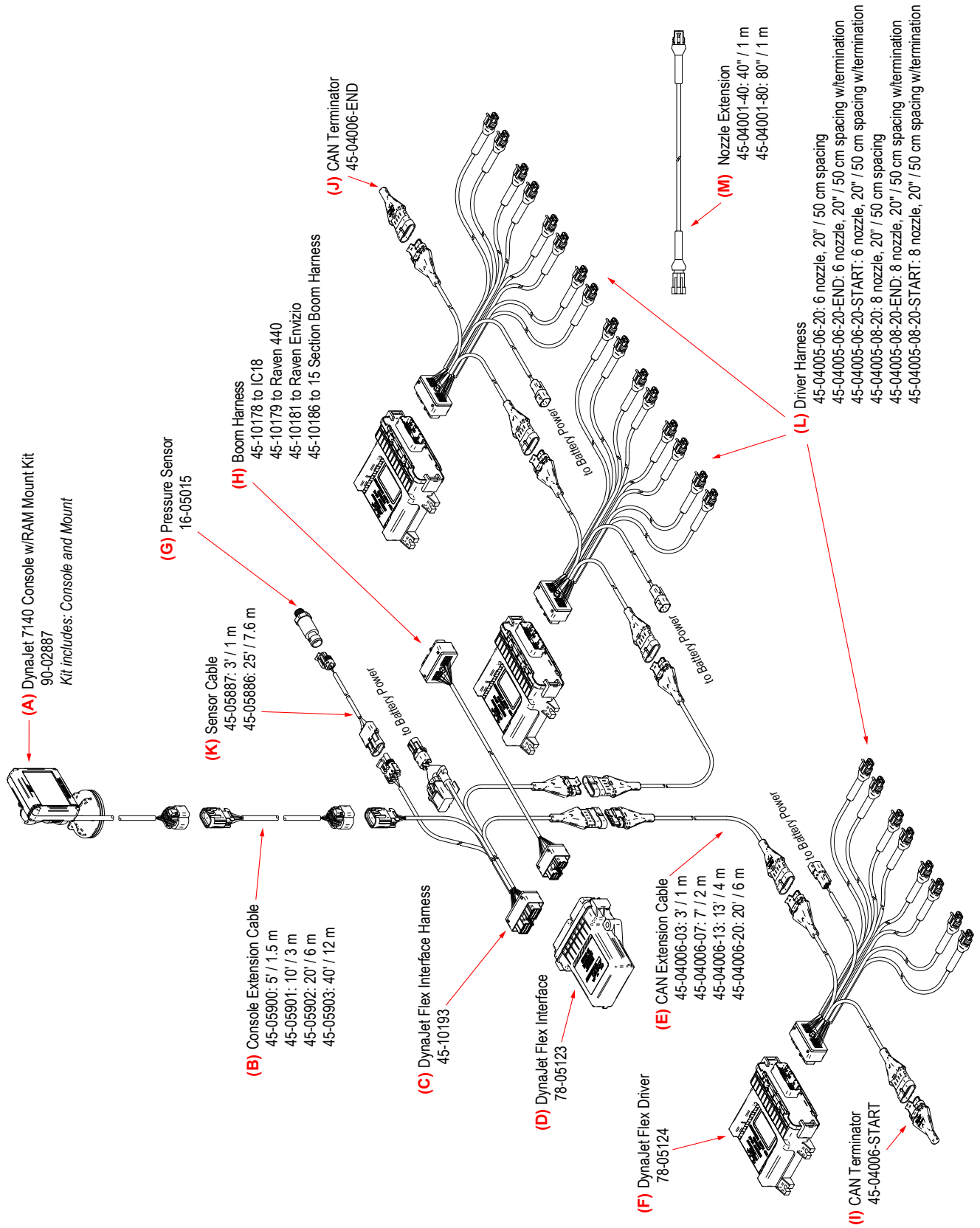
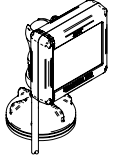
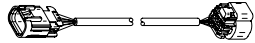
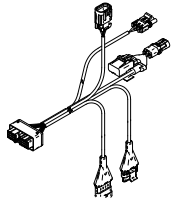
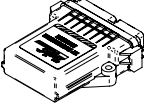
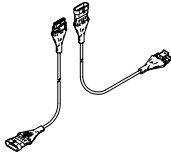
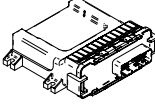



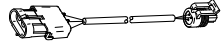
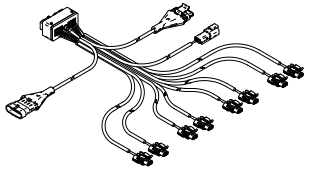



Figure 3: System Diagram



DynaJet® Flex 7140

Item	Part #	Description	Illustration
A	90-02887	DynaJet Flex 7140 Console	
B	45-05900: 5' / 1.5 m 45-05901: 10' / 3 m 45-05902: 20' / 6 m 45-05903: 40' / 12 m	Console Extension Cable	
C	45-10193	DynaJet Flex Interface Harness	
D	78-05123	DynaJet Flex Interface	
E	45-04006-03: 3' / 1 m 45-04006-07: 7' / 2 m 45-04006-13: 13' / 4 m 45-04006-20: 20' / 6 m	CAN Extension Cable	
F	78-05124	DynaJet Flex Driver	
G	16-05015	Pressure Sensor	
H	45-10178 to IC18 45-10179 to Raven 440 45-10181 to Raven Envizio 45-10186 to 15 Section Boom Harness	Boom Harness	
I	45-05855	CAN Terminator-START	
J	45-05856	CAN Terminator-END	
K	45-05887: 3' / 1 m 45-05886: 25' / 7.6 m	Pressure Sensor Cable	
L	45-04005-06-20: 6 nozzle, 20" / 50 cm spacing 45-04005-06-20-END: 6 nozzle, 20" / 50 cm spacing w/termination 45-04005-06-20-START: 6 nozzle, 20" / 50 cm spacing w/termination 45-04005-08-20: 8 nozzle, 20" / 50 cm spacing 45-04005-08-20-END: 8 nozzle, 20" / 50 cm spacing w/termination 45-04005-08-20-START: 8 nozzle, 20" / 50 cm spacing w/termination	Driver Harness	
M	45-04001-40: 40" / 1 m 45-04001-80: 80" / 2 m	Nozzle Extension	

INITIAL STARTUP

This section will explain basic setup of the values required for first-time setup of a DynaJet Flex system. When these settings are completed, initial operation and fine-tuning should be possible.

To access setup menu from the work screen, touch center of the screen.

1. Select from:

- ▶ Favorites – The FAVORITE icon ★ represents favorite spray nozzles. This function automatically stores the most recent five (5) nozzles chosen. Use this to quickly access your most frequently used spray nozzles.
- ▶ Setup – The SETUP icon ⚙️ is used to access settings. This will enter the configuration menu.
- ▶ Nozzle Selection – The SPRAY NOZZLE icon 🍷 is used to select the spray nozzle style and capacity. Once chosen here, the spray nozzle style and capacity is automatically added to the favorites list.
- ▶ Diagnostics – The DIAGNOSTICS icon 📋 is used to diagnose and operating issues of the system and booms. The Diagnostics menu is described in the Operations Chapter.

2. Press HOME icon 🏠 to return to the main work screen.

Figure 4: Options Menu

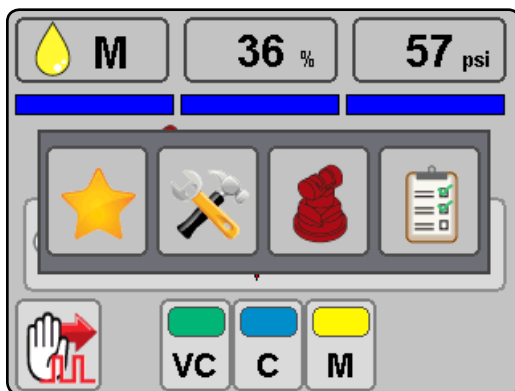

Favorites

- ★ The favorite icon represents favorite spray nozzles. This function automatically stores the most recent five (5) nozzles chosen. Use this to quickly access your most frequently used spray nozzles.

Figure 5: Favorites

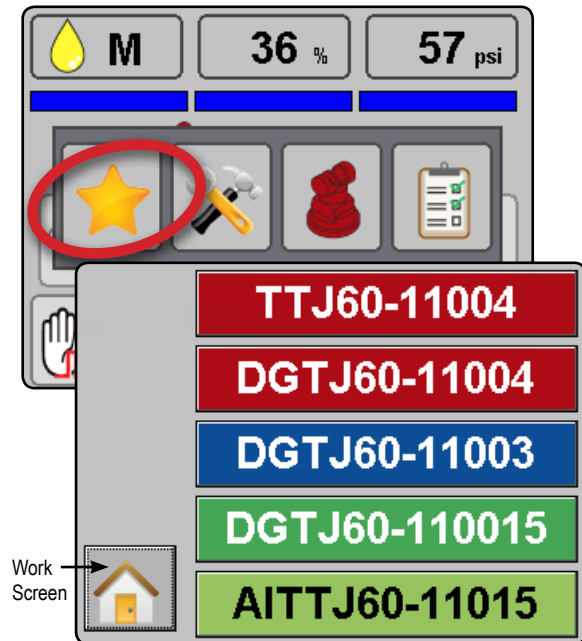

Setup

- ⚙️ The setup icon is used to access settings. This will enter the configuration menu. Selections are automatically saved when adjusted.

NOTE: Not all settings are listed below. See “User Settings” section of this guide for additional settings and details.

Figure 6: Setup

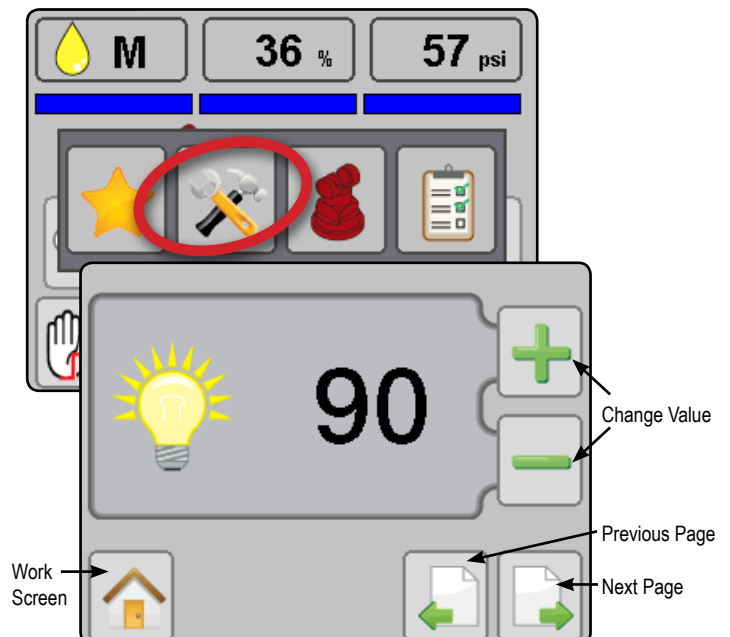

Units

Sets the units to US (psi) or Metric (bar).

Figure 7: Units



Number of Sections

Set the number of boom sections. This should match the number of sections used on the spray controller. Range is 1 to 15.

Figure 8: Number of Sections

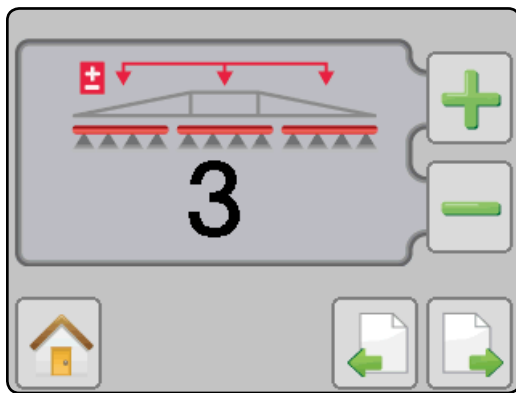

Number of Nozzles

Set the number of nozzles for each section. This value should match the number of nozzles used on the spray controller. When programming is complete, values should match and show in green. Range is 1 to 120.

- ▶ Green matching values indicate a match between the number of nozzles detected and the number of nozzles programmed.
- ▶ Red mismatching values indicate a mismatch between the number of nozzles detected and the number of nozzles programmed.

NOTE: Mismatched values will stop screen advancement until number of nozzles detected and number of nozzles programmed match.

Figure 9: Number of Nozzles – Match

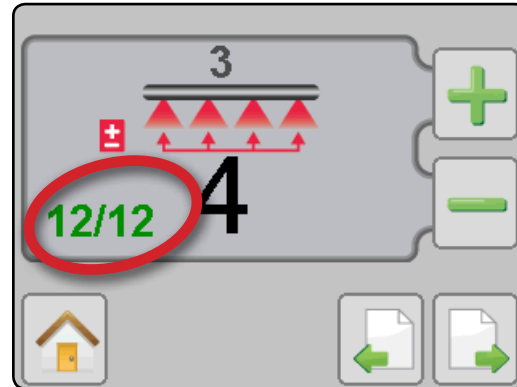
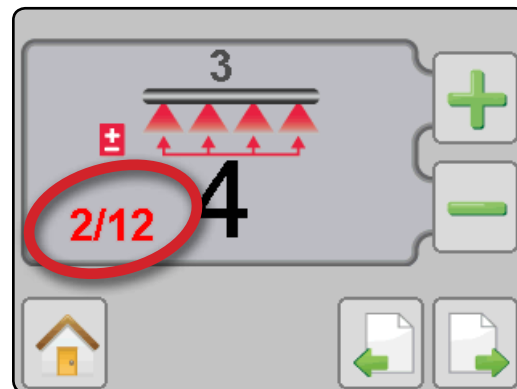

Figure 10: Number of Nozzles – Mismatch



Maximum Pressure Sensor Value

Verify this value by looking at the pressure sensor description. Values will be either 10 bar (145 psi) or 25 bar (363 psi).

If pressure value displayed on the DynaJet Flex console are not accurate compared to a mechanical gauge, adjust this value until there is a match.

- ▶ Increasing the value will reduce the pressure value displayed during operation
- ▶ Decreasing this value will increase the pressure value displayed during operation

Figure 11: Max Pressure Sensor Value



Nozzle Selection

 Accesses the nozzle selection process to select which nozzle is to be used. At this time only TeeJet nozzles are supported.

Figure 12: Nozzle Selection



Select Nozzle Series

Use the green up and down arrows to highlight the correct spray nozzle series/family.

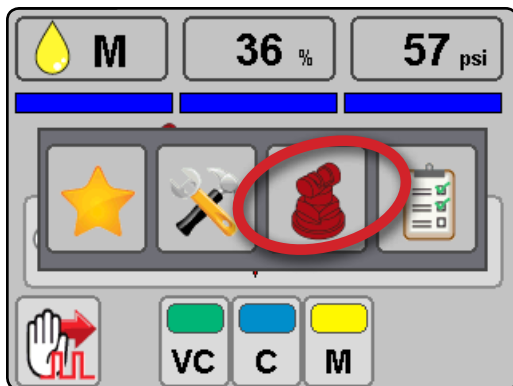
Figure 13: Select Nozzle Series



Select Nozzle Capacity

With the correct nozzle capacity highlighted, select the HOME icon  to return to operating mode. The selected nozzle will be active and will automatically be added to the favorites list.

Figure 14: Select Nozzle Capacity



Ready to Pressure Test the System

1. Ensure that current rate control system is operating at the optimum level. Set DynaJet Flex operating mode to manual and set PWM duty cycle at 100%. This will make the system operate as if DynaJet Flex was not present. Use this configuration to verify the rate control system is operating normally.
2. Keep DynaJet Flex operating mode on manual and change PWM duty cycle to 50%. Use this configuration to verify the rate control system is operating normally.
3. Confirm boom section functionality by observing the row of rectangles below the on the operating display. Switch the master switch ON (on rate control or other boom section control switches) and individual sections one at a time. Make sure each section appropriately changes color to blue. With the master switch OFF, all active sections will be gray again.
4. Start pump and ensure no leaks.
5. Verify pressure on mechanical gauge matches the digital pressure display within reason. If not, adjust max pressure sensor value as previously described.
6. Configure in PWM mode DynaJet Flex at duty cycle of 50%. Confirm each e-ChemSaver (ECS) is pulsating.

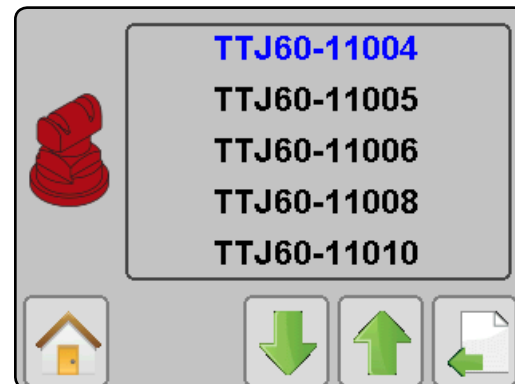
At this point the system is functioning. Further details for fine-tuning the system are available in the User Settings section of this guide.

OPERATIONS

Prior to operation, all settings and configurations must be established. Please contact a dealer or TeeJet Customer service representative with questions about system operations. TeeJet Technologies is not responsible for misuse or incorrect operation of the system. Settings are automatically saved when selected. Select functions may not be visible due to OEM settings, available equipment or sensors.

Work Screen

On Screen Indicators

Current Droplet Size – Displays the current droplet size using both the appropriate color droplet icon and size letter code.

PWM Duty Cycle – Displays the current PWM duty cycle as a percentage.

Active Solenoid (Dual Nozzle Mode only) – Displays if one or both sets of solenoids are active.

Actual Pressure – Displays the actual pressure.

Boom Status

- ▶ Blue – turned on (Single Nozzle Mode or Dual Nozzle Mode single solenoid active)
- ▶ Green – turned on (Dual Nozzle Mode both solenoids active)
- ▶ Empty – turned off

Current Nozzle Selection – Displays the current selected nozzle.

Pressure Gauge

- ▶ Red Diamond – actual pressure
- ▶ Colors – droplet size

Operation Modes

- ▶ Dual Nozzle Mode – user can operate in Nozzle Mode or Manual Mode with the option to choose between the use of single solenoid or dual solenoid.

 **Nozzle Mode (Pressure)** – when the user changes the desired drop sizes choices (via the droplet size selectors checkboxes) the system will recalculate the desired pressure. It will then adjust the PWM duty cycle to attempt to attain the desired pressure in the system.

 **Manual Mode (PWM)** – The user can manually adjust the PWM duty cycle to attempt to attain the desired pressure in the system.

 **Single Solenoid** – one set of solenoids active

 **Dual Solenoid** – both sets of solenoids active

- ▶ **Single Nozzle Mode** – user can operate in Nozzle Mode or Manual Mode.

 **Nozzle Mode (Pressure)** – When the user changes the desired drop sizes choices (via the droplet size selectors checkboxes) the system will recalculate the desired pressure. It will then adjust the PWM duty cycle to attempt to attain the desired pressure in the system.

 **Manual Mode (PWM)** – The user can manually adjust the PWM duty cycle to attempt to attain the desired pressure in the system.

Droplet Size Selectors

- ▶  **Red X and grayed out** – Not selected

Droplet Size Chart

When choosing a spray nozzle that produces droplet sizes in one of the eight droplet size classification categories, it is important to remember that a single nozzle can produce different droplet size classifications at different pressures. A nozzle might produce medium droplets at low pressures, while producing fine droplets as pressure is increased.

Category	Symbol	Color Code
Extremely Fine	XF	Violet
Very Fine	VF	Red
Fine	F	Orange
Medium	M	Yellow
Coarse	C	Blue
Very Coarse	VC	Green
Extremely Coarse	XC	White
Ultra Coarse	UC	Black

Work Screen – Dual Nozzle Mode

Figure 15: Nozzle Mode

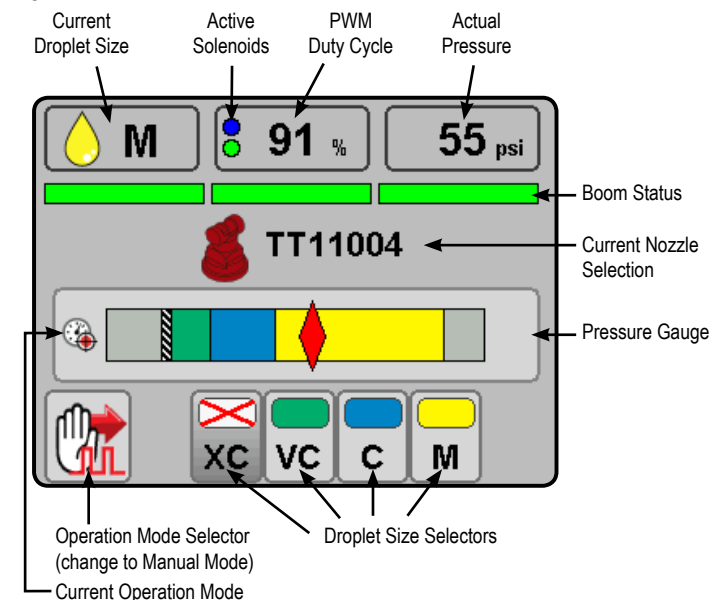

Figure 16: Manual Mode, Single Solenoid

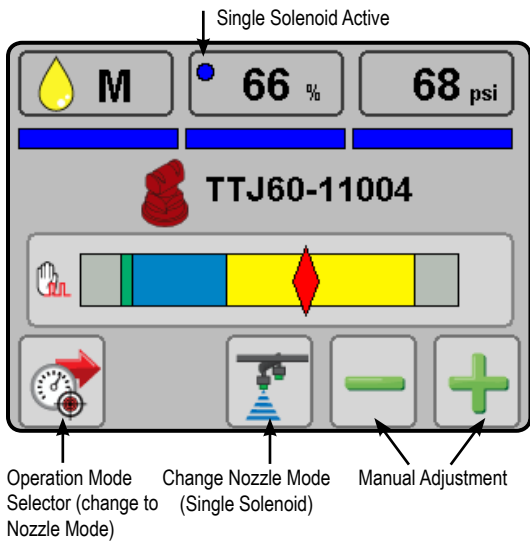
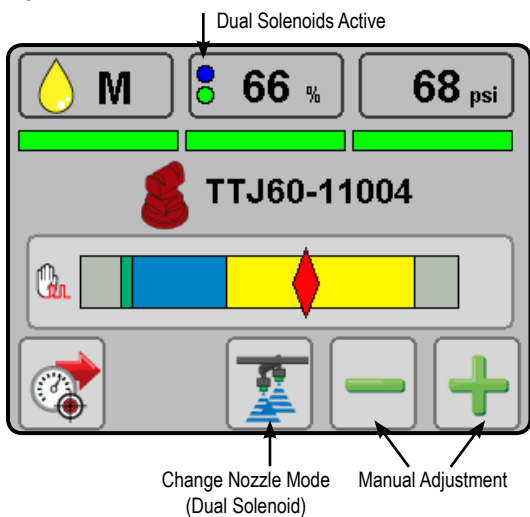

Figure 17: Manual Mode, Dual Solenoid



Work Screen – Single Nozzle Mode

Figure 18: Nozzle Mode

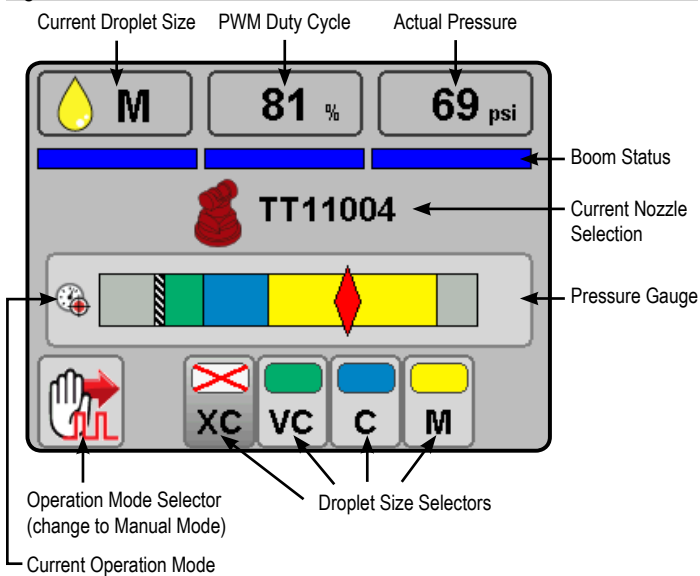
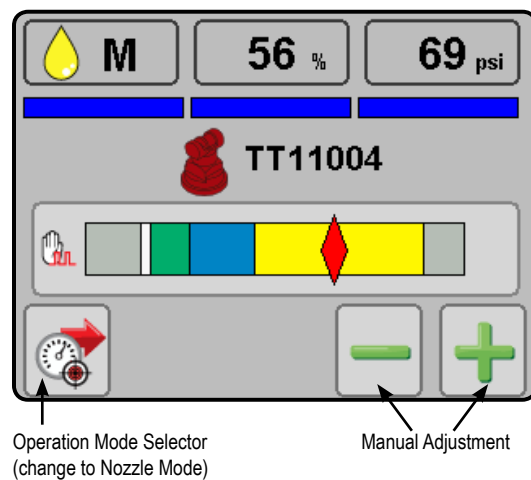

Figure 19: Manual Mode



Diagnostics

The DIAGNOSTICS icon accesses diagnostic information. This will display a system overview and indicate if system components are operating properly.

Figure 20: Diagnostics

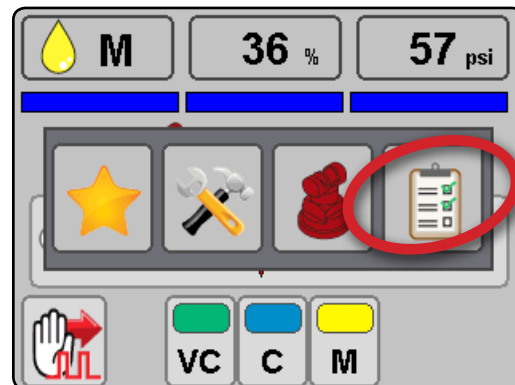

Navigating Diagnostic Pages

Use the next page and previous page icons to navigate between drivers. To navigate between nozzles on the selected driver, use the Next Nozzle button.

System Overview

- ▶ Page Navigation – indicates current page/total pages
- ▶ Console Version – displays the current software version
- ▶ Pressure Sensor – displays pressure sensor status
- ▶ Boom Interface – symbol indicating the boom interface
- ▶ DynaJet Flex Interface – indicates the interface version and type
- ▶ Start Terminator – displays status of the start terminator
- ▶ End Terminator – displays status of the end terminator
- ▶ Drivers – displays the number of drivers detected
- ▶ Nozzles – displays the number of nozzles detected
- ▶ Current Errors – tracks the number of current errors
- ▶ Ignored Errors – tracks the number of ignored errors
- ▶ Refresh Error Log – clears out tallied current and ignored errors

Figure 21: System Overview

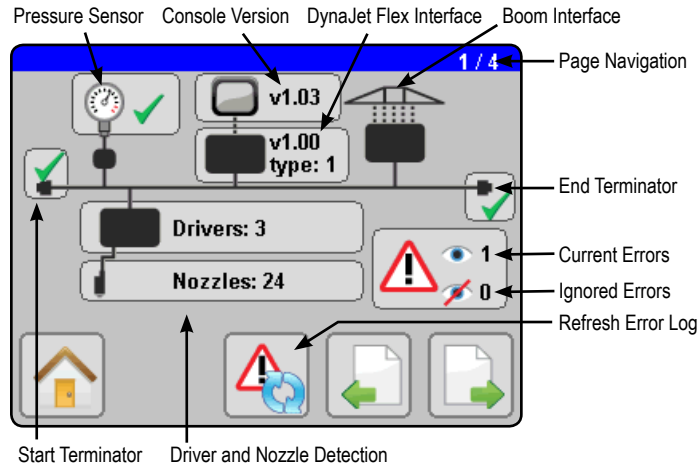

Driver and Nozzle Overview

- ▶ **Driver Information** – displays the numeric position of the driver, current voltage, software version, and type. Drivers are numbered from left to right while facing in the machine's forward direction.
- ▶ **Nozzle Information**
 - Nozzles are designated two ways:
 - ▶ **Nozzle Number** – numbered from left to right while facing in the machine's forward direction.
 - ▶ **Nozzle Location** – numbered from left to right while facing in the machine's forward direction by driver number and nozzle number including an A or B distinction for the solenoid position.
 - ▶ **Next Nozzle** – navigates through nozzle information

Figure 22: Driver and Nozzle Overview – Dual Nozzle Mode

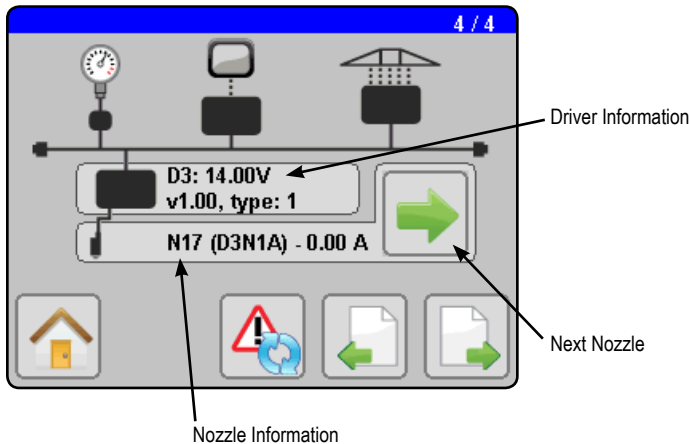
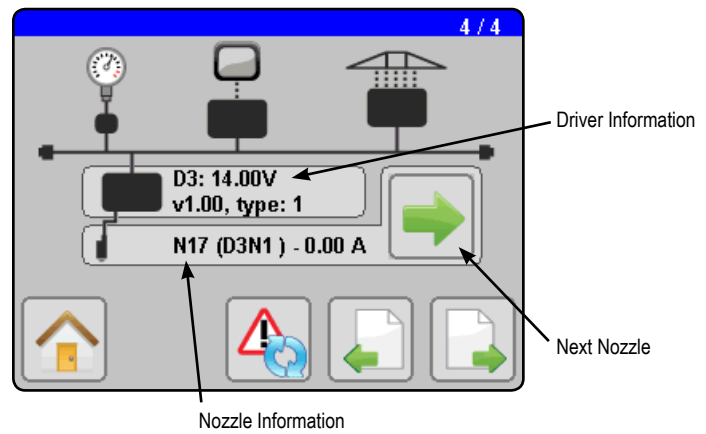

Figure 23: Driver and Nozzle Overview – Single Nozzle Mode



Error Warnings

If there is an active error, a warning screen will appear indicating the offending system component in red with an Error Warning icon.

- Refresh Error Log – press this button to clear the error log
- Next Error – press this button to view the next error when multiple errors occur
- Ignore Error – press this button to disregard an error.

Figure 24: Error Warning Navigation

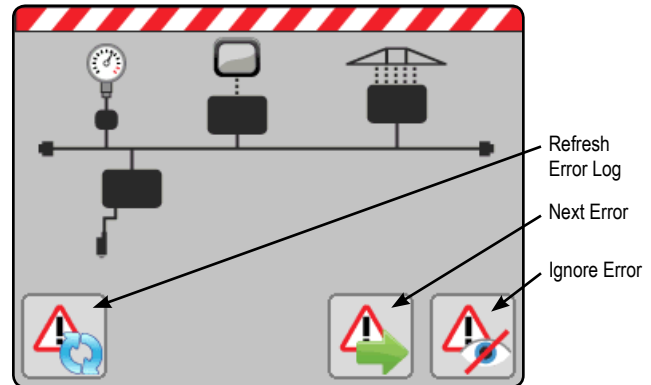

Terminator Errors

Terminator Errors indicate that the specified terminator is not detected.

Figure 25: Terminator Error

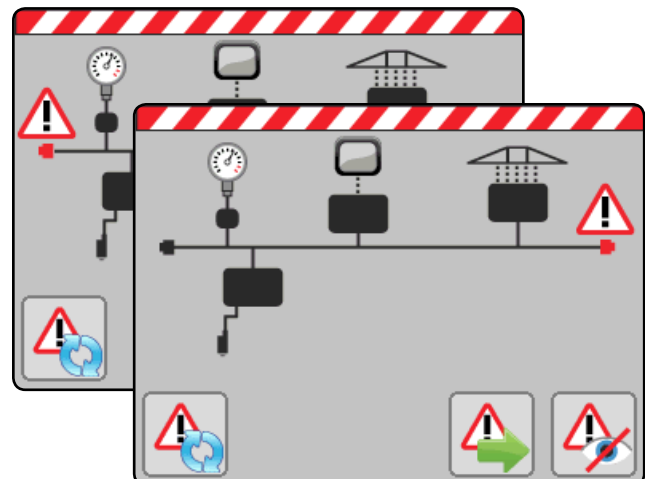

Driver Module Error

Driver Module Errors indicate that the specified driver is not detected.

Figure 26: Driver Module Error

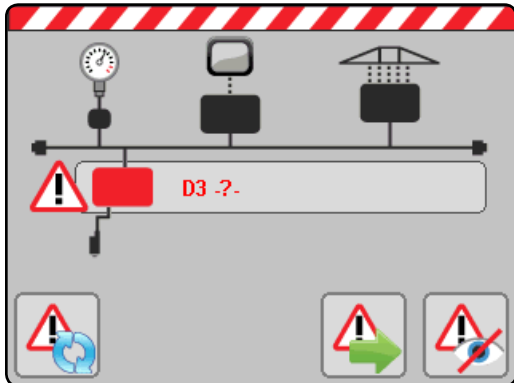

Nozzle Sensor Error

Nozzle Sensor Errors indicate which nozzle is in error by displaying the nozzle number, nozzle location and current Amps.

Figure 27: Nozzle Sensor Error

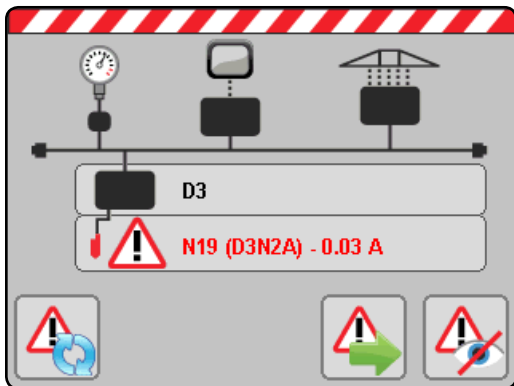

Pressure Sensor Error

Indicates when a pressure sensor is not detected.

Figure 28: Pressure Sensor Error

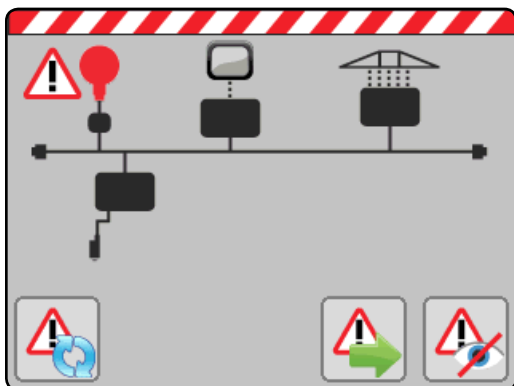

Pressure Sensor Interface

Systems equipped with a Pressure Sensor Interface will indicate whether Interface has lost contact with the CAN.

Figure 29: Pressure Sensor Interface Error

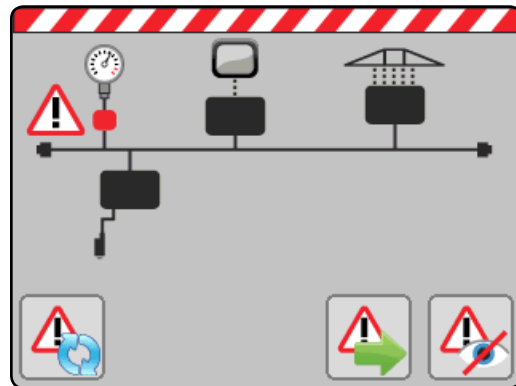

Nozzle Mode Errors

- ▶ Minimum Duty Cycle Error – the desired pressure is not being maintained by the system.
- ▶ High Pressure Error – the actual pressure is above the High Pressure alarm value.
- ▶ Outside Droplet Size Error – droplet size is not being maintained by the system.

Figure 30: Nozzle Mode – Minimum Duty Cycle Error

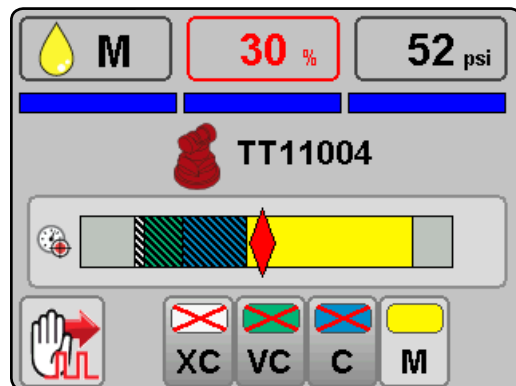

Figure 31: Nozzle Mode – High Pressure Error

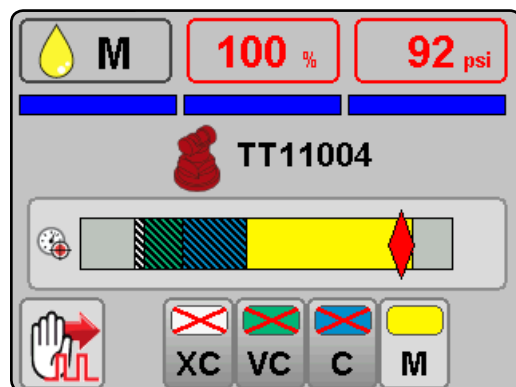
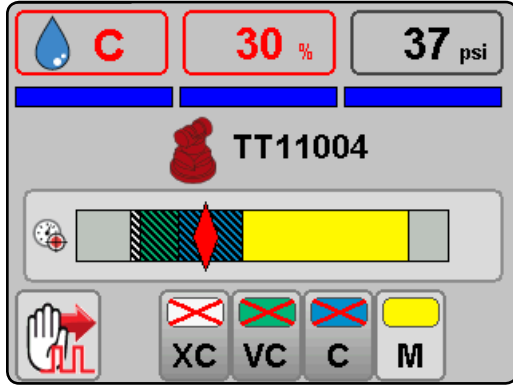

Figure 32: Nozzle Mode – Outside Droplet Size Error



Manual Mode Errors

- ▶ High Pressure Error – the actual pressure is above the High Pressure alarm value.
- ▶ Low Pressure Error – the actual pressure is below the recommended nozzle pressure range.

Figure 33: Manual Mode – High Pressure Error

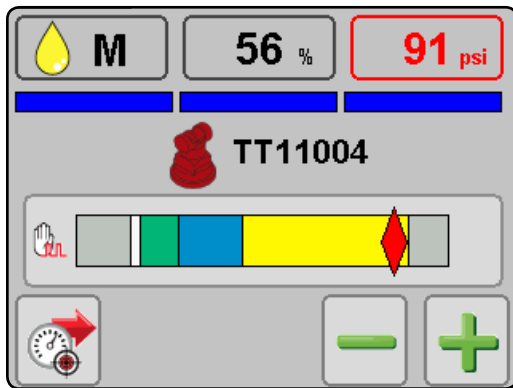
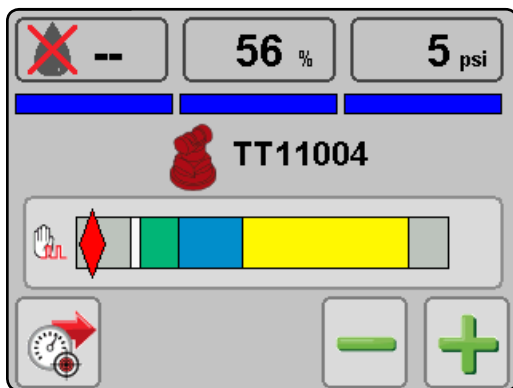



Figure 34: Manual Mode – Low Pressure Error



USER SETTINGS

 If there are questions concerning the setup of the DynaJet Flex, please contact your dealer or TeeJet Customer service representative for clarification before operation. TeeJet Technologies is not responsible for misuse or incorrect operation of the system.

Setup is used to configure Units, Display Brightness, Key Beep, Number of Sections, Boom Section On/Off Beep, Maximum Pressure Sensor Value, Minimum Duty Cycle, Control Hold Delay, Fine Gain, Coarse Gain, and Coarse Gain On/Off.

Display Brightness

Sets the brightness level of the display. Range is 5% to 100% in 5% increments.



Units

Sets the units to US (psi) or Metric (bar).



Key Beep

Enable/disable all beeping from console.

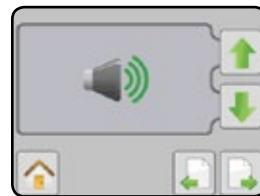

Number of Sections

Set the number of boom sections. Range is 1 to 15.



Number of Nozzles (Per Section)

Set the number of nozzle locations for each boom section. Range is 1 to 120.

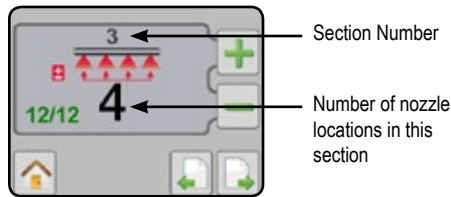

Boom Section On/Off Beep

Enable/disable beep when a boom section is turned on or off.



Pressure Sensor Max

Sets the value from the pressure sensor description. Either 10 bar (145 psi) or 25 bar (363 psi).



Minimum Duty Cycle

Sets the minimum duty cycle to which the DynaJet Flex will control. Default is 30%, minimum is 20%.

Higher values reduce the overall control range of the system.



Control Hold Delay

When any boom switch changes state, DynaJet Flex will not make control adjustments for the specified time period. Range is 0.0 to 10.0 seconds. Default is 1.0 second.

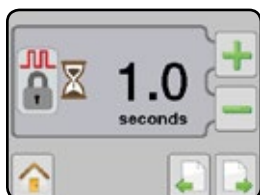

Coarse Gain

This is the more aggressive gain setting and will have the largest impact on the stability and function of the DynaJet Flex system. Coarse gain makes major adjustments to duty cycle to attempt to bring actual pressure back to the target. A Coarse Gain setting that is too high will result in pressure oscillation. Range is 1 to 20. Default is 4.



Fine Gain

Allows the control system to make minor adjustments when close to the target, with the goal of stable pressures and minimal overshoot of target. Range is 1 to 20. Default is 6.



DYNAJET FLEX® NOZZLE SELECTION

Selection of the proper spray nozzle for use with the DynaJet Flex system is much like selecting the spray nozzle for a traditional spraying operation. Along with the extra application flexibility, DynaJet Flex brings a few other nozzle-related considerations that will be summarized below.

1. Duty Cycle

- a. DynaJet Flex controls nozzle flow rate by varying the portion of time that each nozzle is 'on' vs. 'off'. The on time is referred to as Duty Cycle. The range of duty cycle available is typically 30% to 100%, meaning that the nozzles on the machine will have the approximately 30% to 100% of their rated flow capacity.
- b. With the DynaJet Flex System:
 - Standard Mode $\text{Spray Nozzle Flow Capacity} = \text{Spray Nozzle Size} \times \text{Duty Cycle}$
 - Dual Nozzle Mode $\text{Spray Nozzle Flow Capacity} = \text{Spray Nozzle Size} \times \text{Duty Cycle} \times 2$
- c. By varying the duty cycle, the DynaJet Flex is essentially varying spray nozzle capacity on the fly. When more pressure is required, the nozzle capacity (duty cycle) is reduced. When higher nozzle capacity is required, the duty cycle is increased.
- d. Although the operator has a much more flexible and forgiving application system with DynaJet Flex, care should be taken to select spray nozzles that give the best possible results.
- e. When selecting a spray nozzle, review the DynaJet Flex nozzle selection charts and select a spray nozzle capacity that produces the target application rate at a duty cycle of about 70% when running at expected travel speeds. In other words, choose nozzle capacity and desired pressure/droplet size closer to the high end of the speed (or rate) range than to the lower end. This will provide plenty of adjustment range for DynaJet Flex to reduce duty cycle when travel speed slows, while also providing additional capacity if travel speed increases above the planned speed.
 - The default setting for minimum duty cycle is 30%. This means the system will not adjust the duty cycle below 30% 'on'. While this setting can be set as low as 20% by the operator, the higher default value provides a more uniform application at lower speeds.

2. Spray Nozzle Selection

- a. The DynaJet Flex system is not compatible with all spray nozzles. Approved nozzle families are XR TeeJet, DG TeeJet, Turbo TwinJet, Turbo TeeJet, and Air Induction Turbo TwinJet 60.
- b. Different nozzle styles have different droplet size characteristics across the range of operating pressures. The spray nozzle style should be selected based on the desired droplet size at the pressures expected to be in use for your application.
- c. Always use spray nozzles with 110° (or wider) spray pattern. These spray nozzle part numbers will typically include the 110 in their name – for example TT11006VP or XR11006-VS. 80° spray nozzles are not recommended with DynaJet Flex.

3. Spray Height

- a. In order to achieve the best possible spray coverage, make sure to keep spray height at or above 20" from the nozzle to the target.

Nozzle Selection Example

These columns show flow rates at various pressures. The Delta P represents pressure loss through the DynaJet Flex solenoid valve, and the resulting Nozzle PSI and Flow show actual values at the spray nozzle.

These columns show droplet sizes for different styles of spray nozzle at given pressures. Use these columns to choose the best nozzle style for your application.

Just like a normal nozzle chart, these columns show rates available at given speeds. The only difference is the range of values that corresponds to the range of flows available with DynaJet Flex.

Tip No.	Gauge Pressure PSI	Rated GPM	Δ P	Tip		Min Duty Cycle 30%		Tip Spacing 20 inches			
						TT	TTJ60	6 mph	8 mph	10 mph	12 mph
				PSI	Flow			GPA	GPA	GPA	GPA
11006 TT TJ60 TTJ60 XR XRC (50)	20	0.42	3	17	0.39	XC	-	5.8 to 19.3	4.3 to 14.5	3.5 to 11.6	2.9 to 9.7
	30	0.52	4	26	0.48	VC	VC	7.1 to 24	5.3 to 17.8	4.3 to 14.3	3.6 to 11.9
	40	0.60	5	35	0.56	VC	C	8.3 to 28	6.2 to 21	5.0 to 16.6	4.2 to 13.9
	50	0.67	6	44	0.63	VC	C	9.4 to 31	7.0 to 23	5.6 to 18.7	4.7 to 15.6
	60	0.73	7	53	0.69	C	C	10.2 to 34	7.7 to 26	6.1 to 20	5.1 to 17.1
	70	0.79	8	62	0.74	C	C	11.0 to 37	8.2 to 27	6.6 to 22	5.5 to 18.3
	80	0.85	9	71	0.80	C	C	11.9 to 40	8.9 to 30	7.1 to 24	5.9 to 19.8
	90	0.90	10	80	0.85	M	C	12.6 to 42	9.5 to 32	7.6 to 25	6.3 to 21

If the operator wants to apply 15 GPA at 10 MPH, he would look in the 10 MPH column, and find the row that shows 15 GPA with room above and below to compensate for higher and lower speeds that may be experienced in the field. In this case a TT11006 at 40-50 PSI will work very well.

Tip No.	Gauge Pressure PSI	Rated GPM	Δ P	Tip		Min Duty Cycle 30%		Tip Spacing 20 inches			
						TT	TTJ60	6 mph	8 mph	10 mph	12 mph
				PSI	Flow			GPA	GPA	GPA	GPA
11006 TT TJ60 TTJ60 XR XRC (50)	20	0.42	3	17	0.39	XC	-	5.8 to 19.3	4.3 to 14.5	3.5 to 11.6	2.9 to 9.7
	30	0.52	4	26	0.48	VC	VC	7.1 to 24	5.3 to 17.8	4.3 to 14.3	3.6 to 11.9
	40	0.60	5	35	0.56	VC	C	8.3 to 28	6.2 to 21	5.0 to 16.6	4.2 to 13.9
	50	0.67	6	44	0.63	VC	C	9.4 to 31	7.0 to 23	5.6 to 18.7	4.7 to 15.6
	60	0.73	7	53	0.69	C	C	10.2 to 34	7.7 to 26	6.1 to 20	5.1 to 17.1
	70	0.79	8	62	0.74	C	C	11.0 to 37	8.2 to 27	6.6 to 22	5.5 to 18.3
	80	0.85	9	71	0.80	C	C	11.9 to 40	8.9 to 30	7.1 to 24	5.9 to 19.8
	90	0.90	10	80	0.85	M	C	12.6 to 42	9.5 to 32	7.6 to 25	6.3 to 21

The next consideration is droplet size. The chart shows that a Turbo TeeJet (TT) nozzle will give Very Coarse (VC) droplets in this pressure range, and a Turbo TwinJet (TTJ60) will give Coarse (C) droplets. The benefit of the TT is that the operator could select droplets from VC to M all at the same rate and speed.

Tip No.	Gauge Pressure PSI	Rated GPM	Δ P	Tip		Min Duty Cycle 30%		Tip Spacing 20 inches			
						TT	TTJ60	6 mph	8 mph	10 mph	12 mph
				PSI	Flow			GPA	GPA	GPA	GPA
11006 TT TJ60 TTJ60 XR XRC (50)	20	0.42	3	17	0.39	XC	-	5.8 to 19.3	4.3 to 14.5	3.5 to 11.6	2.9 to 9.7
	30	0.52	4	26	0.48	VC	VC	7.1 to 24	5.3 to 17.8	4.3 to 14.3	3.6 to 11.9
	40	0.60	5	35	0.56	VC	C	8.3 to 28	6.2 to 21	5.0 to 16.6	4.2 to 13.9
	50	0.67	6	44	0.63	VC	C	9.4 to 31	7.0 to 23	5.6 to 18.7	4.7 to 15.6
	60	0.73	7	53	0.69	C	C	10.2 to 34	7.7 to 26	6.1 to 20	5.1 to 17.1
	70	0.79	8	62	0.74	C	C	11.0 to 37	8.2 to 27	6.6 to 22	5.5 to 18.3
	80	0.85	9	71	0.80	C	C	11.9 to 40	8.9 to 30	7.1 to 24	5.9 to 19.8
	90	0.90	10	80	0.85	M	C	12.6 to 42	9.5 to 32	7.6 to 25	6.3 to 21

TUNING DYNAJET FLEX®

Tuning the Control Console Valve

The following procedure will help determine the rate controller valve gain that is the most aggressive value that will work over all pressure ranges with the DynaJet Flex in manual mode set to different duty cycles. The most aggressive value will be found by increasing the valve gains or other controller specific settings until system oscillates and then decrease those setting to make sure the system is stable at that value.

The tests will confirm that pulsing of flow through the solenoids doesn't affect rate controller stability even when duty cycle is below 50%.

Ensure product pump is providing flow greater than the maximum demand of the system.

Adjust target application rate or machine speed to deliver minimum and maximum operating pressures for the nozzle in use under the following conditions (rate control must be operating in automatic mode for these tests):

1. DynaJet Flex duty cycle set to 100%.
 - i. Set rate controller gains/values with operating pressure at minimum. Controller gain value at minimum pressure: _____
 - ii. Set rate controller gains/values with operating pressure at maximum. Controller gain value at maximum pressure: _____
2. DynaJet Flex duty cycle set to 50%.
 - i. Set rate controller gains/values with operating pressure at minimum. Controller gain value at minimum pressure: _____
 - ii. Set rate controller gains/values with operating pressure at maximum. Controller gain value at maximum pressure: _____
3. DynaJet Flex duty cycle set to "Minimum Duty Cycle" value (default is 30%)
 - i. Set rate controller gains/values with operating pressure at minimum. Controller gain value at minimum pressure: _____
 - ii. Set rate controller gains/values with operating pressure at maximum. Controller gain value at maximum pressure: _____
4. Set rate controller valve gain to the highest value that will work with all previous scenarios. This will be the lowest gain value found in the previous 6 tests. This value should not need to be changed again.
5. If the system does not control acceptably with this gain value at all manual duty cycle settings, then something is wrong with the system that needs to be resolved before trying to tune the DynaJet Flex System.

Tuning the DynaJet Flex System

The following steps will use Coarse Gain and Fine Gain to tune the DynaJet Flex System. Coarse Gain will be increased until the system is oscillating across the target pressure. Once that is occurring then Fine Gain will be increased to smooth/eliminate the oscillation. A Coarse Gain too low will cause the system to be stable but slow to get on target. A Coarse Gain too high will cause the system to overshoot target when a speed change happens. A Fine Gain too low will allow the system to continue to oscillate. A Fine Gain too high will cause the system to oscillate extremely rapidly and cause a thumping in the system. The lower the target pressure, the higher the Fine Gain can be set, so the tuning needs to be done at highest pressure/ smallest droplet size that the machine will typically be operating. Speed changes will be required for the best tuning possible. Simulated speed changes are preferred, but driving the machine is ok. Steady speeds are required.

1. Set console to Nozzle Mode and choose the nozzle being used.
2. Set Coarse Gain to 2 and Fine Gain to 2.
 - 2.1 Disable Jump Point by setting value to 0.
 - 2.2 Choose the highest pressure/smallest droplet size that will typically be used
 - 2.3 Run the system and view the PSI on the DynaJet Flex when changing speed. Increase the Coarse Gain until system is oscillating across target pressure. Most machines operate with a setting between 4-6 for Coarse Gain.
3. Once Coarse Gain is determined, then using the same speed changes as before begin increasing Fine Gain until the oscillations stop and the target rate and target pressure are stable. Most machines operate with a setting between 8-12 for Fine Gain.
4. After Coarse Gain and Fine Gain have been set, then select a lower pressure/larger droplet size and run the machine using the same speed changes. Typically, the settings will not have to be changed for the lower pressure applications.
5. If more than one nozzle size is going to be used on the machine, then run a test with the same values for Coarse Gain and Fine Gain for the other nozzles. Always check at the highest pressure/smallest droplet size that will typically be used.

55295 E-CHEMSAVER® MAINTENANCE INSTRUCTIONS

The 55295 e-ChemSaver is a solenoid-actuated shutoff compatible with a wide range of TeeJet nozzle bodies equipped with a diaphragm check valve. It can be used for end-of-boom nozzles as well as individual nozzle shutoff and PWM controls.

The valve is normally closed and opens when the solenoid is energized. The 55295 has a 2-Pin MetriPack connector molded into the body for a clean, weather-tight electrical connection.

General Disassembly and Reassembly

NOTE: O-rings (8, 9, 10) should be handled with care as they can be damaged/deformed

1. Loosen and remove the Nylon Nut (4) and Stainless Steel Washer (5)
2. Separate the Coil Assembly (1) from the rest of the Tube/Plunger Assembly (2, 3, 6-11)
3. Remove the Locking Ring (11)
4. Using pliers to grip the Stainless Steel Interface Cap (7), loosen the Tube Sub-Assembly (2) using a 9/16" (14 mm) or adjustable wrench. Note a low-profile 9/16" wrench is available from TeeJet using part number 97-00067.

All repairable parts should be accessible at this point. The Plunger Sub-Assembly (3), Stainless Steel Spring (6), and O-rings (8, 9, 10) can be replaced without further disassembly

5. During reassembly, place the Plunger Sub-Assembly (3) and Stainless Steel Spring (6) in the Tube Sub-Assembly (2)

NOTE: The Plunger Sub-Assembly (3) should be oriented with the black insert facing outward (visible) when placed in the Tube Sub-Assembly (2)

6. While compressing the Spring (6), thread the Tube/Plunger Assembly (2, 3, 6-11) to the Stainless Steel Interface Cap (7) and tighten using a wrench and pliers

Optional: Apply 1 drop of Loctite Blue 243 to the threads of the Interface Cap (7) and Tube Sub-Assembly (2)

Torque Specifications: tighten Interface Cap (7) and Tube Sub-Assembly (2) to 12 in-lbs (1.36 N-m)

7. Return the Locking Ring (11) to its original position and slide the Tube/Plunger Assembly (2, 3, 6-11) through the Coil Assembly (1)

NOTE: The Coil Assembly (1) should be oriented with the MetriPack connectors facing away from the Interface Cap (7)

8. Place the Stainless Steel Washer (5) above the Coil Assembly (1) and tighten the Nylon Nut (4) to the Tube/Plunger Assembly (2, 3, 6-11)

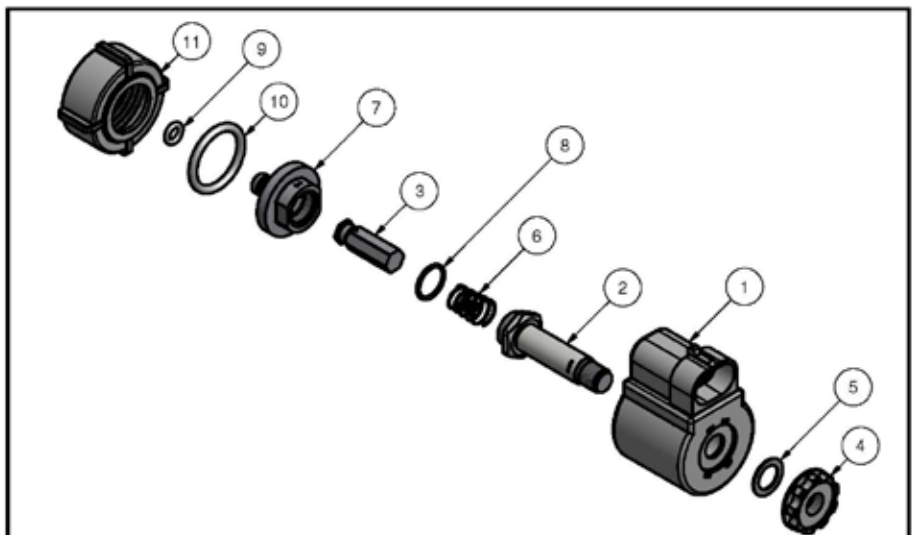

ITEM	PART NUMBER	DESCRIPTION
1	CP55296-12	12 VOLT COIL ASSEMBLY (55295-1-12, 55295-2-12, & 55295-4-12)
1A	CP55296-24	24 VOLT COIL ASSEMBLY (55295-1-24, 55295-2-24, & 55295-4-24)
2	N/A	TUBE SUB ASSEMBLY
3	N/A	PLUNGER SUB-ASSEMBLY
4	N/A	NUT, NYLON-BLACK
5	N/A	WASHER, 303 STAINLESS STEEL
6	N/A	SPRING, 302 STAINLESS STEEL
7	N/A	INTERFACE CAP, 303 STAINLESS STEEL (55295-1-12 & 55295-4-12)
7A	N/A	INTERFACE CAP, 303 STAINLESS STEEL (55295-2-12)
8	N/A	O-RING, VITON
9	N/A	O-RING, VITON (55295-1-12 & 55295-4-12)
9A	N/A	O-RING, VITON (55295-2-12)
10	N/A	O-RING, VITON (55295-1-12 & 55295-2-12)
10A	N/A	GASKET, VITON (55295-4-12)
11	N/A	LOCKING RING, NYLON-BLACK
AB55295-1-KIT, SPARE PARTS KIT (INCLUDES 3, 6, 8, 9, 10)		
AB55295-2-KIT, SPARE PARTS KIT (INCLUDES 3, 6, 8, 9A, 10)		
AB55295-4-KIT, SPARE PARTS KIT (INCLUDES 3, 6, 8, 9, 10A)		

DESCRIPTION: 55295-1-12, 55295-2-12, 55295-4-12, 55295-1-24, 55295-2-24, 55295-4-24 e-CHEMSAVER® SOLENOID OPERATED ELECTRIC SHUT-OFF VALVE	 Spraying Systems Co.® Spray Nozzles and Accessories P.O. Box 7900 - Wheaton, IL 60189-7900	REVISION NO.:	PARTS LIST PL55295
		REFERENCE:	SHEET:

©Spraying Systems Co.

Figure 36: Metric

Tip No. (Mesh Size)	Gauge Pressure (Bar)	Rated L/min	ΔP	Tip		Minimum Duty Cycle:						Tip Spacing 50 cm										
				Pressure (Bar)	Flow (L/Min)	XR/XRC	TT	T.J60	TT.J60	A.I.TT.J60	30%	5 km/h l/ha	6 km/h l/ha	8 km/h l/ha	10 km/h l/ha	12 km/h l/ha	14 km/h l/ha	16 km/h l/ha	18 km/h l/ha	20 km/h l/ha		
																					M	F
11000 XR.XRC TT T.J60 TT.J60 A.I.TT.J60 (50)	1.5	0.83	0.1	1.4	0.81	M	VC	-	-	-	-	-	-	58 to 194	49 to 162	36 to 122	29 to 97	24 to 81	21 to 69	18 to 61	16 to 54	15 to 49
	2	0.96	0.1	1.9	0.94	F	VC	-	-	-	-	-	-	68 to 226	56 to 188	42 to 141	34 to 113	28 to 94	24 to 81	21 to 71	19 to 63	17 to 50
	3	1.10	0.1	2.9	1.16	F	C	F	C	VC	-	-	-	84 to 270	70 to 232	52 to 174	42 to 139	35 to 116	30 to 99	26 to 87	23 to 77	21 to 70
	4	1.36	0.1	3.9	1.34	F	M	F	M	C	-	-	-	96 to 322	80 to 260	60 to 201	48 to 161	40 to 134	34 to 115	30 to 101	27 to 89	24 to 80
	5	1.52	0.2	4.0	1.49	-	M	-	-	-	-	-	-	107 to 350	89 to 290	67 to 224	54 to 179	45 to 149	34 to 112	30 to 99	27 to 89	24 to 80
	6	1.67	0.2	5.8	1.64	-	E	-	-	-	-	-	-	148 to 394	98 to 328	74 to 246	60 to 197	49 to 164	42 to 141	37 to 122	33 to 108	30 to 98
11004 XR.XRC TT T.J60 TT.J60 A.I.TT.J60 (50)	1.5	1.12	0.1	1.4	1.08	M	VC	-	-	-	-	-	-	78 to 259	65 to 216	49 to 162	39 to 130	32 to 108	28 to 93	24 to 81	22 to 72	19 to 65
	2	1.29	0.1	1.9	1.25	M	C	-	-	-	-	-	-	90 to 300	75 to 250	56 to 188	45 to 150	38 to 125	32 to 107	28 to 94	25 to 83	23 to 75
	3	1.58	0.2	3.8	1.53	F	M	F	M	C	VC	-	-	110 to 367	92 to 306	69 to 230	55 to 184	46 to 153	39 to 131	34 to 115	31 to 102	28 to 92
	4	1.82	0.2	3.8	1.77	F	M	F	M	C	VC	-	-	127 to 425	100 to 354	80 to 266	64 to 212	53 to 177	46 to 152	40 to 133	35 to 118	32 to 106
	5	2.04	0.3	4.7	1.98	-	M	-	-	-	-	-	-	143 to 475	119 to 396	89 to 297	71 to 230	59 to 198	51 to 170	45 to 149	40 to 132	36 to 119
	6	2.23	0.3	5.7	2.17	-	E	-	-	-	-	-	-	155 to 521	130 to 434	98 to 326	78 to 260	65 to 217	56 to 186	49 to 163	43 to 145	39 to 130
11005 XR.XRC TT T.J60 TT.J60 A.I.TT.J60 (50)	1.5	1.39	0.2	1.3	1.32	M	VC	-	-	-	-	-	-	95 to 317	79 to 264	59 to 190	49 to 150	40 to 132	34 to 113	30 to 99	26 to 80	24 to 79
	2	1.61	0.2	1.8	1.53	M	C	-	-	-	-	-	-	110 to 367	92 to 306	69 to 230	55 to 184	46 to 153	39 to 131	34 to 115	31 to 102	28 to 92
	3	1.97	0.3	2.7	1.88	M	C	M	C	XC	VC	-	-	135 to 451	113 to 376	85 to 282	68 to 226	56 to 188	48 to 161	42 to 141	38 to 125	34 to 113
	4	2.27	0.3	3.7	2.17	F	M	F	M	C	VC	-	-	156 to 521	130 to 434	98 to 326	78 to 260	65 to 217	56 to 186	49 to 163	43 to 145	39 to 130
	5	2.54	0.4	4.6	2.43	-	M	-	-	-	-	-	-	175 to 583	146 to 486	109 to 365	87 to 292	73 to 243	62 to 208	55 to 182	49 to 162	44 to 146
	6	2.79	0.5	5.5	2.67	-	E	-	-	-	-	-	-	192 to 611	160 to 534	120 to 401	95 to 320	80 to 267	69 to 229	60 to 200	53 to 178	48 to 160
11006 XR.XRC TT T.J60 TT.J60 A.I.TT.J60 (50)	1.5	1.68	0.2	1.3	1.56	M	VC	-	-	-	-	-	-	112 to 374	94 to 312	70 to 234	56 to 187	47 to 156	40 to 134	35 to 117	31 to 104	28 to 94
	2	1.94	0.3	1.7	1.81	M	VC	-	-	-	-	-	-	130 to 434	109 to 362	81 to 272	65 to 217	54 to 181	47 to 155	41 to 136	36 to 121	33 to 109
	3	2.37	0.4	2.6	2.22	M	C	M	C	XC	VC	-	-	160 to 533	133 to 444	100 to 333	80 to 266	67 to 222	57 to 190	50 to 167	44 to 140	40 to 133
	4	2.74	0.5	3.5	2.57	M	M	F	M	C	VC	-	-	185 to 617	154 to 514	116 to 386	93 to 308	77 to 257	66 to 220	58 to 193	51 to 171	46 to 154
	5	3.06	0.6	4.4	2.87	F	M	F	M	C	VC	-	-	207 to 689	172 to 574	129 to 431	103 to 344	86 to 287	74 to 246	65 to 215	57 to 191	52 to 172
	6	3.35	0.7	5.3	3.15	-	E	-	-	-	-	-	-	227 to 756	189 to 630	142 to 473	113 to 378	95 to 315	81 to 270	71 to 236	63 to 210	57 to 180
11008 XR.XRC TT T.J60 TT.J60 A.I.TT.J60 (50)	1.5	2.23	0.3	1.2	1.96	C	XC	-	-	-	-	-	-	141 to 470	118 to 392	88 to 294	71 to 235	59 to 196	50 to 168	44 to 147	39 to 131	35 to 118
	2	2.58	0.4	1.6	2.28	C	VC	-	-	-	-	-	-	164 to 547	137 to 456	103 to 342	82 to 274	68 to 228	59 to 195	51 to 171	46 to 152	41 to 137
	3	3.16	0.6	2.4	2.81	M	M	M	M	VC	VC	UC	-	202 to 674	169 to 562	126 to 422	101 to 337	84 to 281	72 to 241	63 to 211	56 to 187	51 to 169
	4	3.65	0.8	3.2	3.25	M	M	M	M	C	XC	VC	-	234 to 780	195 to 650	146 to 488	117 to 390	98 to 325	84 to 279	73 to 244	65 to 217	59 to 195
	5	4.09	1.0	4.0	3.64	M	M	M	M	C	XC	VC	-	262 to 874	218 to 729	164 to 546	131 to 437	109 to 364	94 to 312	82 to 273	73 to 243	66 to 219
	6	4.47	1.2	4.8	3.99	-	E	-	-	-	-	-	-	287 to 958	239 to 798	180 to 599	144 to 479	120 to 399	103 to 342	90 to 299	80 to 266	72 to 239
11010 T.J60 TT.J60 A.I.TT.J60 (50)	1.5	2.79	0.5	1.0	2.28	VC	UC	-	-	-	-	-	-	164 to 547	137 to 456	103 to 342	82 to 274	68 to 228	59 to 195	51 to 171	46 to 152	41 to 137
	2	3.23	0.7	1.3	2.64	C	XC	-	-	-	-	-	-	190 to 634	158 to 528	119 to 386	95 to 317	79 to 264	68 to 226	59 to 198	53 to 176	48 to 158
	3	3.95	1.0	2.0	3.29	C	VC	M	M	VC	VC	UC	-	234 to 780	195 to 650	146 to 488	117 to 390	98 to 325	84 to 279	73 to 244	65 to 217	59 to 196
	4	4.56	1.3	2.7	3.78	C	VC	M	M	VC	VC	UC	-	271 to 902	226 to 752	169 to 564	135 to 451	113 to 378	97 to 322	85 to 282	75 to 251	68 to 235
	5	5.10	1.6	3.4	4.21	M	C	M	M	VC	VC	XC	-	303 to 1010	253 to 842	189 to 632	152 to 505	126 to 421	108 to 361	95 to 316	84 to 281	76 to 253
	6	5.59	1.9	4.1	4.61	M	C	M	M	C	XC	XC	-	332 to 1106	277 to 922	207 to 692	166 to 553	130 to 461	119 to 395	104 to 346	92 to 307	83 to 277

SPEED RANGE AVAILABLE AT GIVEN N NOZZLE SIZE AND APPLICATION RATE

Figure 37: US

Tip No. (Mesh Size)	Gauge Pressure (PSI)	Rated GPM	ΔP	Tip		Minimum Duty Cycle: 30%						Tip Spacing 20 inches																		
				PSI	Flow	XR/XRC		TJ680		AUTJ680		5.0 GPA		7.5 GPA		10.0 GPA		12.0 GPA		15.0 GPA		17.5 GPA		20.0 GPA		25.0 GPA		30.0 GPA		
						M	F	M	F	M	F	M	F	M	F	M	F	M	F	M	F	M	F	M	F	M	F	M	F	M
11003 XR XRC TT TJ680 TJ680 AUTJ680 (50)	20	0.21	1	19	0.21	M	F	VC	-	-	-	3.7 to 12.5	2.5 to 8.3	1.9 to 6.2	1.6 to 5.2	1.2 to 4.2	1.1 to 3.6	0.9 to 3.1	0.7 to 2.5											
	30	0.26	1	29	0.25	M	F	VC	-	-	-	4.5 to 14.9	3.0 to 9.9	2.2 to 7.4	1.9 to 6.2	1.5 to 5.0	1.3 to 4.5	1.1 to 3.7	0.9 to 3.0	0.7 to 2.5										
	40	0.30	2	30	0.29	M	F	VC	-	-	-	5.2 to 17.2	3.4 to 11.5	2.8 to 8.6	2.2 to 7.2	1.7 to 5.7	1.5 to 4.9	1.3 to 4.3	1.0 to 3.3	0.9 to 2.9										
	50	0.34	2	48	0.33	M	F	VC	-	-	-	5.9 to 19.6	3.9 to 13.1	3.2 to 9.8	2.5 to 8.2	2.0 to 6.5	1.7 to 5.6	1.5 to 4.9	1.2 to 3.9	1.0 to 3.3										
	60	0.37	2	58	0.36	M	F	VC	-	-	-	6.4 to 21	4.3 to 14.3	3.2 to 10.7	2.7 to 8.9	2.1 to 7.1	1.8 to 6.1	1.6 to 5.3	1.3 to 3.6	1.1 to 3.6										
11004 XR XRC TT TJ680 TJ680 AUTJ680 (50)	20	0.40	3	67	0.39	M	F	VC	-	-	-	6.9 to 23	4.6 to 15.4	3.5 to 11.6	2.9 to 9.7	2.3 to 7.7	2.0 to 6.6	1.7 to 5.8	1.4 to 4.6	1.2 to 3.9										
	30	0.48	3	77	0.41	M	F	VC	-	-	-	7.3 to 24	4.9 to 16.2	3.7 to 12.2	3.0 to 10.1	2.4 to 8.1	2.1 to 7.0	1.8 to 6.1	1.5 to 4.9	1.2 to 4.1										
	40	0.49	3	37	0.39	M	F	VC	-	-	-	6.1 to 20	4.0 to 13.5	3.0 to 10.1	2.5 to 8.4	2.0 to 6.7	1.7 to 5.8	1.5 to 5.0	1.2 to 4.0	1.0 to 3.4										
	50	0.45	3	47	0.44	M	F	VC	-	-	-	6.9 to 23	4.6 to 15.4	3.5 to 11.6	2.9 to 9.7	2.3 to 7.7	2.0 to 6.6	1.7 to 5.8	1.4 to 4.6	1.2 to 3.9										
	60	0.49	4	56	0.48	M	F	VC	-	-	-	7.8 to 26	5.2 to 17.4	3.9 to 13.1	3.3 to 10.9	2.6 to 8.7	2.2 to 7.5	2.0 to 6.5	1.6 to 5.2	1.3 to 4.4										
11006 XR XRC TT TJ680 TJ680 AUTJ680 (50)	20	0.57	5	66	0.51	M	F	VC	-	-	-	8.5 to 29	5.7 to 19.0	4.3 to 14.3	3.6 to 11.9	2.9 to 9.5	2.4 to 8.1	2.1 to 7.1	1.7 to 5.7	1.4 to 4.8										
	30	0.35	2	19	0.27	M	F	VC	-	-	-	9.1 to 30	6.5 to 20	4.5 to 15.1	3.8 to 12.6	3.0 to 10.1	2.6 to 8.7	2.3 to 7.6	2.0 to 6.5	1.7 to 5.4										
	40	0.43	3	27	0.33	M	F	VC	-	-	-	9.8 to 33	6.5 to 22	4.9 to 16.3	4.1 to 13.6	3.3 to 10.9	2.8 to 9.3	2.5 to 8.2	2.0 to 6.5	1.6 to 5.4										
	50	0.50	3	36	0.48	M	F	VC	-	-	-	5.9 to 19.6	3.9 to 13.1	2.9 to 9.8	2.5 to 8.2	2.0 to 6.5	1.7 to 5.8	1.5 to 4.9	1.2 to 3.9	1.0 to 3.3										
	60	0.56	4	46	0.53	M	F	VC	-	-	-	7.3 to 24	4.9 to 16.2	3.7 to 12.2	3.0 to 10.1	2.4 to 8.1	2.1 to 7.0	1.8 to 6.1	1.5 to 4.9	1.2 to 4.1										
11008 XR XRC TT TJ680 TJ680 AUTJ680 (50)	20	0.71	7	73	0.68	M	F	VC	-	-	-	10.3 to 34	7.5 to 25	5.6 to 18.7	4.7 to 15.7	3.1 to 10.5	2.7 to 9.0	2.4 to 7.9	1.9 to 6.3	1.6 to 5.2										
	30	0.42	3	17	0.39	M	F	VC	-	-	-	11.2 to 37	7.5 to 25	5.2 to 17.2	4.3 to 14.4	3.4 to 11.5	3.0 to 9.8	2.6 to 8.6	2.1 to 6.9	1.7 to 5.7										
	40	0.60	5	35	0.56	M	F	VC	-	-	-	12.1 to 40	8.1 to 27	6.1 to 20	4.7 to 15.6	3.7 to 12.5	3.2 to 10.7	2.8 to 9.4	2.2 to 7.5	1.9 to 6.2										
	50	0.67	6	44	0.63	M	F	VC	-	-	-	6.9 to 23	4.6 to 15.4	4.3 to 14.3	3.6 to 11.9	2.9 to 9.5	2.4 to 8.1	2.1 to 7.1	1.7 to 5.7	1.4 to 4.8										
	60	0.73	7	53	0.69	M	F	VC	-	-	-	8.1 to 27	5.7 to 19.0	4.3 to 14.3	3.6 to 11.9	2.9 to 9.5	2.4 to 8.1	2.1 to 7.1	1.7 to 5.7	1.4 to 4.8										
11008 XR XRC TT TJ680 TJ680 AUTJ680 (50)	20	0.85	9	71	0.80	M	F	VC	-	-	-	12.3 to 41	8.2 to 27	6.1 to 20	5.1 to 17.1	4.1 to 13.7	3.5 to 11.7	3.1 to 10.2	2.5 to 8.2	2.0 to 6.8										
	30	0.57	5	15	0.50	M	F	VC	-	-	-	13.2 to 44	8.8 to 29	6.6 to 22	5.5 to 18.3	4.4 to 14.7	3.8 to 12.6	3.3 to 11.0	2.6 to 8.8	2.2 to 7.3										
	40	0.69	6	24	0.61	M	F	VC	-	-	-	14.3 to 48	9.5 to 32	7.1 to 24	5.9 to 19.0	4.8 to 15.8	4.1 to 13.6	3.6 to 11.9	2.9 to 9.5	2.4 to 7.9										
	50	0.89	8	32	0.71	M	F	VC	-	-	-	8.9 to 30	5.9 to 19.0	4.5 to 14.9	3.7 to 12.4	3.0 to 9.9	2.5 to 8.5	2.2 to 7.4	1.8 to 5.9	1.5 to 5.0										
	60	0.98	10	40	0.79	M	F	VC	-	-	-	10.9 to 36	7.2 to 24	5.4 to 18.1	4.5 to 15.1	3.6 to 12.1	3.1 to 10.4	2.7 to 9.1	2.2 to 7.2	1.8 to 6.0										
11010 TJ680 TJ680 AUTJ680 (50)	20	0.87	10	20	0.71	M	F	VC	-	-	-	14.1 to 47	9.4 to 31	7.0 to 23	5.9 to 19.6	4.7 to 15.6	4.0 to 13.4	3.5 to 11.7	2.8 to 9.4	2.3 to 7.8										
	30	1.00	13	27	0.82	M	F	VC	-	-	-	15.5 to 52	10.3 to 34	7.8 to 26	6.5 to 22	5.2 to 17.2	4.4 to 14.8	3.9 to 12.9	3.1 to 10.3	2.6 to 8.5										
	40	1.12	16	34	0.92	M	F	VC	-	-	-	16.8 to 56	11.2 to 37	8.4 to 28	7.0 to 23	5.6 to 18.6	4.8 to 16.8	4.2 to 14.8	3.4 to 11.2	2.8 to 9.3										
	50	1.22	19	41	1.01	M	F	VC	-	-	-	10.0 to 60	12.0 to 40	9.0 to 30	7.5 to 25	6.0 to 20.0	5.1 to 17.1	4.5 to 15.0	3.6 to 12.0	3.0 to 10.0										
	60	1.32	22	48	1.09	M	F	VC	-	-	-	12.7 to 42	8.4 to 28	6.3 to 21	5.3 to 17.6	4.2 to 14.1	3.6 to 12.0	3.2 to 10.5	2.5 to 8.4	2.1 to 7.0										
XR XRC TT	20	1.41	25	55	1.17	M	F	VC	-	-	-	14.6 to 49	9.7 to 32	7.3 to 24	6.1 to 20	4.9 to 16.2	4.2 to 13.9	3.7 to 12.2	2.9 to 9.7	2.4 to 8.1										
	30	1.41	25	55	1.17	M	F	VC	-	-	-	16.4 to 55	10.9 to 36	8.2 to 27	6.8 to 23	5.5 to 18.2	4.7 to 15.6	4.1 to 13.7	3.3 to 10.9	2.7 to 9.1										
	40	1.41	25	55	1.17	M	F	VC	-	-	-	18.0 to 60	12.0 to 40	9.0 to 30	7.5 to 25	6.0 to 20.0	5.1 to 17.1	4.5 to 15.0	3.6 to 12.0	3.0 to 10.0										
	50	1.41	25	55	1.17	M	F	VC	-	-	-	19.4 to 65	12.9 to 43	9.7 to 32	8.1 to 27	6.5 to 22	5.5 to 18.5	4.9 to 16.2	3.9 to 12.9	3.2 to 10.8										
	60	1.41	25	55	1.17	M	F	VC	-	-	-	21.0 to 69	13.9 to 46	10.4 to 35	8.7 to 29	6.9 to 23	6.0 to 20.0	5.2 to 17.4	4.2 to 13.9	3.5 to 11.6										

Figure 39: Dual Tip Mode - US

Tip No. (Mesh Size)	Gauge Pressure (PSI)	Rated GPM	ΔP	Tip		Minimum Duty Cycle:						Tip Spacing 20 inches									
				PSI	Flow	30%															
						XR/XRC	TT	TJ60	TTJ60	ATTJ60	5.0 GPA	10.0 GPA	15.0 GPA	20.0 GPA	25.0 GPA	30.0 GPA	35.0 GPA	40.0 GPA	50.0 GPA		
11003 XR/XRC TT TJ60 TTJ60 ATTJ60 (50)	20	0.21	1	19	0.21	M	VC	-	-	-	-	3.7 to 25	1.9 to 12.5	1.2 to 8.3	0.9 to 6.2	0.7 to 5.0	0.6 to 4.2	0.5 to 3.6	0.5 to 3.1	0.4 to 2.5	
	30	0.26	1	29	0.25	F	VC	XC	XC	XC	4.5 to 30	2.2 to 14.9	1.5 to 9.9	1.1 to 7.4	0.9 to 5.9	0.7 to 5.0	0.6 to 4.2	0.5 to 3.7	0.4 to 3.0		
	40	0.30	2	38	0.29	F	C	F	VC	VC	5.2 to 34	2.6 to 17.2	1.7 to 11.5	1.3 to 9.8	1.0 to 6.9	0.9 to 5.7	0.7 to 4.9	0.6 to 4.3	0.5 to 3.4		
	50	0.34	2	48	0.33	F	M	M	M	M	5.9 to 39	2.9 to 19.6	2.0 to 13.1	1.5 to 10.6	1.2 to 7.8	1.0 to 6.5	0.8 to 5.6	0.7 to 4.9	0.6 to 3.9		
	60	0.37	2	58	0.36	F	M	F	M	M	6.4 to 43	3.2 to 21	2.1 to 14.3	1.6 to 10.7	1.3 to 8.6	1.1 to 7.1	0.9 to 6.1	0.8 to 5.3	0.6 to 4.3		
11004 XR/XRC TT TJ60 TTJ60 ATTJ60 (50)	70	0.40	3	67	0.39	-	M	M	M	M	6.9 to 46	3.5 to 23	2.3 to 15.4	1.7 to 11.6	1.4 to 9.3	1.2 to 7.7	1.0 to 6.6	0.9 to 5.8	0.7 to 4.6		
	80	0.42	3	77	0.41	-	M	M	M	M	7.3 to 49	3.7 to 24	2.4 to 16.0	1.8 to 12.2	1.5 to 9.7	1.2 to 8.1	1.0 to 7.0	0.9 to 6.1	0.7 to 4.9		
	20	0.28	1	19	0.27	M	VC	-	-	-	4.8 to 32	2.4 to 16.0	1.6 to 10.7	1.2 to 8.0	1.0 to 6.4	0.8 to 5.3	0.7 to 4.6	0.6 to 3.7			
	30	0.35	2	28	0.34	M	C	C	C	XC	6.1 to 40	3.0 to 20	2.0 to 13.5	1.5 to 10.1	1.2 to 8.1	1.0 to 6.7	0.9 to 5.8	0.8 to 5.0	0.6 to 4.0		
	40	0.40	3	37	0.39	M	C	F	VC	VC	6.9 to 46	3.5 to 23	2.3 to 15.4	1.7 to 11.6	1.4 to 9.3	1.2 to 7.7	1.0 to 6.5	0.9 to 5.8	0.7 to 4.6		
11005 XR/XRC TT TJ60 TTJ60 ATTJ60 (50)	50	0.45	3	47	0.44	F	M	F	M	M	7.8 to 52	3.9 to 26	2.6 to 17.4	2.0 to 13.1	1.6 to 10.5	1.3 to 8.7	1.1 to 7.5	1.0 to 6.5	0.8 to 5.2		
	60	0.49	4	56	0.48	F	M	M	M	M	8.6 to 57	4.3 to 29	2.9 to 19.0	2.1 to 14.3	1.7 to 11.4	1.4 to 9.5	1.2 to 8.1	1.1 to 7.1	0.9 to 6.3		
	70	0.53	4	66	0.51	-	M	M	M	M	9.4 to 63	4.7 to 31	3.1 to 21	2.4 to 15.7	1.9 to 12.6	1.6 to 10.5	1.3 to 9.0	1.2 to 7.9	0.9 to 6.3		
	80	0.57	5	75	0.55	-	M	M	M	M	10.3 to 69	5.2 to 34	3.4 to 23	2.6 to 17.2	2.1 to 13.8	1.7 to 11.5	1.5 to 9.8	1.3 to 8.6	1.0 to 6.9		
	20	0.35	2	18	0.33	M	VC	-	-	XC	5.9 to 39	2.9 to 19.6	2.0 to 13.1	1.5 to 10.3	1.2 to 7.8	1.0 to 6.5	0.8 to 5.6	0.7 to 4.9	0.6 to 3.9		
11006 XR/XRC TT TJ60 TTJ60 ATTJ60 (50)	30	0.43	3	27	0.41	M	VC	-	-	XC	7.3 to 49	3.7 to 24	2.4 to 16.2	1.8 to 12.2	1.5 to 9.7	1.2 to 8.1	1.0 to 7.0	0.9 to 5.7	0.7 to 4.9		
	40	0.50	4	36	0.48	M	C	M	XC	XC	8.6 to 57	4.3 to 29	2.9 to 19.0	2.1 to 14.3	1.7 to 11.4	1.4 to 9.5	1.2 to 8.1	1.1 to 7.1	0.9 to 5.7		
	50	0.56	4	46	0.53	F	M	M	M	M	9.4 to 63	4.7 to 31	3.1 to 21	2.4 to 15.7	1.9 to 12.6	1.6 to 10.5	1.3 to 9.0	1.2 to 7.9	0.9 to 6.3		
	60	0.61	5	55	0.58	F	M	M	M	M	10.3 to 69	5.2 to 34	3.4 to 23	2.6 to 17.2	2.1 to 13.8	1.7 to 11.5	1.5 to 9.8	1.3 to 8.6	1.0 to 6.9		
	70	0.66	6	64	0.63	F	M	M	M	M	11.2 to 75	5.6 to 37	3.7 to 25	2.8 to 18.7	2.2 to 15.0	1.9 to 12.5	1.6 to 10.7	1.4 to 9.4	1.1 to 7.5		
11008 XR/XRC TT TJ60 TTJ60 ATTJ60 (90)	80	0.71	7	73	0.68	-	F	F	C	C	12.1 to 81	6.1 to 40	4.0 to 27	3.0 to 20	2.4 to 16.2	2.0 to 13.1	1.7 to 11.5	1.5 to 10.1	1.2 to 8.1		
	20	0.42	3	17	0.39	C	XC	-	-	XC	6.9 to 46	3.5 to 23	2.3 to 15.4	1.7 to 11.6	1.4 to 9.3	1.2 to 7.7	1.0 to 6.5	0.9 to 5.8	0.7 to 4.6		
	30	0.52	4	26	0.48	M	VC	-	-	XC	8.6 to 57	4.3 to 29	2.9 to 19.0	2.1 to 14.3	1.7 to 11.4	1.4 to 9.5	1.2 to 8.1	1.1 to 7.1	0.9 to 5.7		
	40	0.60	5	35	0.56	M	C	M	XC	XC	10.0 to 67	5.0 to 33	3.3 to 22	2.5 to 16.6	2.0 to 13.3	1.7 to 11.1	1.4 to 9.5	1.2 to 8.3	1.0 to 6.7		
	50	0.67	6	44	0.63	M	M	M	M	M	11.2 to 75	5.6 to 37	3.7 to 25	2.8 to 18.7	2.2 to 15.0	1.9 to 12.5	1.6 to 10.7	1.4 to 9.4	1.1 to 7.5		
11010 TJ60 TTJ60 ATTJ60 (90)	60	0.73	7	53	0.69	M	M	M	M	M	12.3 to 82	6.1 to 41	4.1 to 27	3.1 to 20	2.5 to 16.4	2.0 to 13.7	1.8 to 11.7	1.5 to 10.2	1.2 to 8.2		
	70	0.79	8	62	0.74	F	M	M	M	M	13.2 to 88	6.6 to 44	4.4 to 29	3.3 to 22	2.6 to 17.6	2.2 to 14.7	1.9 to 12.6	1.6 to 11.0	1.3 to 8.8		
	80	0.85	9	71	0.80	-	M	M	M	M	14.3 to 95	7.1 to 48	4.8 to 32	3.6 to 24	2.9 to 19.0	2.4 to 15.8	2.0 to 13.6	1.8 to 11.9	1.4 to 9.5		
	20	0.57	5	15	0.50	C	XC	-	-	XC	8.9 to 59	4.5 to 30	3.0 to 19.8	2.2 to 14.9	1.8 to 11.9	1.5 to 9.9	1.3 to 8.5	1.1 to 7.4	0.9 to 5.9		
	30	0.69	6	24	0.61	C	C	-	-	UC	10.9 to 72	5.4 to 36	3.6 to 24	2.7 to 18.1	2.2 to 14.5	1.8 to 12.1	1.6 to 10.4	1.4 to 9.1	1.1 to 7.2		
11010 TJ60 TTJ60 ATTJ60 (90)	40	0.80	8	32	0.71	C	C	-	-	UC	12.7 to 84	6.3 to 42	4.2 to 28	3.2 to 21	2.5 to 16.9	2.1 to 14.1	1.8 to 12.0	1.6 to 10.5	1.3 to 8.4		
	50	0.89	10	40	0.79	C	M	-	-	UC	14.1 to 94	7.0 to 47	4.7 to 31	3.5 to 23	2.8 to 18.8	2.3 to 15.6	2.0 to 13.4	1.8 to 11.7	1.4 to 9.4		
	60	0.98	12	48	0.87	M	M	-	-	XC	15.5 to 103	7.8 to 52	5.2 to 34	3.9 to 26	3.1 to 21	2.6 to 17.2	2.2 to 14.8	1.9 to 12.9	1.6 to 10.3		
	70	1.06	14	56	0.94	M	M	-	-	VC	16.8 to 112	8.4 to 56	5.6 to 37	4.2 to 28	3.4 to 22	2.8 to 18.6	2.4 to 16.0	2.1 to 14.0	1.7 to 11.2		
	80	1.13	16	64	1.01	M	M	-	-	VC	18.0 to 120	9.0 to 60	6.0 to 40	4.5 to 30	3.6 to 24	3.0 to 20.0	2.6 to 17.1	2.2 to 15.0	1.8 to 12.0		
11010 TJ60 TTJ60 ATTJ60 (90)	30	0.87	10	20	0.71	C	XC	-	-	UC	12.7 to 84	6.3 to 42	4.2 to 28	3.2 to 21	2.5 to 16.9	2.1 to 14.1	1.8 to 12.0	1.6 to 10.5	1.3 to 8.4		
	40	1.00	13	27	0.82	C	XC	-	-	UC	14.6 to 97	7.3 to 49	4.9 to 32	3.7 to 24	2.9 to 19.5	2.4 to 16.2	2.1 to 13.9	1.8 to 12.2	1.5 to 9.7		
	50	1.12	16	34	0.92	C	VC	-	-	UC	16.4 to 109	8.2 to 55	5.5 to 36	4.1 to 27	3.3 to 22	2.7 to 18.2	2.3 to 15.6	2.0 to 13.7	1.6 to 10.9		
	60	1.22	19	41	1.01	M	VC	-	-	UC	18.0 to 120	9.0 to 60	6.0 to 40	4.5 to 30	3.6 to 24	3.0 to 20.0	2.6 to 17.1	2.2 to 15.0	1.8 to 12.0		
	70	1.32	22	48	1.09	M	VC	-	-	UC	19.4 to 129	9.7 to 65	6.5 to 43	4.9 to 32	3.9 to 26	3.2 to 22	2.8 to 18.5	2.4 to 16.2	1.9 to 12.9		
XR/XRC TT	80	1.41	25	55	1.17	M	C	-	-	XC	21 to 139	10.4 to 69	6.9 to 46	5.2 to 35	4.2 to 28	3.5 to 23	3.0 to 19.9	2.6 to 17.4	2.1 to 13.9		

Figure 40: Dual Nozzle Mode – Metric

Tip No. (Mesh Size)	Gauge Pressure (Bar)	Rated L/Min	ΔP	Tip		Minimum Duty Cycle:				30%		Tip Spacing 50 cm									
				Pressure (Bar)	Flow (L/Min)	XR/XRC	TT	I-J60	T1-J60	A1T1-J60	50 l/ha km/h	100 l/ha km/h	150 l/ha km/h	200 l/ha km/h	250 l/ha km/h	300 l/ha km/h	350 l/ha km/h	400 l/ha km/h	500 l/ha km/h		
11003 XR-XRC TT T-J60 TT-J60 A1T1-J60 (50)	1.5	0.03	0.1	1.4	0.01	M	VC	-	-	-	-	5.0 to 39	2.9 to 19	1.9 to 13	1.5 to 9.7	1.2 to 7.0	1.0 to 6.5	0.8 to 5.6	0.7 to 4.9	0.6 to 3.9	
	2	0.96	0.1	1.9	0.04	F	VC	C	C	XC	VC	6.8 to 45	3.4 to 23	2.3 to 15	1.7 to 11	1.4 to 9.0	1.1 to 7.5	1.0 to 6.4	0.8 to 5.6	0.7 to 4.5	
	3	1.18	0.1	2.9	1.16	F	C	F	M	C	VC	8.4 to 56	4.2 to 28	2.8 to 19	2.1 to 14	1.7 to 11	1.4 to 9.0	1.2 to 8.0	1.0 to 7.0	0.8 to 5.6	
	4	1.36	0.1	3.9	1.34	F	M	F	M	C	VC	9.6 to 64	4.8 to 32	3.2 to 21	2.4 to 16	1.9 to 13	1.6 to 11	1.4 to 9.2	1.2 to 8.0	1.0 to 6.4	
	5	1.52	0.2	4.8	1.49	-	M	F	M	C	C	11.0 to 72	5.4 to 36	3.8 to 24	2.7 to 18	2.1 to 14	1.8 to 12	1.5 to 10	1.3 to 8.9	1.1 to 7.2	
	6	1.67	0.2	5.8	1.64	-	F	VC	-	M	C	12.0 to 79	5.9 to 39	3.9 to 26	2.9 to 20	2.4 to 16	2.0 to 13	1.7 to 11	1.5 to 9.8	1.2 to 7.9	
11004 XR-XRC TT T-J60 TT-J60 A1T1-J60 (50)	1.5	1.12	0.1	1.4	1.08	M	VC	-	-	-	-	7.8 to 52	3.9 to 26	2.6 to 17	1.9 to 13	1.6 to 10	1.3 to 8.6	1.1 to 7.4	1.0 to 6.5	0.8 to 5.2	
	2	1.29	0.1	1.9	1.25	M	C	C	C	XC	VC	9.0 to 60	4.5 to 30	3.0 to 20	2.3 to 15	1.8 to 12	1.5 to 10	1.3 to 8.6	1.1 to 7.5	0.9 to 6.0	
	3	1.58	0.2	2.8	1.53	F	M	F	M	C	VC	11.0 to 73	5.5 to 37	3.7 to 24	2.8 to 18	2.2 to 15	1.8 to 12	1.6 to 10	1.4 to 9.2	1.1 to 7.3	
	4	1.82	0.2	3.8	1.77	F	M	F	M	C	VC	13.0 to 85	6.4 to 42	4.2 to 28	3.2 to 21	2.5 to 17	2.1 to 14	1.8 to 12	1.6 to 11	1.3 to 8.5	
	5	2.04	0.3	4.7	1.90	-	M	F	M	C	C	14.0 to 95	7.1 to 48	4.8 to 32	3.6 to 24	2.9 to 19	2.4 to 16	2.0 to 14	1.8 to 12	1.4 to 9.5	
	6	2.23	0.3	5.7	2.17	-	F	VC	-	M	C	16.0 to 104	7.8 to 52	5.2 to 35	3.9 to 26	3.1 to 21	2.6 to 17	2.2 to 15	2.0 to 14	1.8 to 12	
11005 XR-XRC TT T-J60 TT-J60 A1T1-J60 (50)	1.5	1.39	0.2	1.3	1.32	M	VC	-	-	-	-	9.5 to 63	4.8 to 32	3.2 to 21	2.4 to 16	1.9 to 13	1.6 to 11	1.4 to 9.1	1.2 to 7.9	1.0 to 6.3	
	2	1.61	0.2	1.8	1.53	M	C	C	C	XC	VC	11.0 to 73	5.5 to 37	3.7 to 24	2.8 to 18	2.2 to 15	1.8 to 12	1.6 to 10	1.4 to 9.2	1.1 to 7.3	
	3	1.97	0.3	2.7	1.88	M	C	M	C	XC	VC	14.0 to 90	6.8 to 45	4.5 to 30	3.4 to 23	2.7 to 18	2.3 to 15	1.9 to 13	1.7 to 11	1.4 to 9.0	
	4	2.27	0.3	3.7	2.17	F	M	F	M	C	VC	16.0 to 104	7.8 to 52	5.2 to 35	3.9 to 26	3.1 to 21	2.6 to 17	2.2 to 15	2.0 to 13	1.6 to 10	
	5	2.54	0.4	4.6	2.43	-	M	F	M	C	C	17.0 to 117	8.7 to 58	5.8 to 39	4.4 to 29	3.5 to 23	2.9 to 19	2.5 to 17	2.2 to 15	1.7 to 12	
	6	2.79	0.5	5.5	2.67	-	F	VC	-	M	C	19.0 to 128	9.6 to 64	6.4 to 43	4.8 to 32	3.8 to 26	3.2 to 21	2.7 to 18	2.4 to 16	1.9 to 13	
11006 XR-XRC TT T-J60 TT-J60 A1T1-J60 (50)	1.5	1.68	0.2	1.3	1.56	M	VC	-	-	-	-	11.0 to 75	5.8 to 37	3.7 to 25	2.8 to 19	2.2 to 15	1.9 to 13	1.6 to 11	1.4 to 9.4	1.1 to 7.5	
	2	1.91	0.3	1.7	1.81	M	VC	-	VC	UC	VC	13.0 to 87	6.5 to 43	4.3 to 29	3.3 to 22	2.6 to 17	2.2 to 15	1.9 to 12	1.6 to 11	1.3 to 8.7	
	3	2.37	0.4	2.6	2.22	M	C	M	C	XC	VC	16.0 to 107	8.0 to 53	5.3 to 36	4.0 to 27	3.2 to 21	2.7 to 18	2.3 to 15	2.0 to 13	1.6 to 11	
	4	2.74	0.5	3.5	2.57	M	M	F	M	C	VC	19.0 to 123	9.3 to 62	6.2 to 41	4.6 to 31	3.7 to 25	3.1 to 21	2.6 to 18	2.3 to 15	1.9 to 12	
	5	3.06	0.6	4.4	2.87	F	M	F	M	C	C	21.0 to 138	10.6 to 69	6.9 to 46	5.2 to 34	4.1 to 28	3.4 to 23	3.0 to 20	2.6 to 17	2.1 to 14	
	6	3.35	0.7	5.3	3.15	-	F	VC	-	M	C	23.0 to 151	11.6 to 76	7.6 to 50	5.7 to 38	4.5 to 30	3.8 to 25	3.2 to 21	2.7 to 18	2.3 to 15	
11008 XR-XRC TT T-J60 TT-J60 A1T1-J60 (50)	1.5	2.23	0.3	1.2	1.80	C	XC	-	-	-	-	14.0 to 94	7.1 to 47	4.7 to 31	3.5 to 24	2.8 to 19	2.4 to 16	2.0 to 13	1.8 to 12	1.4 to 9.4	
	2	2.50	0.4	1.6	2.20	C	VC	-	VC	UC	VC	16.0 to 109	8.2 to 55	5.5 to 36	4.1 to 27	3.3 to 22	2.7 to 18	2.3 to 16	2.1 to 14	1.6 to 11	
	3	3.16	0.6	2.4	2.81	M	M	M	M	VC	VC	20.0 to 135	10.0 to 67	6.7 to 45	5.1 to 34	4.0 to 27	3.4 to 22	2.9 to 19	2.5 to 17	2.0 to 13	
	4	3.65	0.8	3.2	3.25	M	M	M	M	C	VC	23.0 to 156	12.0 to 78	7.8 to 52	5.9 to 39	4.7 to 31	3.9 to 26	3.3 to 22	2.9 to 20	2.3 to 16	
	5	4.08	1.0	4.0	3.64	M	M	M	M	C	VC	26.0 to 175	13.0 to 87	8.7 to 58	6.8 to 44	5.2 to 35	4.4 to 29	3.7 to 25	3.3 to 22	2.6 to 17	
	6	4.47	1.2	4.8	3.99	-	F	VC	-	C	VC	29.0 to 192	14.0 to 96	9.6 to 64	7.2 to 48	5.7 to 38	4.8 to 32	4.1 to 27	3.6 to 24	2.9 to 19	
11010 T-J60 TT-J60 A1T1-J60 (50)	1.5	2.79	0.5	1.0	2.28	VC	UC	-	-	-	-	16.0 to 109	8.2 to 55	5.5 to 36	4.1 to 27	3.3 to 22	2.7 to 18	2.3 to 16	2.1 to 14	1.6 to 11	
	2	3.23	0.7	1.3	2.64	C	XC	-	-	-	-	19.0 to 127	9.5 to 63	6.3 to 42	4.8 to 32	3.8 to 25	3.2 to 21	2.7 to 18	2.4 to 16	1.9 to 13	
	3	3.95	1.0	2.0	3.25	C	VC	-	VC	UC	VC	23.0 to 156	12.0 to 78	7.9 to 52	5.9 to 39	4.7 to 31	3.9 to 26	3.3 to 22	2.9 to 20	2.3 to 16	
	4	4.56	1.3	2.7	3.76	C	VC	-	VC	UC	VC	27.0 to 180	14.0 to 90	9.0 to 60	6.8 to 45	5.4 to 36	4.5 to 30	3.9 to 26	3.4 to 23	2.7 to 18	
	5	5.10	1.6	3.4	4.21	M	C	M	VC	VC	VC	30.0 to 202	15.0 to 101	10.0 to 67	7.6 to 51	6.1 to 40	5.1 to 34	4.3 to 29	3.8 to 25	3.0 to 20	
	6	5.59	1.9	4.1	4.61	M	C	M	C	VC	VC	33.0 to 221	17.0 to 111	11.0 to 74	8.3 to 55	6.6 to 44	5.5 to 37	4.7 to 32	4.1 to 28	3.3 to 22	

Figure 41: Dual Tip Mode – US – Turf

Tip No. (Mesh Size)	Gauge Pressure (PSI)	Rated GPM	ΔP	Tip		Minimum Duty Cycle: 30%						Tip Spacing 20 Inches										
				PSI	Flow	XR/XRC	TT	TJ60	TJ60	ATTJ60	1.0 Gal/1000ft ² (43.7 GPA)		1.5 Gal/1000ft ² (65.5 GPA)		2.0 Gal/1000ft ² (87.4 GPA)		2.5 Gal/1000ft ² (109 GPA)		3.0 Gal/1000ft ² (131 GPA)		4.0 Gal/1000ft ² (175 GPA)	
											MPH	MPH	MPH	MPH	MPH	MPH	MPH	MPH	MPH	MPH	MPH	MPH
11003 XR XRC TT TJ60 TTJ60 ATTJ60 (50)	20	0.21	1	19	0.21	M	VC	-	-	-	0.41to 2.9	0.31to 1.9	0.21to 1.4	0.21to 1.1	0.11to 1.0	0.11to 0.7						
	30	0.28	1	29	0.25	F	VC	C	C	0.51to 3.4	0.31to 2.3	0.31to 2.3	0.21to 1.7	0.21to 1.3	0.11to 1.0							
	40	0.39	2	38	0.29	F	C	F	F	0.51to 3.9	0.41to 2.6	0.31to 2.0	0.21to 1.6	0.21to 1.3	0.11to 1.0							
	50	0.34	2	48	0.33	F	M	F	M	0.71to 4.5	0.41to 3.0	0.31to 2.2	0.31to 1.5	0.21to 1.5	0.11to 1.0							
	60	0.37	2	58	0.36	F	M	F	M	0.71to 4.9	0.51to 3.3	0.41to 2.4	0.31to 1.6	0.21to 1.6	0.11to 1.2							
11004 XR XRC TT TJ60 TTJ60 ATTJ60 (50)	70	0.40	3	67	0.39	-	M	M	M	0.81to 5.3	0.51to 3.5	0.41to 2.7	0.31to 2.1	0.31to 1.8	0.21to 1.4							
	80	0.40	3	77	0.41	-	M	M	M	0.81to 5.6	0.51to 3.7	0.41to 2.8	0.31to 2.2	0.31to 1.9	0.21to 1.4							
	20	0.28	1	19	0.27	M	VC	-	-	0.51to 3.7	0.41to 2.4	0.31to 1.8	0.21to 1.5	0.21to 1.2	0.11to 0.9							
	30	0.35	2	28	0.31	M	C	C	C	0.71to 4.6	0.51to 3.1	0.41to 2.7	0.31to 1.8	0.21to 1.5	0.21to 1.2							
	40	0.40	3	37	0.39	M	C	F	F	0.81to 5.3	0.51to 3.5	0.41to 2.3	0.31to 1.8	0.21to 1.3	0.21to 1.3							
11005 XR XRC TT TJ60 TTJ60 ATTJ60 (50)	50	0.45	3	47	0.44	F	M	F	M	0.91to 6.0	0.61to 4.0	0.41to 3.0	0.41to 2.4	0.31to 2.0	0.21to 1.5							
	60	0.49	4	56	0.48	F	M	F	M	1.01to 6.5	0.71to 4.4	0.51to 3.3	0.41to 2.6	0.31to 2.2	0.21to 1.6							
	70	0.53	4	66	0.51	-	M	M	M	1.01to 6.9	0.71to 4.6	0.51to 3.5	0.41to 2.8	0.31to 2.3	0.21to 1.7							
	80	0.57	5	75	0.55	-	M	M	M	1.11to 7.5	0.71to 5.0	0.61to 3.7	0.41to 3.0	0.41to 2.5	0.31to 1.9							
	20	0.35	2	18	0.33	M	VC	-	-	0.71to 4.5	0.41to 3.0	0.31to 2.2	0.31to 1.8	0.21to 1.5	0.21to 1.1							
11006 XR XRC TT TJ60 TTJ60 ATTJ60 (50)	30	0.43	3	27	0.41	M	VC	C	C	0.81to 5.6	0.51to 3.7	0.41to 2.8	0.31to 2.2	0.31to 1.9	0.21to 1.4							
	40	0.50	4	36	0.48	M	C	M	M	1.01to 6.5	0.71to 4.4	0.51to 3.3	0.41to 2.6	0.31to 2.2	0.21to 1.6							
	50	0.56	4	46	0.53	F	M	F	F	1.11to 7.2	0.71to 4.8	0.51to 3.6	0.41to 2.9	0.41to 2.4	0.31to 1.8							
	60	0.61	5	55	0.58	F	M	F	M	1.21to 7.9	0.81to 5.3	0.61to 3.9	0.51to 3.2	0.41to 2.6	0.31to 2.0							
	70	0.68	6	64	0.63	F	M	F	M	1.31to 8.6	0.91to 5.7	0.61to 4.3	0.51to 3.4	0.41to 2.9	0.31to 2.1							
11008 XR XRC TT TJ60 TTJ60 ATTJ60 (50)	80	0.71	7	73	0.68	-	F	M	M	1.41to 9.2	0.91to 6.2	0.61to 4.6	0.51to 3.7	0.41to 3.1	0.31to 2.3							
	20	0.42	3	17	0.39	C	XG	-	-	0.81to 5.3	0.51to 3.5	0.41to 2.7	0.31to 2.1	0.31to 1.8	0.21to 1.3							
	30	0.52	4	26	0.48	M	VC	-	-	1.01to 6.5	0.71to 4.4	0.51to 3.3	0.41to 2.6	0.31to 2.2	0.21to 1.6							
	40	0.60	5	35	0.56	M	C	M	M	1.11to 7.6	0.81to 5.1	0.61to 3.8	0.51to 3.0	0.41to 2.5	0.31to 1.9							
	50	0.67	6	44	0.63	M	C	M	M	1.31to 8.6	0.91to 5.7	0.61to 4.3	0.51to 3.4	0.41to 2.9	0.31to 2.1							
11008 XR XRC TT TJ60 TTJ60 ATTJ60 (50)	60	0.73	7	53	0.69	M	C	M	M	1.41to 9.4	0.91to 6.3	0.71to 4.7	0.61to 3.8	0.51to 3.1	0.41to 2.3							
	70	0.79	8	62	0.74	F	M	F	F	1.51to 10.1	1.01to 6.7	0.81to 5.0	0.61to 4.0	0.51to 3.4	0.41to 2.5							
	80	0.85	9	71	0.80	-	M	M	M	1.61to 10.9	1.11to 7.3	0.81to 5.4	0.71to 4.6	0.61to 3.6	0.41to 2.7							
	20	0.57	5	15	0.50	C	XG	-	-	1.01to 6.8	0.71to 4.5	0.51to 3.4	0.41to 2.7	0.31to 2.3	0.31to 1.7							
	30	0.69	6	24	0.61	C	C	C	C	1.21to 8.3	0.81to 5.5	0.61to 4.1	0.51to 3.3	0.41to 2.8	0.31to 2.1							
11008 XR XRC TT TJ60 TTJ60 ATTJ60 (50)	40	0.80	8	32	0.71	C	C	C	C	1.41to 9.7	1.01to 6.4	0.71to 4.8	0.61to 3.9	0.51to 3.2	0.41to 2.4							
	50	0.89	10	40	0.79	M	M	M	M	1.61to 10.7	1.11to 7.2	0.81to 5.4	0.61to 4.3	0.51to 3.6	0.41to 2.7							
	60	0.98	12	48	0.87	M	M	M	M	1.81to 11.8	1.21to 7.9	0.91to 5.9	0.71to 4.7	0.61to 3.9	0.41to 3.0							
	70	1.06	14	56	0.94	M	M	M	M	1.91to 12.8	1.31to 8.5	1.01to 6.4	0.81to 5.1	0.61to 4.3	0.51to 3.2							
	80	1.13	16	64	1.01	M	M	M	M	2.11to 13.7	1.41to 9.2	1.01to 6.9	0.81to 5.5	0.61to 4.6	0.51to 3.4							
11010 TJ60 TTJ60 ATTJ60 (50)	30	0.87	10	20	0.71	C	XG	-	-	1.41to 9.7	1.01to 6.4	0.71to 4.8	0.61to 3.9	0.51to 3.2	0.41to 2.4							
	40	1.00	13	27	0.82	C	XG	-	-	1.71to 11.2	1.11to 7.4	0.81to 5.6	0.71to 4.5	0.61to 3.7	0.41to 2.8							
	50	1.12	16	34	0.92	C	VC	VC	VC	1.91to 12.5	1.31to 8.3	0.91to 6.3	0.81to 5.0	0.61to 4.2	0.51to 3.1							
	60	1.22	19	41	1.01	M	VC	VC	VC	2.11to 13.7	1.41to 9.2	1.01to 6.9	0.81to 5.5	0.71to 4.6	0.51to 3.4							
	70	1.32	22	48	1.09	M	C	C	C	2.21to 14.8	1.51to 9.9	1.11to 7.4	0.91to 5.9	0.71to 4.9	0.61to 3.7							
XR XRC TT	80	1.41	25	55	1.17	M	C	C	C	2.41to 15.9	1.61to 10.6	1.21to 8.0	1.01to 6.4	0.81to 5.3	0.61to 4.0							

DYNAJET® FLEX 7140

INSTALLATION, SETUP AND USER GUIDE

An innovative new product from TeeJet makes spraying more efficient and more productive. The DynaJet Flex system uses a touch screen controller and individual solenoids to control each spray nozzle. This innovative system works along with an existing rate controller, and allows the operator to choose specific droplet sizes that will be used for a particular job. The rate controller manages application rate, and the DynaJet Flex system uses PWM technology to control system pressure and thereby control spray droplet size. Droplet size data is built into the controller so setup is easy and droplet sizes can be changed on the go. PWM control of each nozzle delivers very large ranges of speeds and application rates with a single spray nozzle and with consistent spray quality.



www.teejet.com

A Subsidiary of  **Spraying Systems Co.®**

98-05345-ENUS-LT R1 English-US
© TeeJet Technologies 2017

Copyrights

© 2017 TeeJet Technologies. All rights reserved. No part of this document or the computer programs described in it may be reproduced, copied, photocopied, translated, or reduced in any form or by any means, electronic or machine readable, recording or otherwise, without prior written consent from TeeJet Technologies.

Trademarks

Unless otherwise noted, all other brand or product names are trademarks or registered trademarks of their respective companies or organizations.

Limitation of Liability

TEEJET TECHNOLOGIES PROVIDES THIS MATERIAL "AS IS" WITHOUT WARRANTY OF ANY KIND, EITHER EXPRESSED OR IMPLIED. NO COPYRIGHT LIABILITY OR PATENT IS ASSUMED. IN NO EVENT SHALL TEEJET TECHNOLOGIES BE LIABLE FOR ANY LOSS OF BUSINESS, LOSS OF PROFIT, LOSS OF USE OR DATA, INTERRUPTION OF BUSINESS, OR FOR INDIRECT, SPECIAL, INCIDENTAL, OR CONSEQUENTIAL DAMAGES OF ANY KIND, EVEN IF TEEJET TECHNOLOGIES HAS BEEN ADVISED OF SUCH DAMAGES ARISING FROM TEEJET TECHNOLOGIES SOFTWARE.