

Operator's



Sweep Star V62
Model 78-200-B

November 2007

Product Support:

Hwy 55 & Poplar Ave; Cameron WI 54822

1-800-891-9435 productsupport@smithco.com

CONTENTS

Introduction

Service

Diagrams

Introduction	1-10
Introduction	1
Symbols	2-3
Safe Practices	4
Specifications	5
Setup	6-9
Controls & Instruments	10
Service	11-13
Operation	11-12
Overloading Debris Hopper and Vacuum Housing Wear	12
Battery	13
Diagrams	14-17
Wiring Drawing	14-15
Hydraulic Drawing	16-17
Other	18
Declaration of Incorporation	
Warranty	

Thank you for purchasing a **SMITHCO** product.

Read this manual and all other manuals pertaining to the Sweep Star V62 carefully as they have safety, operating, assembly and maintenance instructions. Failure to do so could result in personal injury or equipment damage.

Keep manuals in a safe place after operator and maintenance personnel have read them. Right and left sides are from the operator's seat, facing forward.

All **SMITHCO** machines have a Serial Number and Model Number. Both numbers are needed when ordering parts. The serial number plate on the Sweep Star V62 is located on the left front frame. Refer to engine manual for placement of engine serial number.

For easy access record your Serial and Model numbers here.











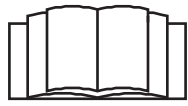



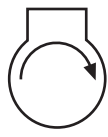
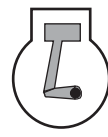
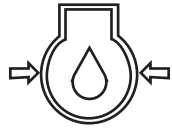

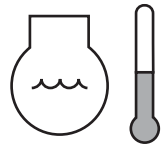
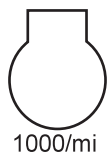
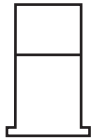
SMITHCO			CE
WAYNE, PENNSYLVANIA 19087 USA 610-688-4009 Fax 610-688-6069			
SERIAL NO.	kW/hp	DATE OF MFG.	
<input type="text"/>	<input type="text"/>	<input type="text"/>	
MODEL NO.	lb/kg Empty	lb/kg Full	
<input type="text"/>	<input type="text"/>	<input type="text"/>	



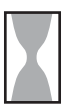
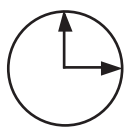
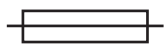

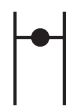



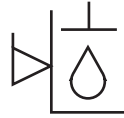

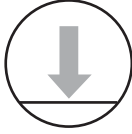

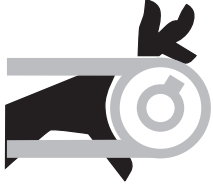

Information needed when ordering replacement parts:

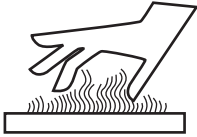
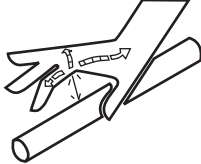
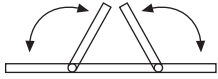
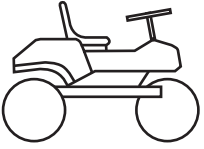
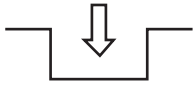
1. Model Number of machine
2. Serial Number of machine
3. Name and Part Number of part
4. Quantity of parts

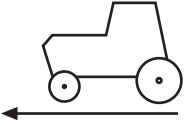
SYMBOLS

	Read Operator's Manual		Electrical Power		No Electrical Power
	Engine - Stop		Engine - Start		Engine - Run
	Engine Oil		Temperature Light		Water Temperature
	RPM 1000/mi		Gasoline		Diesel
	Glow Plug - On		Glow Plug - Off		Glow Plug
	Hour Meter		Hour Meter		Fuse
	Hand Throttle		Choke - Closed		Choke - Open
	Park Brake		Park Brake Release		Hydraulic Oil Level

	Up/Down Arrow		Down/Lower		Up/Raise
	No Smoking		Moving Parts		Manual Operation
	Pinch Point		Step		Hot Surface
	Hydraulic Fluid Penetration		Lift Arm		Tractor
	Engage		Disengage		PTO
	Ground Speed		Fast		Slow
H	High	L	Low	F	Forward
R	Reverse	N	Neutral		Warning Danger Caution

SAFE PRACTICES

1. It is your responsibility to read this manual and all publications associated with this machine (engine, accessories and attachments).
2. Never allow anyone to operate or service the machine or its attachments without proper training and instructions. Never allow minors to operate any equipment.
3. Learn the proper use of the machine, the location and purpose of all the controls and gauges before you operate the equipment. Working with unfamiliar equipment can lead to accidents.
4. Wear all the necessary protective clothing and personal safety devices to protect your head, eyes, ears, hands and feet. Operate the machine only in daylight or in good artificial light.
5. Inspect the area where the equipment will be used. Beware of overhead obstructions and underground obstacles. Stay alert for hidden hazards.
6. Never operate equipment that is not in perfect working order or without decals, guards, shields, or other protective devices in place.
7. Never disconnect or bypass any switch.
8. Carbon monoxide in the exhaust fumes can be fatal when inhaled, never operate a machine without proper ventilation.
9. Fuel is highly flammable, handle with care.
10. Keep engine clean. Allow the engine to cool before storing and always remove the ignition key.
11. Never use your hands to search for oil leaks. Hydraulic fluid under pressure can penetrate the skin and cause serious injury.
12. This machine demands your attention. To prevent loss of control or tipping of the vehicle:
 - A. Use extra caution in backing up the vehicle. Ensure area is clear.
 - B. Do not stop or start suddenly on any slope.
 - C. Reduce speed on slopes and in sharp turns. Use caution when changing directions on slopes.
 - D. Stay alert for holes in the terrain and other hidden hazards.
 - E. Run up and down slopes, never across the face.
13. Before leaving operator's position for any reason:
 - A. Disengage all drives.
 - B. Lower all attachments to the ground.
 - C. Shut engine off and remove the ignition key.
14. Keep hands, feet and clothing away from moving parts. Wait for all movement to stop before you clean, adjust or service the machine.
15. The rubber fingers, sweeper and vacuum pick up and propel debris and small objects in its path during operation. Keep the area of operation clear of all bystanders.
16. Never carry passengers.
17. Stop engine before making repairs/adjustments or checking/adding oil to the crankcase.
18. Use parts and materials supplied by SMITHCO only. Do not modify any function or part.
19. Do not remove the radiator cap when the engine is hot. When cooled, loosen cap slightly to the stop to relieve any pressure before removing the cap completely.
20. Avoid sharp turns. Watch the tires of the tractor while turning to make sure they do not contact the tongue of the Sweep Star V62.
21. Shut down power source before attempting to unclog any part of the machine.
22. If reel deck begins to vibrate abnormally, immediately shut off power and determine the cause.

These machines are intended for professional maintenance on golf courses, sports turf, and any other area maintained turf and related trails, paths and lots. No guaranty as to the suitability for any task is expressed or implied.



SPECIFICATIONS FOR SWEEP STAR V62

WEIGHTS AND DIMENSIONS

Length	151" (384 cm)
Width	68" (172 cm)
Height	87" (221 cm)
Weight	1500 lb (680 kg)

SOUND LEVEL

At ear level	98 dBA
At 30 ft (9.14m)	92.5 dBA

ENGINE

Make	Briggs & Stratton
Model#	543477
Type/Spec	0114E1
Horsepower	31 Hp (23 kW)
Fuel	Unleaded 87 Octane Gasoline Minimum
Cooling System	Air Cooled
Lubrication System	Full Pressure
Alternator	15 Amp

TIRES & WHEELS

Two 24 x 13.00 x 12 NHS (18 psi (1.3 bar))
Castor: 9 x 3.5 x 4 (20 psi (1.4 bar))

BATTERY (optional)

Automotive type 45- 12 volt	
BCI Group	Size 45
Cold Cranking Amps	480 minimum
Ground Terminal Polarity	Negative (-)
Maximum Length	9" (23 cm)
Maximum Width	5.38" (14 cm)
Maximum Height	9" (23 cm)

FLUID CAPACITY

Crankcase Oil	See Engine Manual
Fuel	5 gallon (19 liters)
Hydraulic Fluid	3.2 gallon (12.2 liters)
Cooling	2.8 quarts (2.7 liters)
Grade of Hydraulic Fluid	SAE 10W-40 API Service SJ or higher Motor Oil

OPTIONAL EQUIPMENT

78-201 Replacement Brush Reel	78-207 Hydraulic Lift System
78-202 Replacement Finger Reel	78-208 Filter System
78-203 Hard Surface Sweeper	78-209 Ball Hitch
78-204 5th Wheel Hitch	78-210 Nylon Brush Head
78-205 Remote Vacuum Hose	78-211 Rubber Finger Head
78-206 Clevis Hitch	78-073 Battery

SETUP

The Sweep Star V62 arrives from **SMITHCO** with some setup required.

1. Remove the top and sides from the shipping crate then remove the banding from the Sweeper.



Banding is under tension.

2. You will have to install the hitch onto your Sweep Star V62.
3. You will need a 22HP (minimum) tow vehicle with a 2600# minimum load capacity.
 - a. **Clevis Hitch** - You will need a $\frac{3}{4}$ " diameter by 4" pin with some type of lock.
 - b. **Ball Hitch** - You will need a 2" ball and a locking pin for the coupler.
 - c. **5th Wheel Hitch** - You will need the 5th wheel hitch mechanism mounted on your tow vehicle.
 - d. After the sweeper is hooked to the tow vehicle, you must raise the jack then turn it so that the foot of the jack is under the tongue of the sweeper.
4. Install castor wheels onto the brush/finger head assembly. You may put the machine bushings and spacers (A) on in any combination to get desired height. You should leave one machine bushing on the very bottom and one on the very top next to the lockpin.
5. Check the tire pressure. **Sweep Star V62:** 18 psi (1.3 bar) **Castor Wheels:** 20 psi (1.4 bar).
6. Install the battery. Battery box is located behind the hydraulic oil tank. This is a negative grounding system.

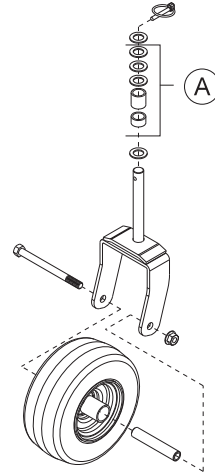

Connecting battery cables to the wrong post could result in personal injury and/or damage to the electrical system. Make sure battery and cables do not interfere or rub on any moving part. Connect the red positive(+) cable (A) to the battery first. When disconnecting remove the black negative(-) cable (B) first.

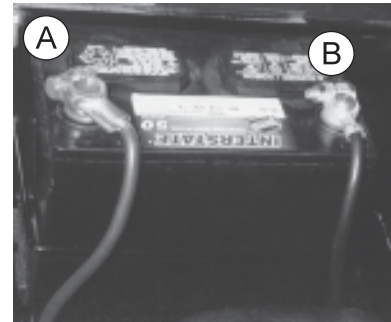

7. Check the engine oil and add as necessary. The dip stick is located on the right side, to the back of the engine. Oil fill is located on top of valve cover, use SAE 10W-40 API Service SJ or higher motor oil. **DO NOT OVERFILL.**
8. Check coolant level. Coolant tank is located on the left side of the engine.
9. Fill fuel tank, located on right side, with Unleaded 87 Octane gasoline (minimum).



Fuel is flammable. Caution must be used when storing or handling it. Do not fill fuel tank while engine is running or in an enclosed area. Fumes are explosive and dangerous to inhale. DO NOT SMOKE while filling the fuel tank. DO NOT OVERFILL.

10. Check hydraulic fluid level in tank. Remove cap and add SAE 10W-40 API Service SJ or higher motor oil if necessary. Fluid level should be about 2"-2 $\frac{1}{2}$ " (5 - 6.4 cm) from the top of the tank when cold.
11. Machine should be greased before starting. See Maintenance part of manual.
12. Read operating instructions before starting.

INSTALL HITCH - GENERAL

Use two people to install hitches.

1. Block both wheels so machine does not roll.
2. Use the jack (A) that is part of the sweeper to raise or lower sweeper to comfortable working height.
3. Slide the hitch (B) over the tabs on the front of the sweeper frame (C). Hitch must be on the outside. Use the four $\frac{1}{2}$ - 13 x $1\frac{1}{4}$ bolts (D) on the outside and four lock nuts on the inside. Tighten all four bolts.
4. See next pages on how to install the remaining parts of each individual hitch.

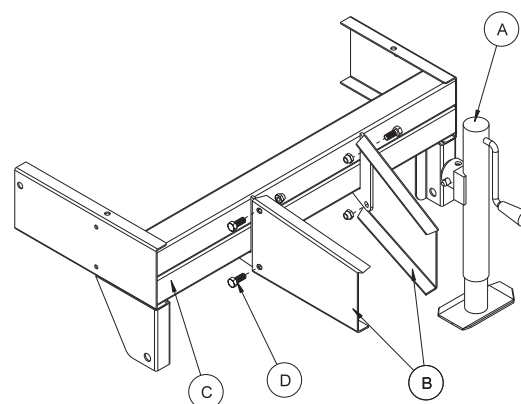

ADJUST HITCH HEIGHT - CLEVIS OR BALL HITCH

Have the sweeper on a level surface. Use the jack to raise or lower the front of the sweeper, so the tongue is 9" off the ground. Position the hitch insert (G) into the tongue; It has two holes, the first hole (F) is for making a longer tongue and the second hole (E) for a shorter tongue.

Note: The bolt in (E) is for reference only. There is only one bolt needed in the hitch insert.

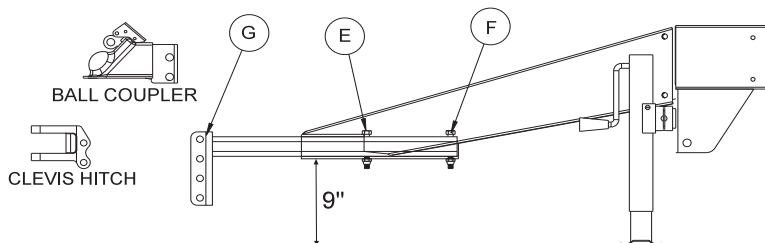

Back the towing vehicle up to the sweeper and using either the ball coupler or the clevis, check the height to the drawbar on the tow vehicle. The ball coupler or clevis can be adjusted by placing into different holes on the hitch insert (G). The hitch insert can also be turned over to provide more height options. The clevis can also be rotated 180° for more height options.

NOTE:

Do not tow on public roadways.

SETUP - BALL COUPLER AND CLEVIS HITCH

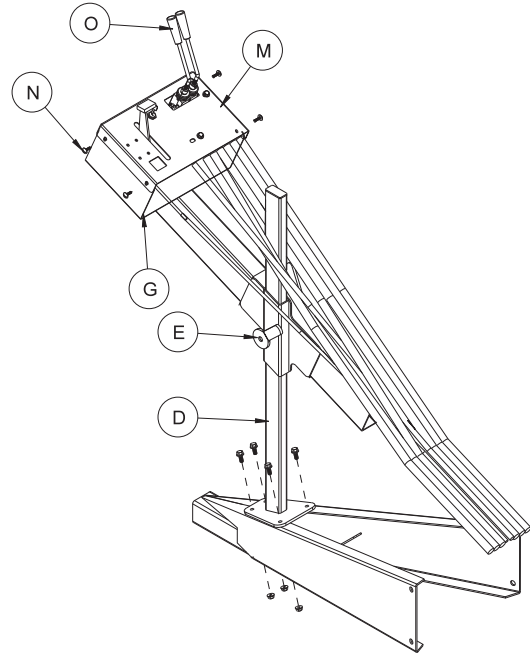
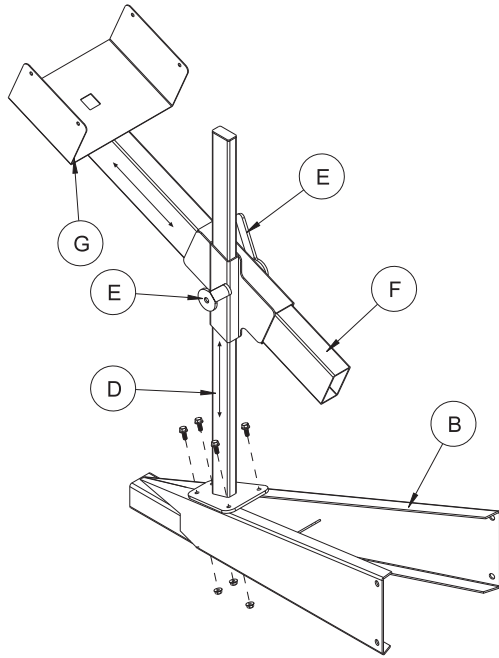

1. Install tongue (B) to main frame as explained on previous page.
2. Install adjustment slide (D) to tongue (B) using the four flange bolts $\frac{1}{4} - 20 \times \frac{3}{4}$ and four flange whiz lock nuts $\frac{1}{4} - 20$.
3. Loosen adjustment locks (E) on control panel adjustment (F) and put control panel adjustment (F) onto the adjustment slide (D).
4. Tighten one adjustment lock (E).
5. Slide the control panel mount (G) through the control panel adjustment (F) and tighten the other adjustment lock (E).
6. The control panel (M) has all the hoses, wiring and throttle cable connected to it and to the sweeper. The control panel is wrapped and fastened to the front of the sweeper.
7. Remove the control panel from the sweeper, bring it forward with the hoses to the rear and the throttle on the left hand side.
8. Fasten the control panel to the control panel mount (G) with the four truss head machine screws $\frac{1}{4} - 20 \times \frac{3}{4}$ (N) and four flange whiz lock nuts $\frac{1}{4} - 20$.
9. Put the two handles (O) onto the valve and tighten the lock nuts with the handles pointing forward.
10. Place three hoses and the throttle cable on the left hand side of the adjustment slide (D).

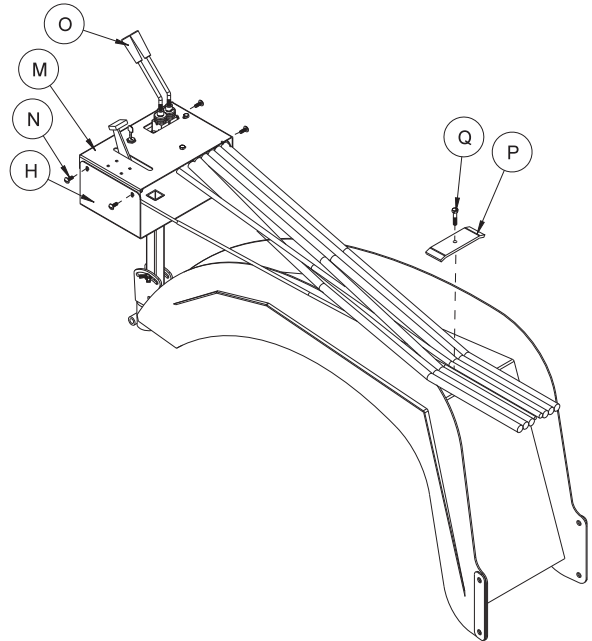
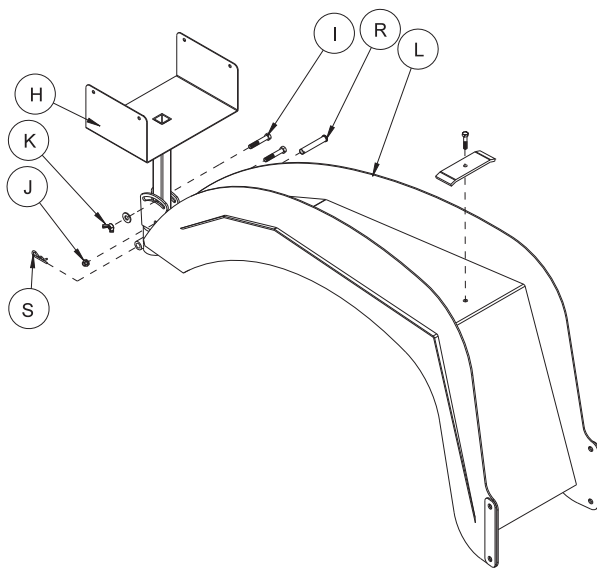

1. Install the gooseneck (tongue) (L) to main frame as explained on previous page.
2. Install the control panel mount (H) on the front of the gooseneck (L) as shown, using two $\frac{3}{8}$ - 16 x 2 $\frac{1}{4}$ bolts (I). On the bottom bolt use lock nut (J) and just tighten snug. On the top bolt use the $\frac{3}{8}$ washer and wing nut (K). Tighten both after adjusting for the proper position.
3. The control panel (M) has all hose, wiring and throttle cable connected to it and the sweeper. The control panel is wrapped and fastened to the front of the sweeper.
4. Remove the control panel from the sweeper, bring it forward with the hoses to the rear and the throttle on the left hand side.
5. Fasten the control panel to the control panel mount (H) with the four truss head machine screws $\frac{1}{4}$ - 20 x $\frac{3}{4}$ (N) and four flange whiz lock nuts $\frac{1}{4}$ - 20.
6. Put the two handles (O) onto the valve and tighten the lock nuts with the handles pointing forward.
7. Lay the hoses, wiring and throttle cable on top of the gooseneck and place the hose hold-down (P) over the top. At the rear most hole on top of the gooseneck (L) fasten the hose hold-down with $\frac{5}{16}$ - 18 x 1 $\frac{1}{2}$ bolt and lock nut.
8. To connect to tow vehicle, remove the $\frac{1}{2}$ x 3 clevis pin (R) and $\frac{1}{8}$ bridge pin (S). Place gooseneck over ball on 5th wheel hitch and then replace clevis pin and bridge pin.

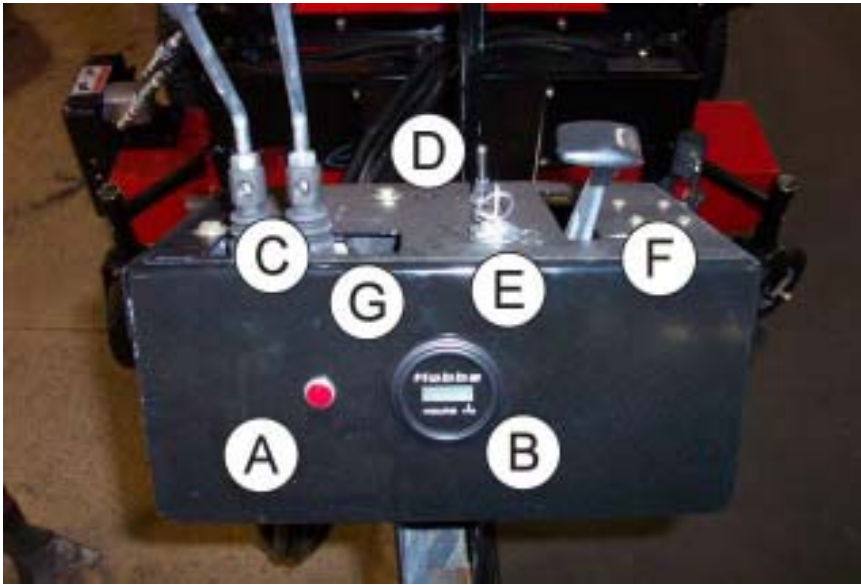

- A. **Oil Light** - The oil light should come on when ignition is on without engine running. The oil light will light when the oil pressure is low. If oil light should come on, shut off engine immediately and find the cause.
- B. **Hour Meter** - The hour meter indicates hours of machine operation. The hour meter operates when ignition switch is on.
- C. **Tailgate Lever** - The tailgate lever is used to open and close the tailgate. Refer to decal for direction.
- D. **Reel Off-On Valve** - Turns the reel on or off. Refer to decal for direction.
- E. **Ignition Switch** - The ignition switch has three positions: Off - Run - Start.
- F. **Hand Throttle** - The hand throttle is used to regulate engine speed.
- G. **Reel Lift Lever** - The reel lift lever is used to raise and lower the reel. Refer to decal for direction. (Optional)

Before operating this machine, become familiar with all controls and functions of this unit and the tow vehicle. Also complete all maintenance requirements and read all safety warnings. By knowing both machines thoroughly, how it operates and by doing the prescribed maintenance steps, you can expect relatively trouble-free operation for years to come.

TOWVEHICLE

You will need a 22HP minimum tow vehicle, with a 2600 lb. minimum load capacity.

1. **Clevis Hitch** - You will need a $\frac{3}{4}$ " diameter by 4" pin with some type of lock.
2. **Ball Hitch** - You will need a 2" ball and a locking pin for the coupler.
3. **5th Wheel Hitch** - You will need the 5th wheel hitch mechanism mounted on your tow vehicle.
4. After the sweeper is hooked to the tow vehicle, you must raise the jack then turn it so that the foot of the jack is under the tongue of the sweeper.

DAILY CHECKLIST

1. Check engine oil level. Add as needed. **DO NOT OVERFILL.**
2. Tire pressure should be 18 psi (1.3 bar) on Sweep Star V62 tires and 20 psi (1.4 bar) on castor wheels.
3. Inspect electrical system for loose connections or frayed wiring, including battery cables. Replace any faulty equipment or tighten if loose.
4. Check hardware for loose or missing nuts, bolts, screws, etc., and tighten or replace as needed.
5. Inspect hydraulic lines for damage or leaks. Never use hands to inspect leaks.
6. Check hydraulic oil level in right side tank. The level should be 2" to 2 $\frac{1}{2}$ " (5-6.4 cm) from top of tank when fluid is cold. If level is low, add SAE 10W-40 API Service SJ or higher motor oil.
7. Check controls for smooth, proper working operation. Lubricate as needed.
8. Check and clean all debris from engine compartment.
9. Check coolant tank level. Fill as needed.

STARTING ENGINE

1. Make sure the fuel flow valve, located on the fuel tank, is "ON."
2. The ignition switch is located on remote operator control panel. Insert key (A) and turn clockwise until engine starts (C). Release key and it will return to run position (B). Use choke and hand throttle as necessary.
3. Allow engine to idle and warm up a few minutes.
4. Be sure the jack is all the way up and will clear all ground obstacles.

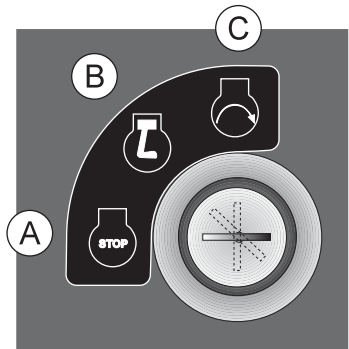

ADJUSTMENT OF BELT TENSIONER

There are two belt tensioners on the Sweep Star V62. One controls the tension on the belt from the engine to blower shaft the other controls the belt on the finger or brush reel. The proper tension of the idler should be 12 to 15 as per the gauge (A) on the side of the tightener. Over tightening the belt will shorten the life of the belt and the machine may not perform to the best of its ability. To adjust belt tensioner, loosen bolt holding tensioner. Bring idler pulley tight to belts and turn tensioner into belts to 15°. Tighten holder bolt.

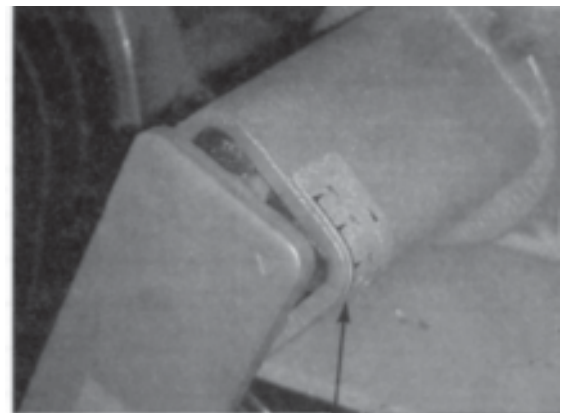

OPERATION

DECK LIFT ARMS

1. The deck lift arms (D) are located on the right and left sides of the main frame above the reel housing.
2. The up position (A) is used in transport.
3. The lower position (B) is used when reel is being used.
4. To lower the deck, grab deck lift handle (D) and lift up and away from the machine. Lower handle to the bottom of the slot (B).
5. To raise the deck, lift the deck lift handles (D) all the way up and push in towards machine to rest in notch (A).
6. The jack (C) must be put in the up position whenever the machine is in motion. Pull the lockpin (E) and rotate the jack towards the machine. Replace lockpin.

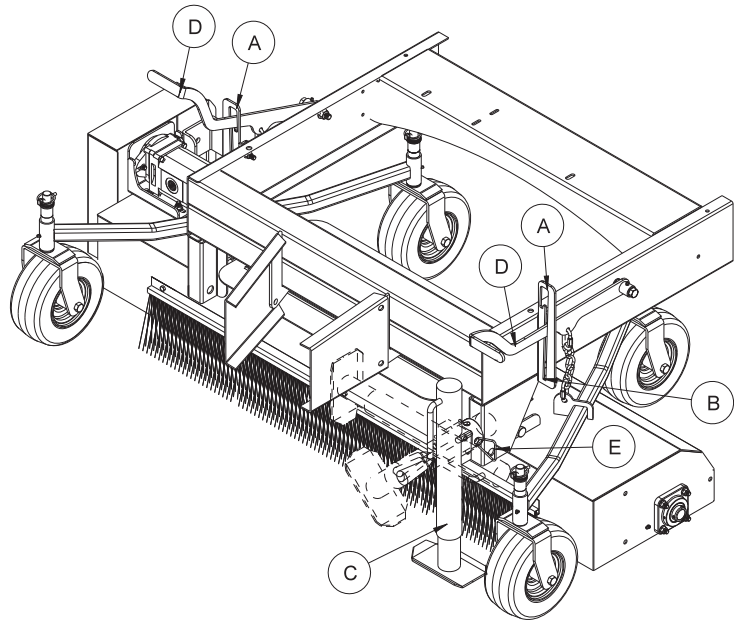

OVERLOADING DEBRIS HOPPER AND WEAR ON VACUUM HOUSING

OVERLOADING DEBRIS HOPPER

Smithco Sweeper-Vacs are designed to carry the following maximum loads:

Model 78-200 & 78-500 Sweep Star V62 860 lbs. (400 kg)

PLEASE NOTE THE FOLLOWING:

1. Loads heavier than that will damage the unit.
2. Such damage is not covered by warranty.
3. Overloading is particularly easy when collecting aerifier cores.
4. The hoppers on the Big Vac and V62 are large in order to hold 7 and 4 cubic yards respectively, of thatch, grass clippings, leaves and trash.
5. They will not hold 7 or 4 cubic yards of aerifier cores.
6. The maximum depth (in the debris hopper) of aerifier cores is:

Model 78-200 & 78-500 Sweep Star V62 40 in. (101 cm)

VACUUM HOUSING WEAR

The Big Vac & V62 are fitted with a wear resistant liner in the vacuum housing. This will provide additional housing life. Be sure the following points are explained to the user:

1. The vacuum housing and impeller must be cleaned each time the unit is used so the housing liner is inspected daily. Only Smithco Sweeper-Vacs provide a clean out/inspection port for easy inspection and cleaning.
2. When bare steel is visible at any point in the housing lining, the lining must be replaced. It is expected the liner will wear and be replaced. It is a vast improvement over competitive units with no liners.
3. Replacement of the liner or the vacuum housing due to wear is normal and is not covered by warranty.
4. Collection of aerifier cores causes extreme wear on the liner (and if unchecked, on the housing).
5. Caution users that, while Smithco Sweeper-Vacs do an excellent job collecting cores, the lining (and the housing) will wear quickly in such use.

RUBBERIZED BOOT

The rubberized boot between main unit and sweeper head is subject to wear and damage from debris. Unless defective, replacement of this boot is not covered by warranty.

BATTERY

Batteries normally produce explosive gases which can cause personal injury. Do not allow flames, sparks or any ignited object to come near the battery. When charging or working near battery, always shield your eyes and always provide proper ventilation.

Battery cable should be disconnected before using "Fast Charge".

Charge battery at 15 amps for 10 minutes or 7 amps for 30 minutes. Do not exceed the recommended charging rate. If electrolyte starts boiling over, decrease charging.

Always remove grounded (-) battery clamp first and replace it last. Avoid hazards by:

1. Filling batteries in well-ventilated areas.
2. Wear eye protection and rubber gloves.
3. Avoid breathing fumes when electrolyte is added.
4. Avoid spilling or dripping electrolyte.



Battery Electrolyte is an acidic solution and should be handled with care. If electrolyte is splashed on any part of your body, flush all contact areas immediately with liberal amounts of water. Get medical attention immediately.

JUMPSTARTING



Use of booster battery and jumper cables. Particular care should be used when connecting a booster battery. Use proper polarity in order to prevent sparks.

To jump start (negative grounded battery):

1. Shield eyes.
2. Connect ends of one cable to positive (+) terminals of each battery, first (A) then (B).
3. Connect one end of other cable to negative (-) terminal of "good" battery (C).
4. Connect other end of cable (D) to engine block on unit being started (NOT to negative (-) terminal of battery)

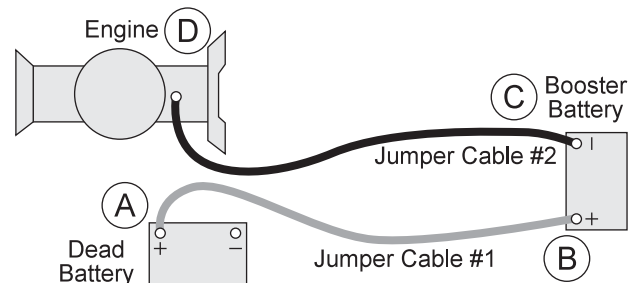

To prevent damage to other electrical components on unit being started, make certain that engine is at idle speed before disconnecting jumper cables.

WIRING DRAWING

Diagrams

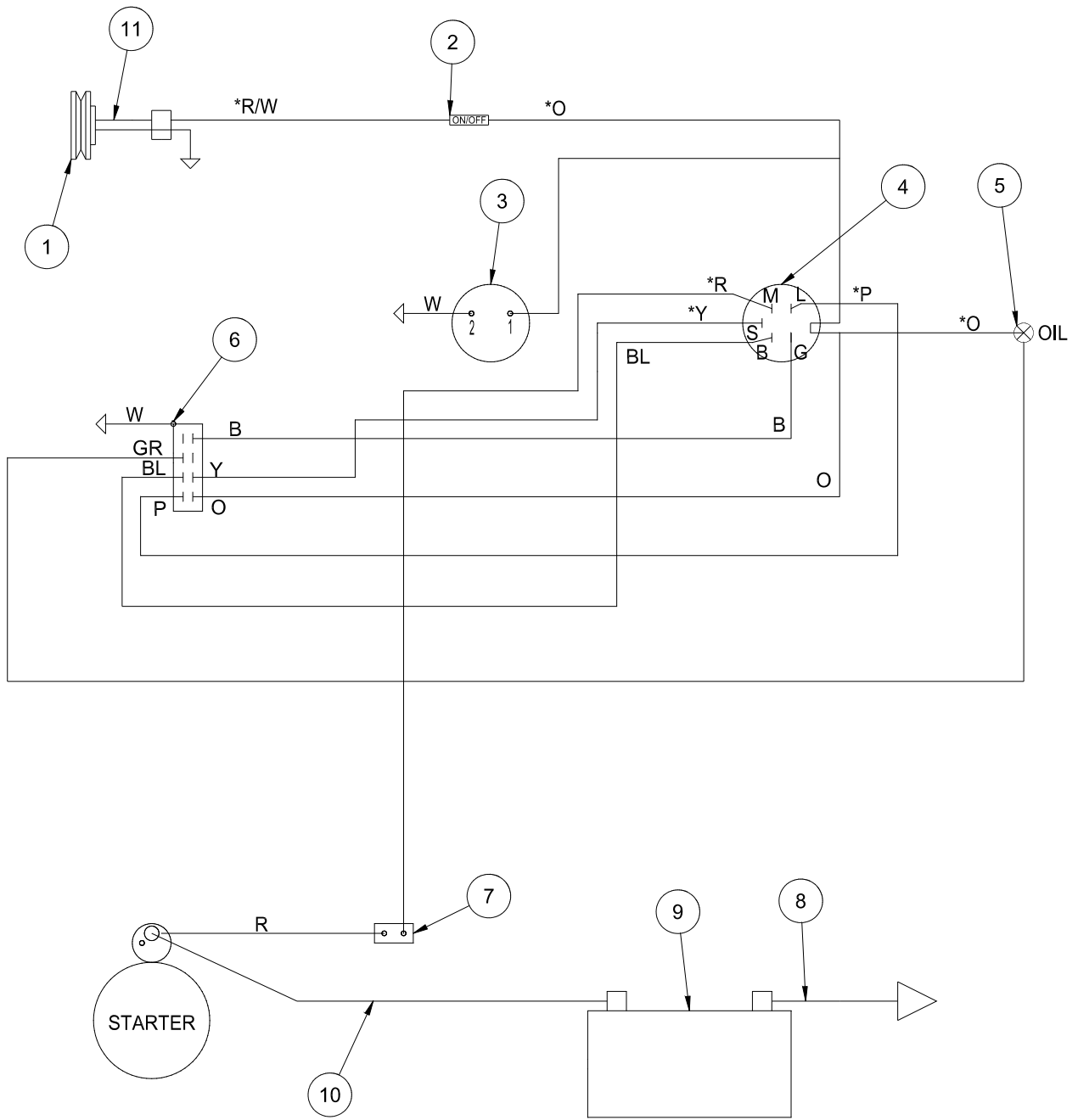

WIRING PARTSLIST

REF#	PART#	DESCRIPTION	QUANTITY
1	78-368	Electric Clutch	1
2	15-314	Toggle Switch	1
	15-472	Switch Boot	1
3	12-017	Hour Meter	1
4	13-488	Ignition Switch	1
5	50-359	Oil Light	1
	8874	Female Bullet Connector	1
	8875	Male Bullet Connector	1
	8963	Heat Shrink	2
6		Plug on Engine	1
7	8975	30 Amp Circuit Breaker	1
	8977	Circuit Breaker Boot	1
8	22-054	Battery Cable Black	1
9	22-073	Battery (optional)	1
10	78-325	Red Battery Cable with Boot	1
	78-442	Wire Harness (includes all wire colors with *)	

HYDRAULIC PARTSLIST

REF#	PART#	DESCRIPTION	QUANTITY
1	78-247	Hydraulic Hose (brush motor to valve)	2
2	78-220	Hydraulic Pump	1
3	23-006	Oil Filter	1
	23-031	Filter Element (replacement only)	1
4	78-249	Hydraulic Hose (pump to valve)	1
5	78-250	Hydraulic Hose (return to tank)	1
6	78-415	2-Bank Valve	1
7	78-248	Hydraulic Hose (front hyd. cyl. to rear valve)	1
8	78-246	Hydraulic Hose (rear hyd. cyl. to front valve)	1
9	13-584	Oil Tank	1
10	8917-12.75	Suction Hose $\frac{5}{8}$ ID x $12\frac{3}{4}$	1
	18-040	Hose Clamp	2
11	78-251	Hydraulic Hose (case drain hyd. motor to tank)	1
12	78-219	Hydraulic Motor	1
13	78-225	Hydraulic Cylinder	1

HYDRAULIC PRESSURES

Pump Displacement	.4 in ³ /rev
Pump Input Speed (up to)	3600 rpm
Max. Operating Pressure	2500 psi
Max. Inlet Vacuum	10 in. Hg
Max. Case Pressure	80 psi
78-306 Hydraulic Valve (2 bank)	2500 psi

EC Declaration of Incorporation

In accordance with EN ISO 17050-1:2004

We

Smithco Inc.
34 West Avenue
Wayne, PA USA
19087-3311

In accordance with the following Directive:

2006/42/EC

The Machinery Directive

hereby declare that for the partly completed machinery identified as :

Equipment Sweep Star V62
Model number 78-200
Serial Number 78439 and up

the following EHSRs have been complied with:

BS EN ISO 12100-1:2003	Safety of Machinery Part 1
BS EN ISO 12100-2:2003	Safety of Machinery Part 2
BS EN ISO 13857	Safety of Machinery upper and lower limbs
BS EN 349: 1993+A1:2008	Safety of Machinery Crushing hazards

and the technical documentation is compiled in accordance with Annex VII(B) of the Directive.

We undertake to transmit, in response to a reasoned request by the appropriate national authorities, relevant information on the partly completed machinery identified above. The method of transmission shall be electronically

The machinery is incomplete and must not be put into service until the machinery into which it is to be incorporated has been declared in conformity with the provisions of the Directive.

Signed by:



Dawn Bryngelson
Technical Documentation Advisor
Smithco West Inc.
200 West Poplar Avenue
Cameron, WI 54822 USA
24-Feb -10

The technical documentation for the machinery is available from:



Tim Lansdell
Technical Director
19th March 2009
Ransomes Jacobsen Limited
West Road, Ransomes Europark, Ipswich,
England, IP3 9TT

The Smithco Commercial Products Two-Year Limited Warranty

Smithco, Inc. (Smithco) warrants your 2007 or newer Smithco Commercial Product (“Product”) purchased after January 1, 2007, to be free from defects in materials or workmanship for the period of time listed below. Where a warrantable condition exists, Smithco will repair the Product at no cost to you including diagnosis, labor (at the Smithco standard labor rate, subject to the Smithco flat rate schedule), and parts.

Warranty Duration is:

- (1) **Two years, 1500 operational hours* from the date of delivery to the original purchaser or three years from the date of original manufacturer of the product, whichever occurs first. (*Products equipped with hour meter).**
- (2) **Products used in rental situations are covered for 90 days from date of delivery to original user/renter.**

Owner Responsibilities:

As the Product owner, you are responsible for required maintenance and adjustments stated in your Owner’s Manual. Failure to perform required maintenance and adjustments can be grounds for disallowing a warranty claim. **You are particularly responsible to train all present and future operators of this product on the safe operation of this product at your location.**

Instructions for Obtaining Warranty Service:

You are responsible for notifying the Authorized Smithco Products Distributor from whom you purchased the Product as soon as you believe a warrantable condition exists and not later than 30 days from discovery of the condition.

If you need help locating an Authorized Smithco Distributor, or if you have questions regarding your warranty rights or responsibilities, you may contact us at:

Smithco Product Support Department
200 W Poplar PO Box 487
Cameron, Wisconsin 54822

Telephone: 1-800-891-9435 E-Mail: ProductSupport@smithco.com

Maintenance Parts:

Parts scheduled for replacement as required maintenance (“Maintenance Parts”), are warranted for the period of time up to the scheduled replacement time for that part.

Items/Conditions Not Covered:



Not all product failures or malfunctions that occur during the warranty period are defects in materials or workman-ship. The items/conditions listed below are not covered by this warranty:



Product failures which result from the use of non-Smithco replacement parts, or from installation and use of add-on, modified, or unapproved accessories are not cov-ered.



Product failures which result from failure to perform required maintenance and/or adjustments are not covered.



Product failures that result from operating the Product in an abusive, negligent or reckless manner are not covered.



This warranty does not apply to parts subject to con-sumption through use, unless found to be defective. Examples of parts which are consumed, or used up, during normal Product operation include, but are not limited to: blades, tines, teeth, scarifiers, rakes, plates, wear plates, castor wheels, tires, batteries, filters, belts, nozzles, etc.



This warranty does not apply to failures caused by out-side influence. Items considered to be outside influ-ence include, but are not limited to, weather, storage practices, contamination, use of unapproved coolants, lubricants, additives, or chemicals, etc.



This warranty does not apply to normal “wear and tear” items. Normal “Wear and Tear” includes, but is not limited to, damage to seats due to wear or abrasion, worn painted surfaces, scratched decals or windows, etc.



Smithco may require the return of failed parts or components in order to determine the validity of any warranty claim.



Smithco will not be obligated to replace components of other manufacturers if inspection by the original component manufacturer indicates that failure was due to normal wear and tear, expected consumption through use or improper care or service.

Other Legal Disclaimers:

The above remedy for product defects through repair or replacement by an authorized Smithco distributor or dealer is the purchaser’s sole remedy for any defect. This warranty gives you specific legal rights, and you may also have other rights which vary from state to state.

THERE ARE NO OTHER EXPRESS WARRANTIES OTHER THAN THOSE SET FORTH ABOVE. ALL IMPLIED WARRANTIES OF MERCHANTABILITY AND FITNESS FOR USE ARE LIMITED TO THE DURATION OF THE LIMITED WARRANTIES CONTAINED HEREIN.

Some states may not allow limitations on how long an implied warranty lasts, so the above limitation may not apply to you.

THE SMITHCO COMPANY IS NOT LIABLE FOR INDIRECT, INCIDENTAL OR CONSEQUENTIAL DAMAGES IN CONNECTION WITH THE USE OF THE PRODUCT, INCLUDING ANY COST OR EXPENSE OF PROVIDING A SUBSTITUTE PRODUCT OR SERVICE DURING PERIODS OF MALFUNCTION OR NON-USE.

Some states may not allow the exclusion of indirect, incidental or consequential damages, so the above exclusion may not apply to you.

Smithco neither assumes, nor authorizes any person to assume for it, any other liability in connection with the sale or use of this product.

SMITHCO, INC.

Wayne, PA 19087

