

Operator's



Big Vac Engine Drive

73-000-B

SN: 73045

October 2010

Product Support:

Hwy 55 & Poplar Ave; Cameron WI 54822

1-800-891-9435 productsupport@smithco.com

CONTENTS

Introduction

Service

Diagrams

Parts

Accessories

Reference

Introduction	1-11
Introduction	1
Symbols	2-3
Safe Practices	4
Specifications	5
Optional Equipment	5
Setup	6-7
Controls & Instruments	8
Operation	9
Battery	10
Overloading Debris Hopper and Vacuum Housing Wear	11
Diagrams	12-15
Wiring Drawing	12-13
Hydraulic Drawing	14-15
Other	16
Declaration of Conformity-English	
Warranty	

Thank you for purchasing a **SMITHCO** product.

Read this manual and all other manuals pertaining to the Big Vac V72-E carefully as they contain safety, operating, assembly and maintenance instructions. Failure to do so could result in personal injury or equipment damage.

Keep manuals in a safe place after operator and maintenance personnel have read them. Right and left sides are from the operator's seat, facing forward.

All **SMITHCO** machines have a Serial Number and Model Number. Both numbers are needed when ordering parts. The serial number plate on the Big Vac is located on the front cross member of the frame.

For easy access record your Serial and Model numbers here.

SMITHCO			CE
WAYNE, PENNSYLVANIA 19087 USA 610-688-4009 Fax 610-688-6069			
SERIAL NO.	kW/hp	DATE OF MFG.	
<input type="text"/>	<input type="text"/>	<input type="text"/>	
MODEL NO.	lb/kg Empty	lb/kg Full	
<input type="text"/>	<input type="text"/>	<input type="text"/>	

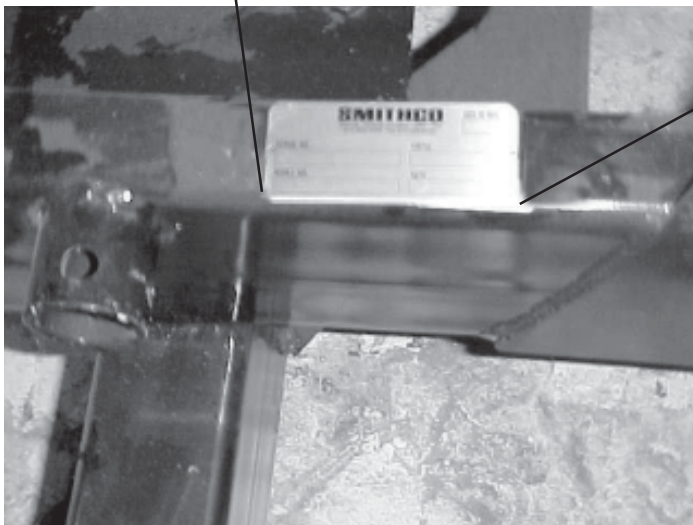

Information needed when ordering replacement parts:

1. Model Number of machine
2. Serial Number of machine
3. Name and Part Number of part
4. Quantity of parts

SYMBOLS

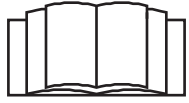

Read Operator's Manual



Electrical Power



No Electrical Power



Engine - Stop



Engine - Start



Engine - Run

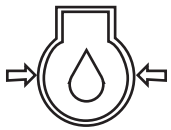

Engine Oil

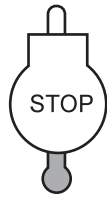

Temperature Light

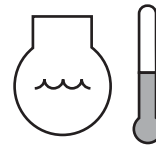

Water Temperature

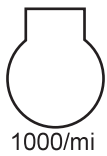

RPM

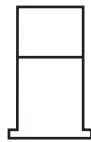

Gasoline



Diesel



Glow Plug - On



Glow Plug - Off



Glow Plug



Hour Meter

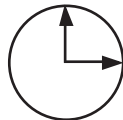

Hour Meter

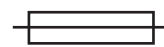

Fuse



Hand Throttle



Choke - Closed



Choke - Open



Park Brake



Park Brake Release

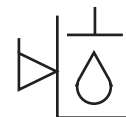











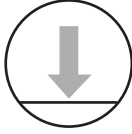

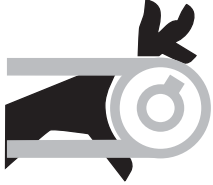
Hydraulic Oil Level

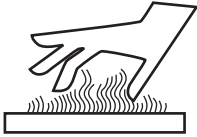
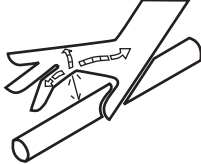
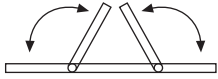
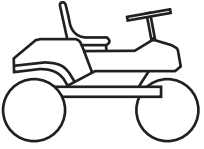
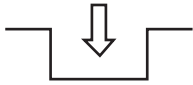

Off / Stop

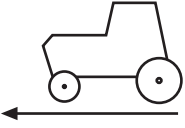

On / Start

	Up/Down Arrow		Down/Lower		Up/Raise
	No Smoking		Moving Parts		Manual Operation
	Pinch Point		Step		Hot Surface
	Hydraulic Fluid Penetration		Lift Arm		Tractor
	Engage		Disengage		PTO
	Ground Speed		Fast		Slow
H	High	L	Low	F	Forward
R	Reverse	N	Neutral		Warning Danger Caution

SAFE PRACTICES

1. It is your responsibility to read this manual and all publications associated with this machine (engine, accessories and attachments).
2. Never allow anyone to operate or service the machine or its attachments without proper training and instructions. Never allow minors to operate any equipment.
3. Learn the proper use of the machine, the location and purpose of all the controls and gauges before you operate the equipment. Working with unfamiliar equipment can lead to accidents.
4. Wear all the necessary Personal Protective Equipment (PPE) on your head, eyes, ears, hands and feet. **Ear and eye protection are required.** Operate the machine only in daylight or in good artificial light.
5. Inspect the area where the equipment will be used. Beware of overhead obstructions and underground obstacles. Stay alert for hidden hazards.
6. Never operate equipment that is not in perfect working order or without decals, guards, shields, or other protective devices in place.
7. Never disconnect or bypass any switch.
8. Carbon monoxide in the exhaust fumes can be fatal when inhaled, never operate a machine without proper ventilation.
9. Never use your hands to search for oil leaks. Hydraulic fluid under pressure can penetrate the skin and cause serious injury.
10. This machine demands your attention. To prevent loss of control or tipping of the vehicle:
 - A. Use extra caution in backing up the vehicle. Ensure area is clear.
 - B. Do not stop or start suddenly on any slope.
 - C. Reduce speed on slopes and in sharp turns. Use caution when changing directions on slopes.
 - D. Stay alert for holes in the terrain and other hidden hazards.
 - E. Operate equipment up and down slopes, never across the face.
11. Before leaving operator's position for any reason:
 - A. Disengage all drives.
 - B. Lower all attachments to the ground.
 - C. Shut engine off and remove the ignition key.
12. Keep hands, feet and clothing away from moving parts. Wait for all movement to stop before you clean, adjust or service the machine.
13. The rubber fingers, sweeper and vacuum pick up and propel debris and small objects in the machines path during operation. Keep the area of operation clear of all bystanders.
14. Never carry passengers.
15. Use parts and materials supplied by SMITHCO only. Do not modify any function or part.
16. Avoid sharp turns. Watch the tires of the tractor while turning to make sure they do not contact the tongue of the Big Vac.
17. Shut down power source before attempting to unclog any part of the machine.
18. If reel deck and/or blower began to vibrate abnormally, immediately shut off power and determine the cause.

These machines are intended for professional maintenance on golf courses, sports turf, and any other area maintained turf and related trails, paths and lots. No guaranty as to the suitability for any task is expressed or implied.

SPECIFICATIONS FOR BIG VAC ENGINE DRIVE

WEIGHTS AND DIMENSIONS

Length	180" (458 cm)
Width	84" (214 cm)
Height	87" (221 cm)
Weight	2950 lb (1338 kg)

SOUND LEVEL

At ear level	98 dBA
At 30 ft (9.14 m)	92.5 dBA

ENGINE

Make	Briggs & Stratton
Model#	543477
Type/Spec	0175G1
Horsepower	31 Hp (23 kW)
Fuel	Unleaded 87 Octane Gasoline Minimum
Cooling System	Air Cooled
Lubrication System	Full Pressure
Alternator	20 Amp

TIRES & WHEELS

Two 26.5 - 1400 x 12 NHS (18 psi (1.3 bar)) Fairway Type Turf Tires
Castor: 13 x 5 x 6 (20 psi (1.4 bar))

BATTERY (optional)

Automotive type	45 - 12 volt
BCI Group	Size 45
Cold Cranking Amps	480 minimum
Ground Terminal Polarity	Negative (-)
Maximum Length	9" (23 cm)
Maximum Width	5.38" (14 cm)
Maximum Height	9" (23 cm)

FLUID CAPACITY

Crankcase Oil	See Engine Manual
Fuel	6 gallon (22.7 liters)
Hydraulic Fluid	3.2 gallon (12.2 liters)
Grade of Hydraulic Fluid	SAE 10W-40 API Service SJ or higher Motor Oil

OPTIONAL EQUIPMENT

72-002 Rubber Finger Sweeper Head	73-003 Standard Clevis Hitch
72-005 Nylon Brush Head	73-004 5th Wheel Hitch for Tractor w/ Electric brakes
72-006 Replacement Brush Reel	73-005 5th Wheel for Tractor
22-073 Battery	73-006 Vacuum Hose Hand Held

SETUP

The Big Vac V72-E arrives from **SMITHCO** with some setup required.

1. You will need a 40 HP (minimum) tow vehicle to remove the Big Vac V72-E from the trailer.
 - a. **Clevis Hitch** - You will need a $\frac{3}{4}$ " diameter by 4" pin with some type of lock.
 - b. **3-Point Ball Hitch (optional)** - You will need a 2" ball and a locking pin for the coupler.
2. Crank the jack on the Big Vac V72-E up so you can hook to tow vehicle.
3. Check the tire pressure. **Big Vac V72-E:** 18 psi (1.3 bar) **Castor Wheels:** 20 psi (1.4 bar).
4. Check hydraulic fluid level in tank. Look at the sight gauge on the front left side of the tank. The oil level should be at 90°C (194°F). If level is low, add SAE 10W-40 API Service SJ or higher motor oil.
5. Machine should be greased before starting. See Maintenance part of manual.
6. Lower reel all the way down. Place rubber boot onto the bottom of the blower housing. Raise the reel up $\frac{3}{4}$ of the way. Stretch rubber boot around lip on reel. Lift and lower several times to ensure boot is on properly.
7. Read operating instructions before starting.



Connecting battery cables to the wrong post could result in personal injury and/or damage to the electrical system. Make sure battery and cables do not interfere or rub on any moving part. Connect the red positive(+) cable (A) to the battery first. When disconnecting remove the black negative(-) cable (B) first.



7. Check the engine oil and add as necessary. The dip stick is located on the right side, to the back of the engine. Oil fill is located on top of valve cover, use SAE 10W-40 API Service SJ or higher motor oil. **DO NOT OVERFILL.**
8. Check coolant level. Coolant tank is located on the left side of the engine.
9. Fill fuel tank, located on right side, with Unleaded 87 Octane gasoline (minimum).



Fuel is flammable. Caution must be used when storing or handling it. Do not fill fuel tank while engine is running or in an enclosed area. Fumes are explosive and dangerous to inhale. DO NOT SMOKE while filling the fuel tank. DO NOT OVERFILL.

10. Check hydraulic fluid level in tank. Remove cap and add SAE 10W-40 API Service SJ or higher motor oil if necessary. Fluid level should be about 2"-2 $\frac{1}{2}$ " (5 - 6.4 cm) from the top of the tank when cold.
11. Machine should be greased before starting. See Maintenance part of manual.
12. Read operating instructions before starting.

Before servicing or making adjustments to machine, stop engine on tow vehicle and remove key from ignition.

NOTE: Use all procedures and parts prescribed by the manufacturer's. Read the engine manual before operation.

LUBRICATION

Use No. 2 General Purpose Lithium Base Grease and lubricate **DAILY**. The Big Vac has 13 grease fittings. All bearings are sealed bearings. When inserting grease, be careful not to ruin the seal, if this happens, replace the bearing at once. Be sure to wipe grease fitting clean before injecting grease. Give only one or two pumps of grease at each lubrication.

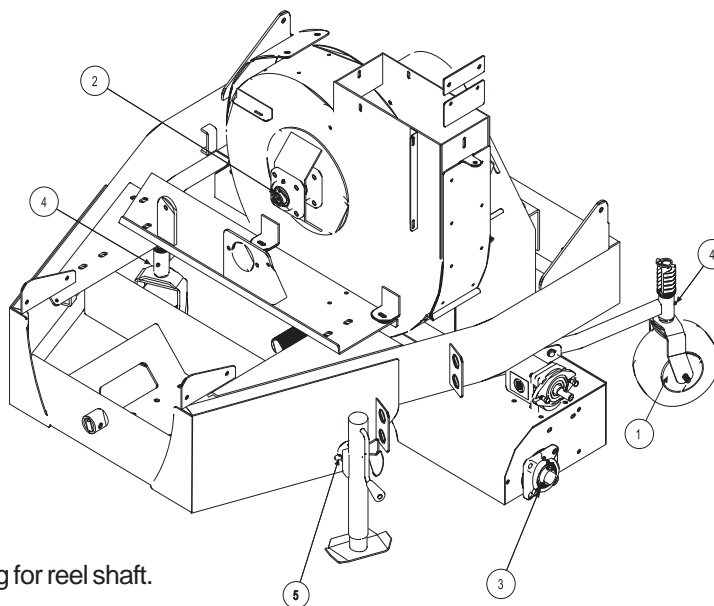

REF#	LOCATION
1	One on all four castor wheels.
2	Two on the fan shaft.
3	One on each mounted bearing for reel shaft.
4	One on all four castor wheel mount brackets.
5	One on the jack stand.

HYDRAULIC OIL

1. Use SAE 10W-40 API Service SJ or higher motor oil.
2. For proper warranty, change oil every 500 hours or annually, which ever is first and change the filter after the first 20 hours, then at 100 hours, then every 250 hours thereafter.
3. Inspect hydraulic lines for damage or leaks. Never use hands to inspect leaks.
4. Check hydraulic fluid level in tank. Look at the sight gauge on the front left side of the tank. The oil level should be at 90°C (194°F). If level is low, add SAE 10W-40 API Service SJ or higher motor oil.
5. After changing oil and/or filter, operate the machine for a few minutes. Check oil level and for leaks.
6. Always use caution when filling hydraulic oil tank or checking level to keep system free of contaminants. Check and service more frequently when operating in extremely cold, hot or dusty conditions.
7. If natural color of fluid is now black or smells burnt, it is possible that an overheating problem exists.
8. If fluid becomes milky, water contamination may be a problem.
9. If either of the above conditions happen, change oil and filter immediately after fluid is cool and find cause. Take fluid level readings when system is cold.
10. In extreme temperatures you can use straight weight oil. We recommend SAE 30W API Service SJ or higher when hot (above 90°F (33°C)) and SAE 10W API Service SJ or higher when cold (below 32°F (0°C)) ambient temperature. Use either motor oil or hydraulic oil, but do not mix.
11. Oil being added to the system must be the same as what is already in the tank. Mark tank fill area as to which type you put in.

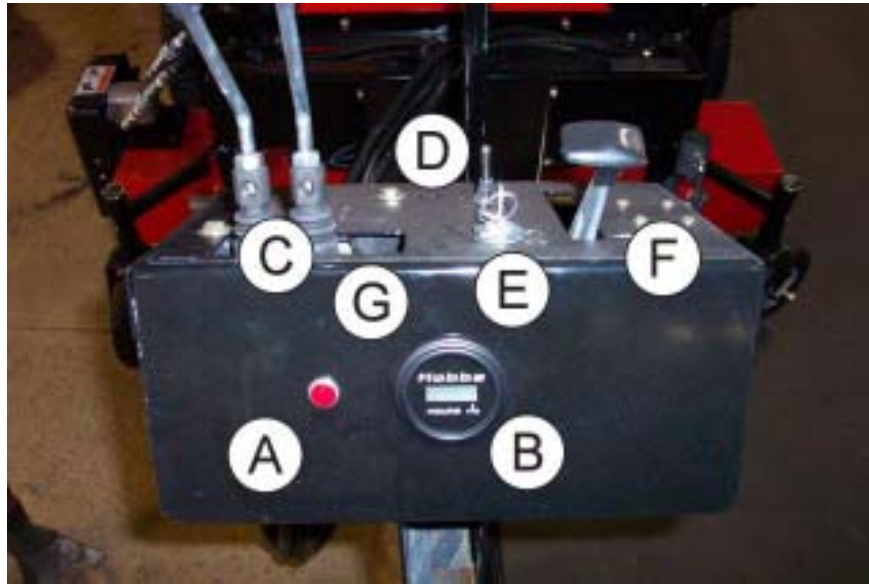

- A. **Oil Light** - The oil light should come on when ignition is on without engine running. The oil light will light when the oil pressure is low. If oil light should come on, shut off engine immediately and find the cause.
- B. **Hour Meter** - The hour meter indicates hours of machine operation. The hour meter operates when ignition switch is on.
- C. **Tailgate Lever** - The tailgate lever is used to open and close the tailgate. Refer to decal for direction.
- D. **Reel Off-On Valve** - Turns the reel on or off. Refer to decal for direction.
- E. **Ignition Switch** - The ignition switch has three positions: Off - Run - Start.
- F. **Hand Throttle** - The hand throttle is used to regulate engine speed.
- G. **Reel Lift Lever** - The reel lift lever is used to raise and lower the reel. Refer to decal for direction. (Optional)

HOPPER LIFT SAFETY

The Hopper Lift Safety is used to support the ram on the hopper bottom in the extended position so you may service or repair the machine under the hopper. When not in use the Hopper Lift Safety can be stored on the hopper bed frame.

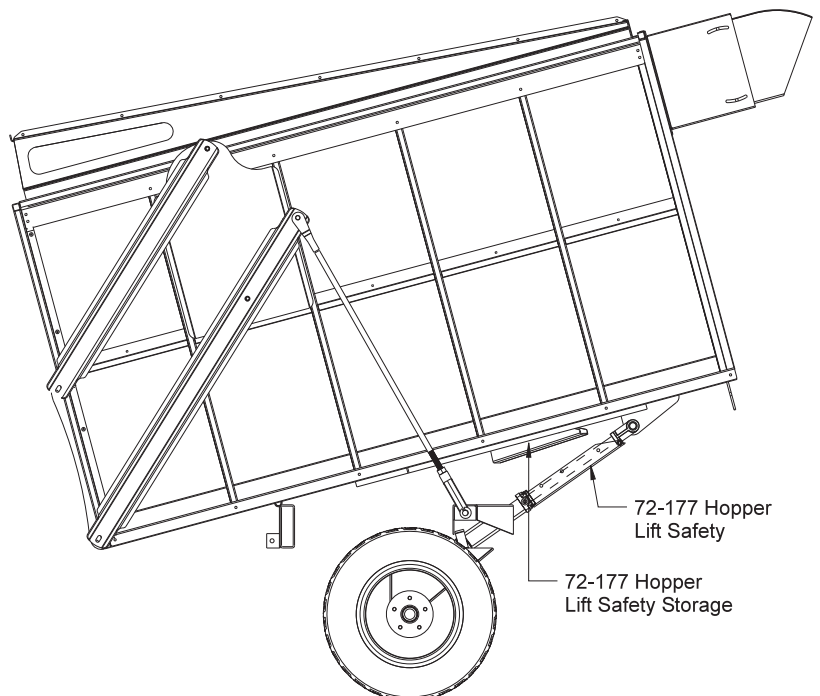

Before operating this machine, become familiar with all controls and functions of this unit and the tow vehicle. Also complete all maintenance requirements and read all safety warnings. By knowing both machines thoroughly, how it operates and by doing the prescribed maintenance steps, you can expect relatively trouble-free operation for years to come.

TOWVEHICLE

You will need a 40 HP minimum tow vehicle.

1. **Clevis Hitch** - You will need a $\frac{3}{4}$ " diameter by 4" pin with some type of lock.
2. **3-Point Ball Hitch** - You will need a 2" ball and a locking pin for the coupler.

DAILYCHECKLIST

1. Check engine oil level in tow vehicle. Add as needed. **DO NOT OVERFILL.**
2. Tire pressure should be 18 psi (1.3 bar) on Big Vac tires and 20 psi (1.4 bar) on castor wheels.
3. Check hardware for loose or missing nuts, bolts, screws, etc., and tighten or replace as needed.
4. Inspect hydraulic lines for damage or leaks. Never use hands to inspect leaks.
5. Check hydraulic fluid level in tank. Look at the sight gauge on the front left side of the tank. The oil level should be at 90°C (194°F). If level is low, add SAE 10W-40 API Service SJ or higher motor oil.
6. Check controls for smooth, proper working operation. Lubricate as needed.
7. Check and clean all debris from blower housing.

ADJUSTMENT OF BELT TENSIONER

There are four maximum belt tensioners on the Big Vac. Two control the tension on the belts on the blower housing, one each on the finger reel and the thatcher reel. The proper tension of the idler should be 12 to 15 as per the gauge (A) on the side of the tightener. Over tightening the belt will shorten the life of the belt and the machine may not perform to the best of its ability. To adjust belt tensioner, loosen bolt holding tensioner. Bring idler pulley tight to belts and turn tensioner into belts to 15°. Tighten holder bolt.

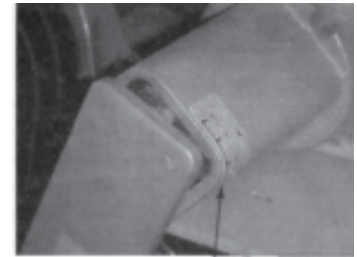

STARTING ENGINE

1. Make sure the fuel flow valve, located on the fuel tank, is "ON."
2. The ignition switch is located on remote operator control panel. Insert key (A) and turn clockwise until engine starts (C). Release key and it will return to run position (B). Use choke and hand throttle as necessary.
3. Allow engine to idle and warm up a few minutes.
4. Be sure the jack is all the way up and will clear all ground obstacles.

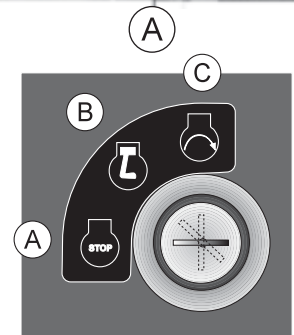

CONTROL PANEL ADJUSTMENT ARM

On the right hand side of machine is the adjustment lock arm, by lifting up you can adjust the control panel by moving it forward or rearward. Make certain that the lock arm is locked back in place after adjustment. For up and down adjustment loosen the four adjustment bolts place the control panel to where you want it and tighten the four bolts.

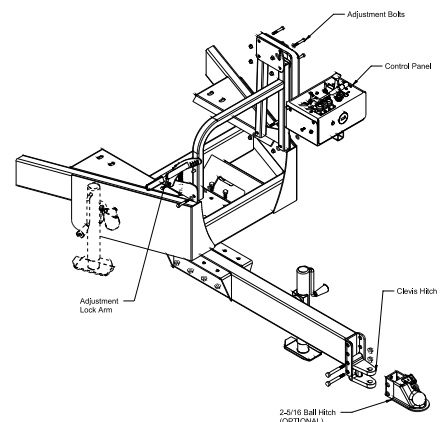

BATTERY

BATTERY

Batteries normally produce explosive gases which can cause personal injury. Do not allow flames, sparks or any ignited object to come near the battery. When charging or working near battery, always shield your eyes and always provide proper ventilation.

Battery cable should be disconnected before using "Fast Charge".

Charge battery at 15 amps for 10 minutes or 7 amps for 30 minutes. Do not exceed the recommended charging rate. If electrolyte starts boiling over, decrease charging.

Always remove grounded (-) battery clamp first and replace it last. Avoid hazards by:

1. Filling batteries in well-ventilated areas.
2. Wear eye protection and rubber gloves.
3. Avoid breathing fumes when electrolyte is added.
4. Avoid spilling or dripping electrolyte.



Battery Electrolyte is an acidic solution and should be handled with care. If electrolyte is splashed on any part of your body, flush all contact areas immediately with liberal amounts of water. Get medical attention immediately.

JUMPSTARTING



Use of booster battery and jumper cables. Particular care should be used when connecting a booster battery. Use proper polarity in order to prevent sparks.

To jump start (negative grounded battery):

1. Shield eyes.
2. Connect ends of one cable to positive (+) terminals of each battery, first (A) then (B).
3. Connect one end of other cable to negative (-) terminal of "good" battery (C).
4. Connect other end of cable (D) to engine block on unit being started (NOT to negative (-) terminal of battery)

To prevent damage to other electrical components on unit being started, make certain that engine is at idle speed before disconnecting jumper cables.

OVERLOADING DEBRIS HOPPER AND VACUUM HOUSING WEAR

SMITHCO SWEEPER-VACS ARE DESIGNED TO CARRY THE FOLLOWING MAXIMUM LOADS:

Model 73-000 Big Vac V72E	1500 lbs. (608 kg)
Model 72-000 Big Vac V72	1500 lbs. (608 kg)

PLEASE NOTE THE FOLLOWING:

1. Loads heavier than that will damage the unit.
2. Such damage is not covered by warranty.
3. Overloading is particularly easy when collecting aerifier cores.
4. The hoppers on the Big Vac are large in order to hold 7 and 4 cubic yards respectively, of thatch, grass clippings, leaves and trash.
5. They will not hold 7 or 4 cubic yards of aerifier cores.
6. The maximum depth (in the debris hopper) of aerifier cores is:

Model 73-000 Big Vac V72E	12 in. (30 cm)
Model 72-000 Big Vac	12 in. (30 cm)

VACUUM HOUSING WEAR

The Big Vac are fitted with a wear resistant liner in the vacuum housing. This will provide additional housing life. Be sure the following points are explained to the user:

1. The vacuum housing and impeller must be cleaned each time the unit is used so the housing liner is inspected daily. Only Smithco Sweeper-Vacs provide a clean out/inspection port for easy inspection and cleaning.
2. When bare steel is visible at any point in the housing lining, the lining must be replaced. It is expected the liner will wear and be replaced. It is a vast improvement over competitive units with no liners.
3. Replacement of the liner or the vacuum housing due to wear is normal and is not covered by warranty.
4. Collection of aerifier cores causes extreme wear on the liner (and if unchecked, on the housing).
5. Caution users that, while Smithco Sweeper-Vacs do an excellent job collecting cores, the lining (and the housing) will wear quickly in such use.

RUBBERIZED BOOT

The rubberized boot between main unit and sweeper head is subject to wear and damage from debris. Unless defective, replacement of this boot is not covered by warranty.

STORAGE

1. Before storing clean machine thoroughly.
2. Check bolts and nuts, tighten as necessary.
3. Make all repairs that are needed and remove any debris.
4. Store in a clean and dry area.



WIRING DRAWING

Diagrams

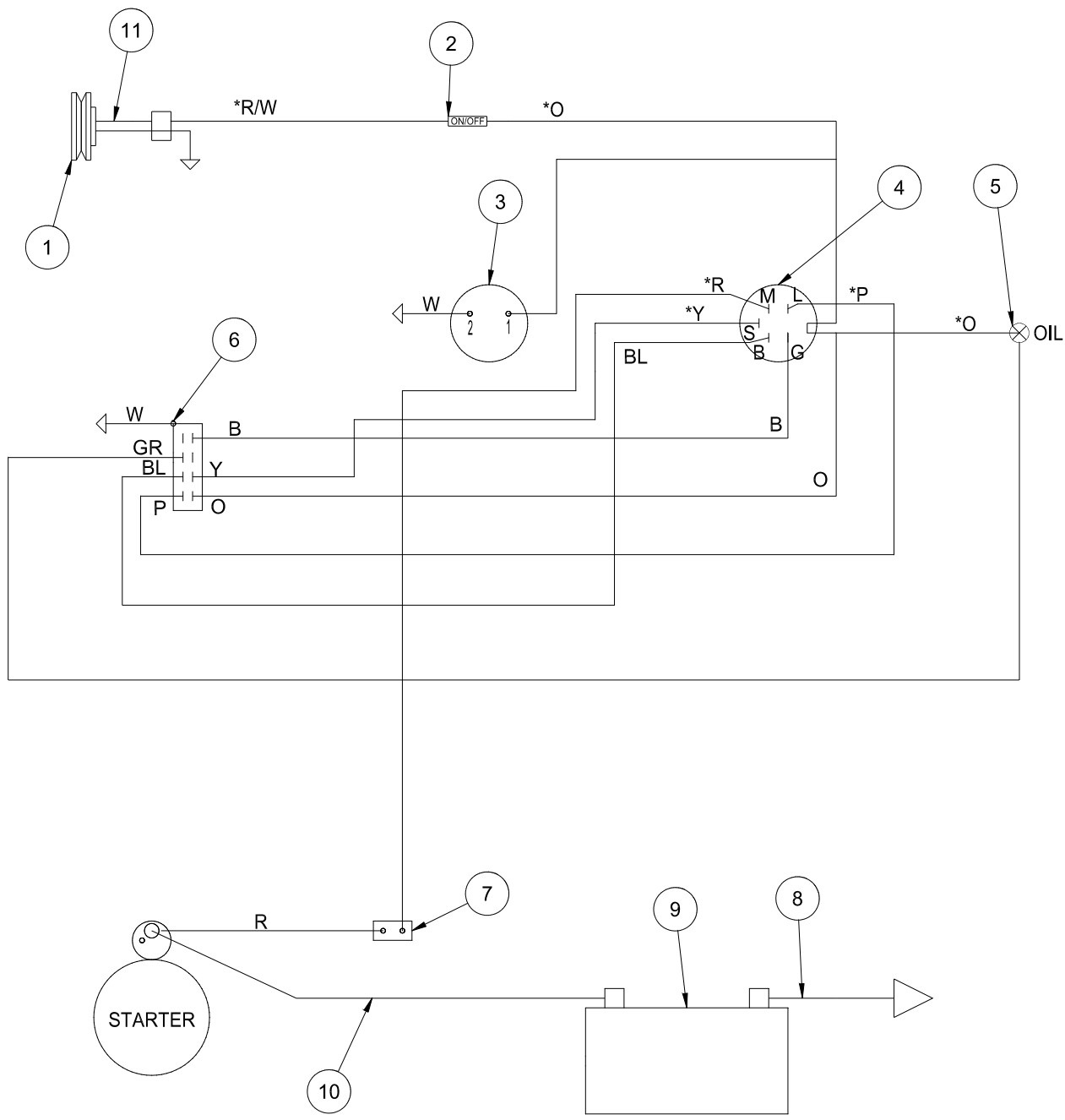

WIRING PARTSLIST

REF#	PART#	DESCRIPTION	QUANTITY
1	78-368	Electric Clutch	1
2	15-314	Toggle Switch	1
	15-472	Switch Boot	1
3	12-017	Hour Meter	1
4	13-488	Ignition Switch	1
5	78-340	Oil Light	1
6		Plug on Engine	1
7	8975	30 Amp Circuit Breaker	1
	8977	Circuit Breaker Boot	1
8	48-147	Battery Cable Black	1
9	22-073	Battery (optional)	1
10	75-718	Red Battery Cable with Boot	1
	78-442	Wire Harness (includes all wire colors with *)	

HYDRAULIC DRAWING

Diagrams

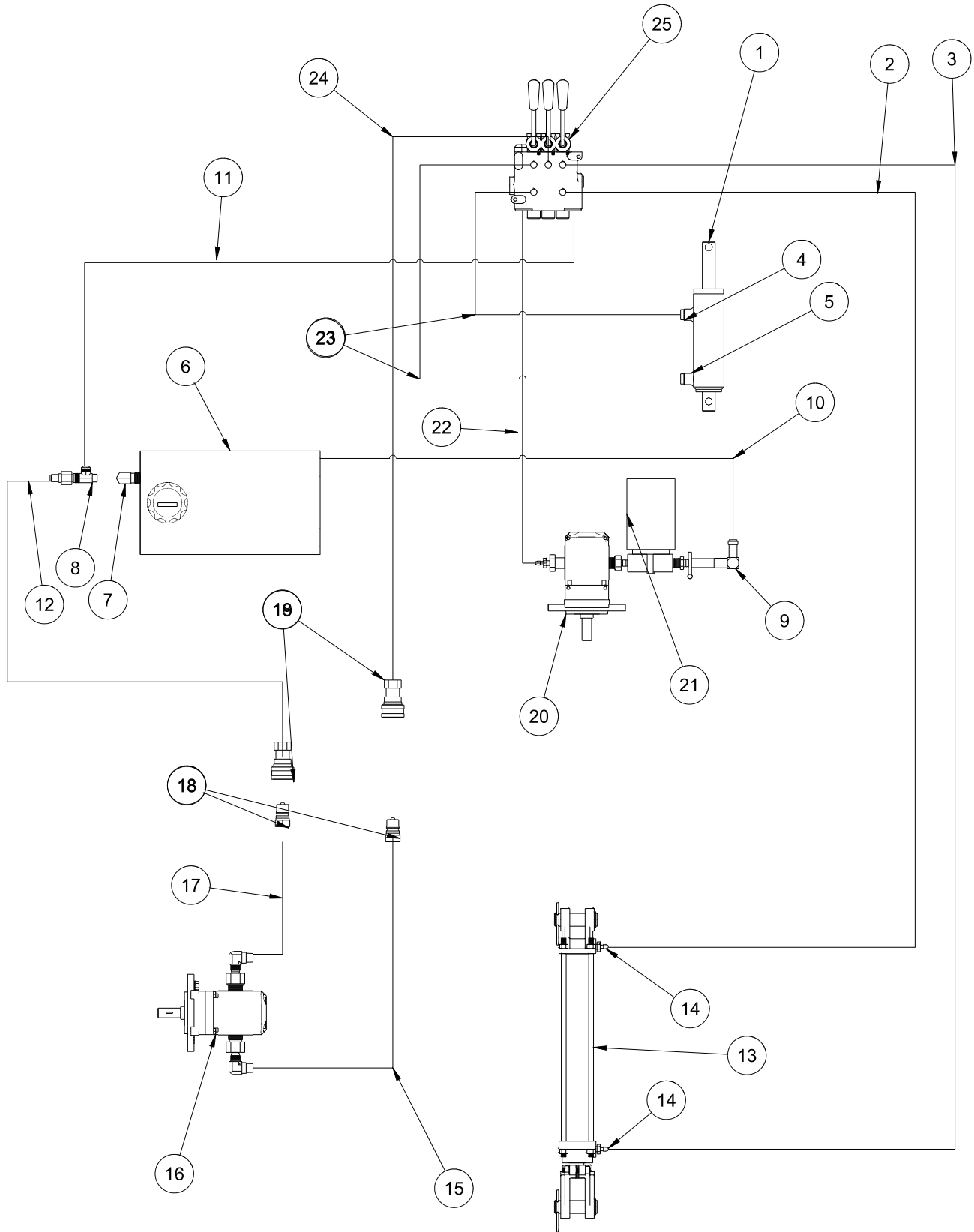

HYDRAULIC PARTSLIST

REF#	PART#	DESCRIPTION	QUANTITY
1	10-187	Hydraulic Cylinder	1
	14-273	Seal Kit	
	HCP-12-200	Clevis Pin 1/2 x 2	2
	HP-18-100	Cotter Pin 1/8 x 1	2
2	73-012	Hydraulic Hose 186"	1
3	73-011	Hydraulic Hose 206"	1
4	18-169	Adapter 3/8 SAE	1
5	78-365	Adapter with Orifice	1
6	60-473	Oil Tank	1
	13-747	Filler Breather	1
	13-586-03	Neck	1
7	17-019	Male Elbow	1
8	18-190	Tee	1
9	23-142	Connector	1
10	8917-9	5/8 Suction Hose 9"	1
	18-040	Hose Clamp	2
11	73-015	Hydraulic Hose 90"	1
12	73-017	Hydraulic Hose 53"	1
13	72-040	Hydraulic Cylinder	1
	72-040-01	Seal Kit	
14	23-184	Male Connector	2
15	72-075	Hydraulic Hose	1
16*	72-199	Hydraulic Motor	1
17	72-074	Hydraulic Hose	1
18	72-043	Quick Coupler 1/2" Male End	2
19	72-046	Quick Coupler 1/2" Female End	2
20*	78-413	Hydraulic Pump	1
21	23-006	Oil Filter	1
	23-031	Replacement Filter	
22	73-016	Hydraulic Hose 90"	1
23	73-013	Hydraulic Hose 118"	2
24	73-014	Hydraulic Hose 94"	1
25	78-416	Hydraulic 3-Bank Bank Valve	1

* **No other parts are replaceable for hydraulic motor or pump.**

HYDRAULIC PRESSURES	Front	Rear
Pump Displacement	.90 in ³ /rev	.40 in ³ /rev
Pump Input Speed (up to)	4000 rpm	4000 rpm
Max. Operating Pressure	3600 psi	3600 psi
Max. Inlet Vacuum	10 in. Hg	10 in. Hg
Max. Case Pressure	80 psi	80 psi

Operator's



Big Vac Engine Drive

73-000-A

SN: 73001

January, 2006

Product Support:

Hwy 55 & Poplar Ave; Cameron WI 54822

1-800-891-9435 productsupport@smithco.com

CONTENTS

Introduction.....	1-10
Introduction	1
Symbols.....	2-3
Safe Practices	4
Specifications	5
Optional Equipment	5
Setup	6
Overloading Debris Hopper and Vacuum Housing Wear	7
Controls & Instruments.....	8
Operation	9
Battery	10
Diagrams	12-15
Wiring Drawing	12-13
Hydraulic Drawing	14-15
Other	16
Declaration of Conformity-English	16
Warranty	Inside Back Cover

Introduction

Service

Diagrams

Parts

Accessories

Reference

The Smithco Commercial Products Two-Year Limited Warranty

Smithco, Inc. (Smithco) warrants your 2007 or newer Smithco Commercial Product (“Product”) purchased after January 1, 2007, to be free from defects in materials or workmanship for the period of time listed below. Where a warrantable condition exists, Smithco will repair the Product at no cost to you including diagnosis, labor (at the Smithco standard labor rate, subject to the Smithco flat rate schedule), and parts.

Warranty Duration is:

- (1) **Two years, 1500 operational hours* from the date of delivery to the original purchaser or three years from the date of original manufacturer of the product, whichever occurs first. (*Products equipped with hour meter).**
- (2) **Products used in rental situations are covered for 90 days from date of delivery to original user/renter.**

Owner Responsibilities:

As the Product owner, you are responsible for required maintenance and adjustments stated in your Owner’s Manual. Failure to perform required maintenance and adjustments can be grounds for disallowing a warranty claim. **You are particularly responsible to train all present and future operators of this product on the safe operation of this product at your location.**

Instructions for Obtaining Warranty Service:

You are responsible for notifying the Authorized Smithco Products Distributor from whom you purchased the Product as soon as you believe a warrantable condition exists and not later than 30 days from discovery of the condition.

If you need help locating an Authorized Smithco Distributor, or if you have questions regarding your warranty rights or responsibilities, you may contact us at:

Smithco Product Support Department
200 W Poplar PO Box 487
Cameron, Wisconsin 54822

Telephone: 1-800-891-9435 E-Mail: ProductSupport@smithco.com

Maintenance Parts:

Parts scheduled for replacement as required maintenance (“Maintenance Parts”), are warranted for the period of time up to the scheduled replacement time for that part.

Items/Conditions Not Covered:



Not all product failures or malfunctions that occur during the warranty period are defects in materials or workman-ship. The items/conditions listed below are not covered by this warranty:



Product failures which result from the use of non-Smithco replacement parts, or from installation and use of add-on, modified, or unapproved accessories are not covered.



Product failures which result from failure to perform required maintenance and/or adjustments are not covered.



Product failures that result from operating the Product in an abusive, negligent or reckless manner are not covered.



This warranty does not apply to parts subject to consumption through use, unless found to be defective. Examples of parts which are consumed, or used up, during normal Product operation include, but are not limited to: blades, tines, teeth, scarifiers, rakes, plates, wear plates, castor wheels, tires, batteries, filters, belts, nozzles, etc.



This warranty does not apply to failures caused by out-side influence. Items considered to be outside influence include, but are not limited to, weather, storage practices, contamination, use of unapproved coolants, lubricants, additives, or chemicals, etc.



This warranty does not apply to normal “wear and tear” items. Normal “Wear and Tear” includes, but is not limited to, damage to seats due to wear or abrasion, worn painted surfaces, scratched decals or windows, etc.



Smithco may require the return of failed parts or components in order to determine the validity of any warranty claim.



Smithco will not be obligated to replace components of other manufacturers if inspection by the original component manufacturer indicates that failure was due to normal wear and tear, expected consumption through use or improper care or service.

Other Legal Disclaimers:

The above remedy for product defects through repair or replacement by an authorized Smithco distributor or dealer is the purchaser’s sole remedy for any defect. This warranty gives you specific legal rights, and you may also have other rights which vary from state to state.

THERE ARE NO OTHER EXPRESS WARRANTIES OTHER THAN THOSE SET FORTH ABOVE. ALL IMPLIED WARRANTIES OF MERCHANTABILITY AND FITNESS FOR USE ARE LIMITED TO THE DURATION OF THE LIMITED WARRANTIES CONTAINED HEREIN.

Some states may not allow limitations on how long an implied warranty lasts, so the above limitation may not apply to you.

THE SMITHCO COMPANY IS NOT LIABLE FOR INDIRECT, INCIDENTAL OR CONSEQUENTIAL DAMAGES IN CONNECTION WITH THE USE OF THE PRODUCT, INCLUDING ANY COST OR EXPENSE OF PROVIDING A SUBSTITUTE PRODUCT OR SERVICE DURING PERIODS OF MALFUNCTION OR NON-USE.

Some states may not allow the exclusion of indirect, incidental or consequential damages, so the above exclusion may not apply to you.

Smithco neither assumes, nor authorizes any person to assume for it, any other liability in connection with the sale or use of this product.

SMITHCO, INC.

Wayne, PA 19087

