

Operator's



Spray Star 1300

Truck Model 30-500-A

TeeJet Radion® 8140 1302

TeeJet® 744 1304

TeeJet Radion/DynaJet® 1306/1307/1308

TeeJet Matrix/DynaJet® 1318/1320/1324

SN: 130013

Product Support:

Hwy 55 & Poplar Ave; Cameron WI 54822

1-800-891-9435 productsupport@smithco.com

CONTENTS

Introduction	1-8
Introduction	1
Symbols	2
General Safe Practices	3-6
Specifications	7
Optional Spray Equipment	7
Set Up	8
Operation	9-14
Controls & Instruments.....	9-10
Operating Instructions	11-12
Tank Agitation.....	13
Spray Cleaning.....	14
Diagrams.....	15-17
Wiring	15-16
Hydraulic	17
Reference.....	18-20
Declaration of Conformity.....	18-19
Quick Reference	20
Warranty.....	

Thank you for purchasing a **Smithco** product.

Read this manual and all other manuals pertaining to the Spray Star 1300 carefully as they contain safety, operating, assembly and maintenance instructions. Failure to do so could result in personal injury or equipment damage. Use in conjunction with appropriate TeeJet Manuals.

Keep manuals in a safe place after operator and maintenance personnel have read them. Right and left sides are from the operator's seat, facing forward.

WARNING

Failure to follow cautious operating practices can result in serious injury to the operator or other persons. The owner must understand these instructions, and must allow only trained persons who understand these instructions to operate this vehicle.

All **Smithco** machines have a Serial Number and Model Number. Both numbers are needed when ordering parts. The serial number plate on the Spray Star 1300 is located on right hand frame rail. Refer to engine manual for placement of engine serial number.

For product and accessory information, help finding a dealer, or to register your product please contact us at www.Smithco.com.

Information needed when ordering replacement parts:

1. Model Number of machine
2. Serial Number of machine
3. Name and Part Number of part
4. Quantity of parts

For easy access record your Serial and Model numbers here.

Model Number: _____

Serial Number: _____

Date of Purchase: _____

SMITHCO CUSTOMER SERVICE 1-800-891-9435

SYMBOLS

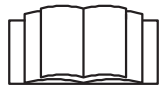

Read Operator's Manual



Engine Stop



Engine Start

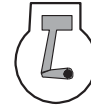

Engine Run



Engine Oil

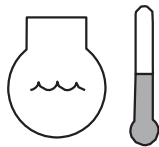

Water Temperature



1000/mi
RPM

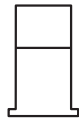

Gasoline



Diesel



Glow Plug



Hour Meter



Hand Throttle



Choke

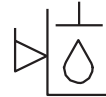

Hydraulic Oil Level



Ground Speed



Park Brake



Park Brake Release



Fast



Slow



Lift Arm

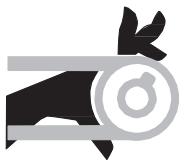

Moving Parts



Pinch Point

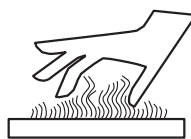

Hot Surface



Hydraulic Fluid Penetration



No Riders

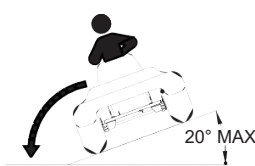

Rollover Danger
20° MAX

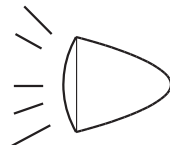

Headlamp

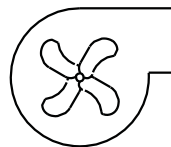

Blower



Warning
Danger
Caution



Seat Belt

Read and understand this manual and all safety signs before operating and maintaining. Review the safety instructions and precautions annually.

TAKE NOTE! THIS SAFETY ALERT SYMBOL FOUND THROUGHOUT THIS MANUAL IS USED TO CALL YOUR ATTENTION TO INSTRUCTIONS INVOLVING YOUR PERSONAL SAFETY AND THE SAFETY OF OTHERS. FAILURE TO FOLLOW THESE INSTRUCTIONS CAN RESULT IN INJURY OR DEATH.



Safety Alert Symbol

This symbol with a warning statement means:
WARNING! BE ALERT!
YOUR SAFETY IS INVOLVED!
Carefully read the message that follows

SAFETY SIGNAL WORDS

Note the use of the signal words DANGER, WARNING and CAUTION with the safety messages. The appropriate signal word for each has been selected using the following guidelines:



DANGER

DANGER: Red. Indicates an imminently hazardous situation that, if not avoided, will result in death or serious injury. This signal word is to be limited to the most extreme situations typically for machine components which, for functional purposes, cannot be guarded.



WARNING

WARNING: Orange. Indicates a potentially hazardous situation that, if not avoided, could result in death or serious injury, and includes hazards that are exposed when guards are removed. It may also be used to alert against unsafe practices.



CAUTION

CAUTION: Yellow. Indicates a potentially hazardous situation that, if not avoided, may result in minor or moderate injury. It may also be used to alert against unsafe practices.



IMPORTANT

IMPORTANT: Blue. Indicates procedures which should be followed to avoid damage to the machine.

SAFETY DECAL LOCATION

⚠ WARNING

REMEMBER: If Safety Decals have been damaged, removed, become illegible or parts replaced without decals, new decals must be applied. New decals are available from your authorized distributor.

This is a list of decals located on the Spray Star 1300. Part number, description and location will help in re-ordering a decals.

- A 15-463 Decal Spray Pump
- B 25-370 Decal, 88 dBA
- C 25-277 Decal, Battery Warning
- D 27-093 Decal, Hydraulic Oil
- E 25-286 Decal, Pinch Point
- F 25-298 Decal, Warning Hot
- G 25-307 Decal, Fuel Only
- H 30-402 Decal, Control Panel

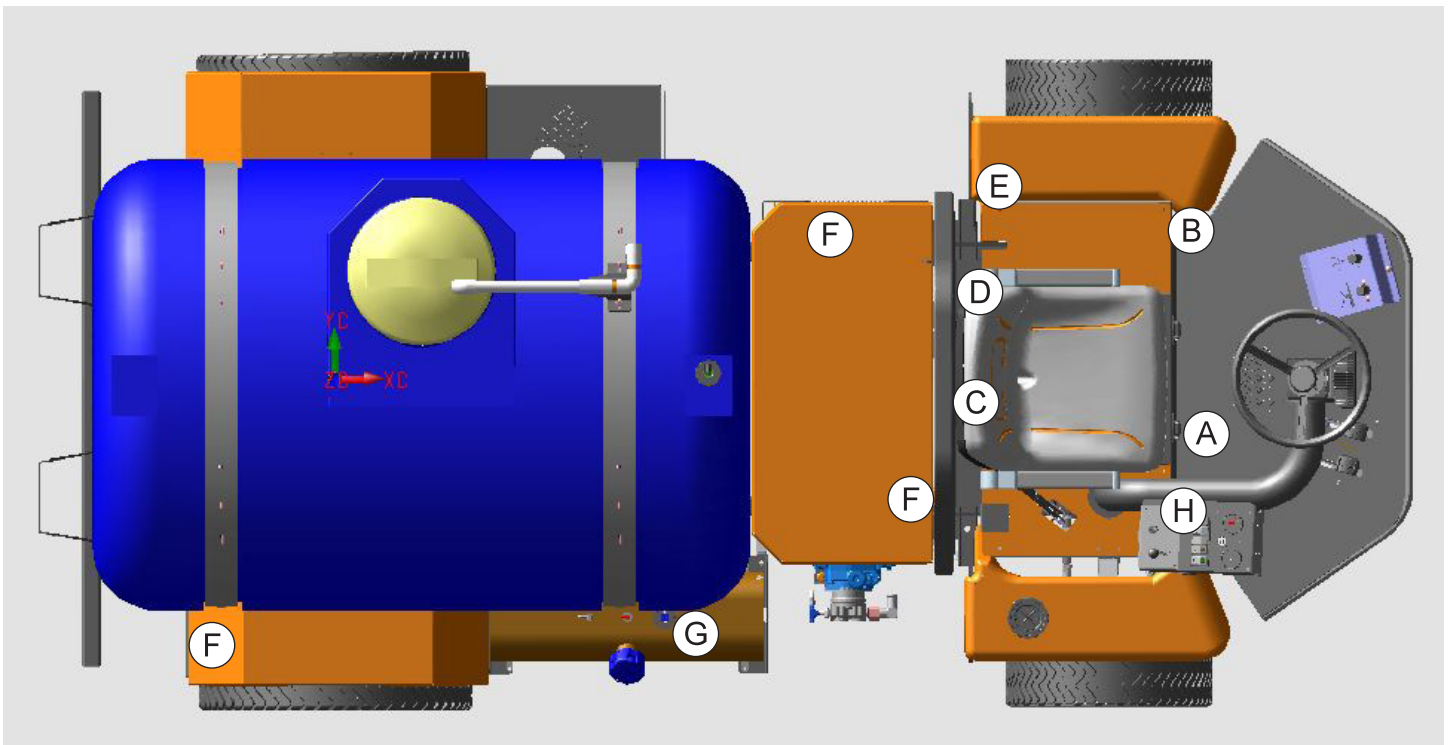



1. It is your responsibility to read this manual and all publications associated with this machine.
2. Never allow anyone to operate or service the machine or its optional equipment without proper training and instructions. Never allow minors to operate any equipment.
3. Learn the proper use of the machine, the location and purpose of all the controls and gauges before you operate the equipment. Working with unfamiliar equipment can lead to accidents.
4. Wear all the necessary protective clothing and personal safety devices to protect your head, eyes, ears, hands and feet. Operate the machine only in daylight or in good artificial light.
5. Inspect the area where the equipment will be used. Pick up all debris you can find before operating. Beware of overhead obstructions and underground obstacles. Stay alert for hidden hazards.
6. Never operate equipment that is not in perfect working order or without decals, guards, shields, or other protective devices in place.
7. Never disconnect or bypass any switch.
8. Carbon monoxide in the exhaust fumes can be fatal when inhaled, never operate a machine without proper ventilation.
9. Fuel is highly flammable, handle with care. When filling tank stop 1 inch(2.54 cm) from top. Leave room for expansion. **DO NOT OVERFILL.**
10. Keep engine clean. Allow the engine to cool before storing and always remove the ignition key.
11. Disengage all drives and set park brake before starting the engine.
12. Never use your hands to search for oil leaks. Hydraulic fluid under pressure can penetrate the skin and cause serious injury.
13. This machine demands your attention. To prevent loss of control or tipping of the vehicle:
 - A. Use extra caution in backing up the vehicle. Ensure area is clear.
 - B. Do not stop or start suddenly on any slope.
 - C. Reduce speed on slopes and in sharp turns. Use caution when changing directions on slopes.
 - D. Stay alert for holes in the terrain and other hidden hazards.
14. Before leaving operator's position:
 - A. Disengage all drives.
 - B. Shut engine off and remove the ignition key.
 - C. If engine has to run to perform any maintenance keep hands, feet, clothing and all other parts of body away from moving parts.
15. Keep hands, feet and clothing away from moving parts. Wait for all movement to stop before you clean, adjust or service the machine.
16. Keep the area of operation clear of all bystanders.
17. Stop engine before making repairs/adjustments or checking/adding oil to the crankcase.
18. Use parts and materials supplied by **Smithco** only. Do not modify any function or part.
19. Use caution when booms are down as they extend out beyond the center line of the machine.
20. The spray tank is a confined space, take precaution.

These machines are intended for professional maintenance on golf courses, sports turf, and any other area maintained turf and related trails, paths and lots. No guaranty as to the suitability for any task is expressed or implied.

SAFE SPRAYING PRACTICES

Persons engaged in the handling, preparation or application of chemicals must follow accepted practices to insure the safety of themselves and others,

1. **WEAR** protective clothing including: gloves, hat, respirator, eye protection and skin covering suitable for protection from chemicals being used.
2. **BATHE** thoroughly after any exposure to chemicals, giving particular attention to eyes, nose, ears and mouth.
3. **CLEAN** equipment and materials in accordance with employer, municipal and state regulations. Use only approved areas and drains.
4. **DISPOSE** of chemicals and rinse solutions by approved and legal means.
5. **PROVIDE** methods and materials for operators to wash eyes and hands immediately during the spraying process.
6. **PROVIDE** methods and materials for control, safe dilution and neutralization of chemical spills during preparation, spraying, transporting and cleanup.
7. Always check and follow the directions and safety warnings of the chemicals to be used.
8. Secure the discharge lines before starting the pump. An unsecured discharge line may whip.
9. Periodically inspect the pump and the system components.
10. Check hoses for weak or worn condition before each use. Make certain that all connections are tight and secure.
11. Do not operate unit with leaks, frayed, kinked hoses or tubing. Repair or replace immediately.
12. Use only pipe, hose and fittings rated for maximum pressure or pressure at which pressure relief valve is set at. When replacing pipe, hose or fittings, use new product.
13. Do not operate an engine in an enclosed area. Be sure the area is well ventilated.
14. Do not use these pumps for pumping water or other liquids for human or animal consumption.
15.  **WARNING** Do not pump flammable or explosive fluids such as gasoline, fuel oil, kerosene, etc. Do not use in explosive atmospheres. The pump should be used only with liquids compatible with the pump component materials.
16. Be sure all exposed moving parts are guarded and that all coupling devices are securely attached before applying power.
17. Before servicing, disconnect all power, make sure all pressure in the system is relieved, drain all liquids from the system and flush.
18. Protect pump from freezing conditions by draining liquid and pumping rust inhibiting antifreeze solution through the system, coating the pump interior.
19. **TRANSPORT** - Machine **must be stopped** to raise or lower booms. Because of cam system, if booms are raised in transit they can fall forward or backward when coming to a stop or while traveling on uneven terrain.
20.  **IMPORTANT** If using Simulated Speed with a Radion 8140, one needs to change back to Ground Speed for proper rate control when spraying.

WEIGHTS AND DIMENSIONS

Length	160" (4.1m)
Width	72" (1.8m)
Width w/ Booms Open	20' - 260" (6.6m) 18' - 240" (6.1m)
Height w/ Roll Bar	77" (2.0m)
Height w/ Booms Folded	20' - 96" (2.4m) 18' - 86"(2.2m)
Wheel Base	68" (1.4m)
Weight Empty	2700 lbs (1225 kg)
Weight Full	5100 lbs (2313 kg)

SOUND LEVEL (DBA)

At ear level	86 dBA
At 30 ft. (9.14 m)	75 dBA

ENGINE

Make	Kubota
Model#	WG1605
Code / Spec#	G-E3-KEA-3
Rated Horsepower	57 hp (42.5 kW) @3600RPM
Fuel (EMISSIONS)	Unleaded 87 Octane Gasoline Minimum
Cooling System	Liquid Cooled
Lubrication System	Full Pressure
Alternator	40 Amp

WHEELS & TIRE

Front: Two 22 x 11.00 x 10 Turf; 20 psi (1.4 bar)
 Rear: Two 29 x 14.00 x 15 Multi-Trac; 30 psi (2.0 bar)

SPEED

Infinitely Variable 0-10 m.p.h. (0-18 kph)

BATTERY

	Automotive type 24F - 12 volt
BCI Group	22NF
Cold Cranking Amps	900 minimum
Ground Terminal Polarity	Negative (-)
Maximum Length	10.25" (26 cm)
Maximum Width	6.88" (17 cm)
Maximum Height	10" (25 cm)

FLUID CAPACITY

Crankcase Oil	See Engine Manual
Fuel	17 gallon (64.4 liters)
Hydraulic Fluid	10 gallon (37.8 liters)
Grade of Hydraulic Fluid	SAE 10W-40 API Service SJ or higher Motor Oil

OPTIONAL EQUIPMENT

30-510	Water Meter Kit	30-509	Manual Hose Reel
32-518	18' HD Boom	30-501	Electric Hose Reel
32-520	20' HD Super Boom	30-502	26 Gallon Wash Tank
32-516	24' HD Super Boom	30-503	Foam Marker
30-006	Fresh Water Tank	15-835	Tank Rinse System
30-515	Chemical Cleanload Safe Fill	20-860	Sunshade Canopy

SETUP

The Spray Star 1300 arrives from **Smithco** setup and ready for service. Depending on freight conditions battery installed.

The spray system is normally shipped attached to the 1300 Prime Mover. If a spray system is to be fitted to a Prime Mover by a dealer or factory, assemble and attach the components in accordance with the parts drawings in the *Spray Star 1300 Parts/Service Manual*.

1. Check the tire pressure. The front tires are 20 psi (1.4 bar) and rear tires are 30 psi (2.0 bar).
2. Battery is located under seat. This is a negative grounding system.

⚠ WARNING

Connecting battery cables to the wrong post could result in personal injury and/or damage to the electrical system. Make

sure battery and cables do not interfere or rub on any moving part. Connect red positive (+) cable (A) to battery first. When disconnecting remove black negative (-) cable (B) first.

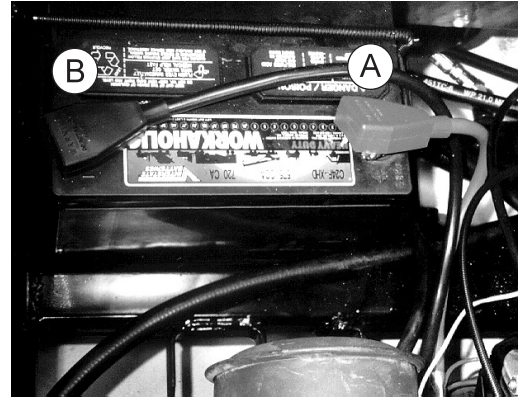

3. Check hydraulic fluid level in tank located under the seat. Remove cap and add SAE 10W-40 API Service SJ or higher motor oil if necessary. Fluid level should be about 2-2 $\frac{1}{2}$ " (5-6.4 cm) from the top of the tank when cold. **DO NOT OVERFILL.**
4. Fill fuel tank, located on right side, with Unleaded 87 Octane Gasoline Minimum. When filling the fuel tank stop when the fuel reaches 1 inch (2.54cm) from the top. This space is necessary for fuel expansion. **DO NOT OVERFILL.**

⚠ DANGER

Fuel is flammable, caution must be used when storing or handling it. Do not fill fuel tank while engine is running or an enclosed area, fumes are explosive and dangerous to inhale. DO NOT SMOKE while filling the fuel tank. DO NOT OVERFILL

5. Machine should be greased before starting, refer to *Spray Star 1300 Parts/Service Manual* for location.
6. Attach the Spray Boom and any other Optional Equipment to the Prime Mover, in accordance with instructions in the *Spray Star 1300 Parts/Service Manual*. The nozzles must be the correct distance above the turf as described in *Turf Spraying Guide*. The spray boom must operate properly and the outer sections must break away safely if an object is struck by them, they must then return to normal operation position.
7. Be sure to double check boom heights, nozzle spacing and displacement before spraying.
8. Machine is shipped with windshield washer fluid in to prevent freezing. Flush system completely with clear water. Fill tank with water and re-tighten the four bolts used to hold the tank in place.
9. Read operating instructions before starting.

⚠ IMPORTANT

Never allow pump to run dry! The valve on the suction side of the pump (between the pump and tank) must be fully open whenever the pump is operated.

CONTROLS & INSTRUMENTS

- A. Hour Meter - Located on the outside of control panel. The hour meter indicates hours of machine operation. It operates only when the ignition switch is on.
- B. Ignition Switch - The ignition switch has three positions: Off - Run - Start. Turn to start.
- C. Engine Indicator Light- Light flashes if there is an engine issue. If light is flashing. Shut off engine and refer to engine manual.
- D. Water Temperature Light - Temperature light will come on when the engine starts to over-heat.
- E. Oil Light - The oil light should come on when the ignition is on without the engine running and go out when the engine is running. The oil light will light when the oil pressure is low. If oil light should come on, shut engine off immediately and find the cause.
- F. Fuel Gauge - Electronic fuel gauge indicates level of fuel in tank.
- G. GPS Speedometer - The speedometer indicates ground speed of the vehicle in miles per hour and kilometers per hour using GPS technology. The antenna is on top of the ROPs.
- H. Lights - This rocker switch turns lights on by pushing on the top and off by pushing on the bottom.
- I. Spray Pump - This rocker switch turns the spray pump on by pushing on the top and off by pushing on the bottom. **The buzzer sounds if the pump is running dry.**
- J. Right Boom Switch - This rocker switch lifts and lowers the right boom.
- K. Left Boom Switch - This rocker switch lifts and lowers the left boom.
- L. Hand Throttle - The hand throttle is used to regulate engine speed.
- M. USB Port- Standard USB port.
- N. Ground Speed (Cruise) Control - This rocker switch initiates cruise control by pushing on the top and turning it off by pushing on the bottom. Works with ground Speed Control Foot switch.
- O. Cup Holder - Holds standard cup.
- P. Spray Boss Control - Engages and disengages speed boss. Forward is engage and all the way back is disengage. When the lever is engaged it sets a stop for the accelerator. The accelerator pedal must be used to maintain this speed. To adjust speed use the knob on the end of the lever, counter clockwise increases speed and clockwise decreases speed. Disengage the lever and you will have full accelerator pedal range.

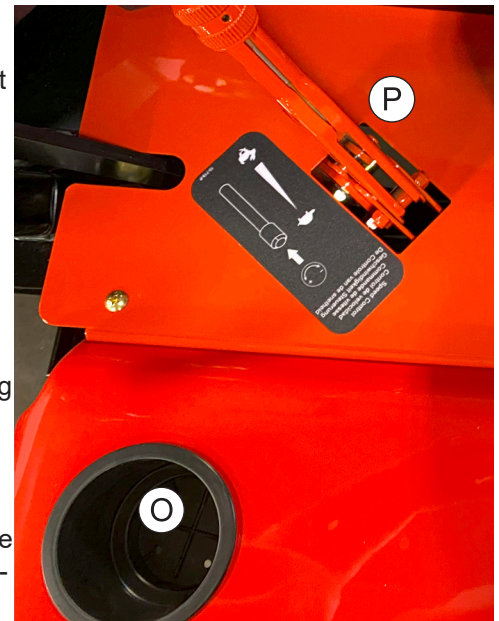
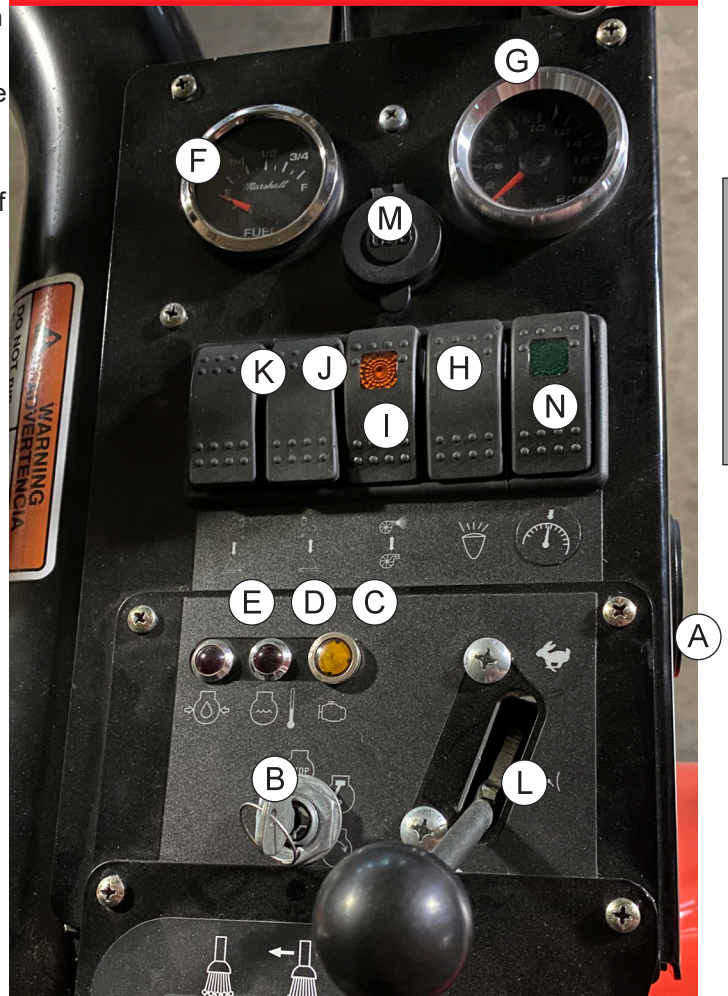

CONTROLS & INSTRUMENTS



- Q. Accelerator Pedal - This pedal controls ground speed. Press pedal to increase speed. Varying the amount of movement of the pedal will vary the ground speed.
- R. Reverse Pedal - This pedal controls reverse. Press pedal to move machine in reverse.
- S. Master Boom Switch - located on the left floorboard is used to override the master switch on the computer console of the **Radion Spray Systems**. By pushing down it will turn on/off the booms. For *TeeJet Systems*, the master switch on the computer **must be on**.
- T. Ground Speed (Cruise) Control Foot Switch - When rocker switch is turned on and desired speed is obtained, push foot speed control switch to set cruise. (See below).

SPEEDOMETER

This machine is equipped with a GPS Speedometer. **Please note** that if the speedometer has been powered off longer than 4 hours, it could take up to 1 minute to acquire signal due to the satellites moving significantly from your location. This is normal. The current draw is extremely low and will have virtually zero impact on a battery's charge. Hot start wire should be connected directly to battery +12volts and should remain powered 100% of the time. When GPS gauge first receives power the needle will sweep full counter clockwise towards 0 mph. Pointer will stay at 0mph and oscillate slightly at zero to indicate the GPS is acquiring satellites. GPS is not yet functional to indicate speed. Once satellites are acquired (15-45 seconds), the pointer will swing full scale and then back toward 0 mph to indicate it is now ready for operation.

GROUND SPEED CONTROL

The ground speed control does not work the same as an automotive type cruise. The ground speed control is located on the center floorboard and is used to lock forward speed.

TO ENGAGE:

1. Flip rocker switch 'On' (green light).
2. Obtain desired speed with foot pedal.
3. Step on foot switch to lock speed.
4. Push foot switch again to disengage.

CAUTION

To avoid abrupt stop, place foot on traction pedal before disengaging speed control.

TOWING

Brake must be disengaged for towing. The brake disengage cover is located at the center of the Auburn wheel drive on the rear wheels. To disengage the brake, remove the disengage cover and assemble the disengage cover with the dimple center protruding inward. This will release the brake shaft. **Road speeds must not exceed 20 MPH.** Re-assemble the disengage cover back to its original way when done towing.

WARNING

Machine is in free wheel mode when towing.
Machine has no braking capabilities when being towed.

Before operating the Spray Star 1300, become familiar with all controls and functions. Also complete all maintenance requirements and read all safety warnings. Knowing the Spray Star 1300 thoroughly, how it operates, and by doing the prescribed maintenance steps, you can expect trouble free operation for years to come.

SAFETY

Safety needs to always be the concern of the operator on a moving vehicle or any machine with moving parts.

1. Keep all shields and guards in place.
2. Keep the parking brake engaged any time the operator is away from the vehicle or whenever service is performed.
3. Always wear the necessary protective clothing and equipment.
4. Turn engine off when refueling or performing maintenance not specifically requiring engine power.

DAILY CHECKLIST

1. Check the engine oil level. Add as needed. **DO NOT OVERFILL.** Refer to engine owner's manual for oil grade and procedure.
2. Tire pressure should be 20 psi (1.4 bar) on front and 30 psi (2.0 bar) on back.
3. Inspect the electrical system and battery cables for loose connections or frayed wiring. Replace any faulty equipment or tighten if loose.
4. Check hardware for loose or missing nuts, bolts, screws, etc., and tighten or replace as needed.
5. Inspect hydraulic lines for damage or leaks. Never use hands to inspect for leaks.
6. Check the hydraulic fluid level. The hydraulic fluid tank is located under the seat. The fluid level should be 2"-2½" (5 - 6.4 cm) from the top of the tank when cold. Use only SAE 10W-40 API Service SJ or higher Motor Oil.
7. Inspect the steering, throttle and shift linkages for good hookups and clear travel.
8. Check controls for smooth, proper working operation. Lubricate as needed.
9. Check anti-vibration mounts on engine frame.

STARTING THE ENGINE

1. The ignition switch is located on the control panel. Insert the key (A) and turn clockwise to position(C) until the engine starts. Release the key and it will return to the run position (B).
2. Allow engine to idle and warm up before selecting direction of travel.

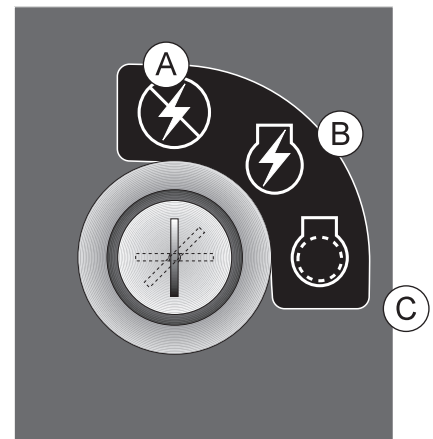

STOPPING THE ENGINE



IMPORTANT

If the engine has been running under high power, let it run at slow idle speed a few minutes to cool the engine down, before turning the ignition switch to the OFF position.

1. Disengage spray pump.
2. Move the throttle lever to "slow" and turn ignition key to the "off" position.
3. Remove the ignition key and engage the park brake.



CAUTION

Never leave the vehicle unattended with the engine running. Always bring the vehicle to a complete stop, engage park brake, turn key off and remove key.

OPERATION

Before using the Spray Star, the operator and spray technician must familiarize themselves with all of the information on chemical spraying contained in the *Turf Spray Guide*.

All testing and calibrating of sprayers is to be done with water, not chemicals. This insures the safety to all involved in performing the calibration operation. Only after all calibration procedures are completed should chemical be added to the sprayer.

HILLSIDE OPERATION

Do NOT stop or start suddenly on any slope. Be especially cautious when changing direction. **Do NOT** operate on slopes greater than 10°.

BATTERY

Batteries normally produce explosive gases which can cause personal injury. Do not allow flames, sparks or any ignited object to come near the battery. When charging or working near battery, always shield your eyes and always provide proper ventilation.

Battery cable should be disconnected before using "Fast Charge".

Charge battery at 15 amps for 10 minutes or 7 amps for 30 minutes. Do not exceed the recommended charging rate. If electrolyte starts boiling over, decrease charging.

Always remove grounded (-) battery clamp first and replace it last. Avoid hazards by:

1. Filling batteries in well-ventilated areas.
2. Wear eye protection and rubber gloves.
3. Avoid breathing fumes when electrolyte is added.
4. Avoid spilling or dripping electrolyte.

⚠ WARNING

Battery Electrolyte is an acidic solution and should be handled with care. If electrolyte is splashed on any part of your body, flush all contact areas immediately with liberal amounts of water. Get medical attention immediately.

JUMP STARTING

Use of booster battery and jumper cables. Particular care should be used when connecting a booster battery. Use proper polarity in order to prevent sparks.

To jump start (negative grounded battery):

1. Shield eyes.
2. Connect ends of one cable to positive (+) terminals of each battery, first (A) then (B).
3. Connect one end of other cable to negative (-) terminal of "good" battery (C).
4. Connect other end of cable (D) to engine block on unit being started (NOT to negative (-) terminal of battery)

⚠ WARNING

To prevent damage to other electrical components on unit being started, make certain that engine is at idle speed before disconnecting jumper cables.

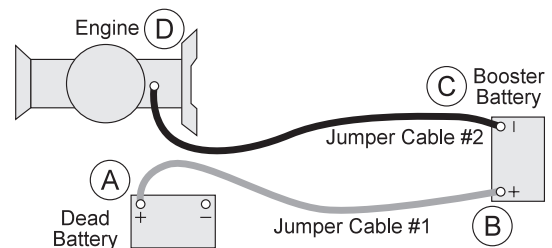

SPRAYER VALVE SETTINGS AND SPRAY TANK AGITATION

The 3-way valve on the suction side of the pump, between the tank and the pump must be open before pump is engaged. Close this valve only when necessary to clean the filter with spray material in the spray tank.

There is one manual flow control valve on the discharge side of the spray system. This valve controls the agitator. This valve may be opened as much as necessary to provide hydraulic agitation through the quadra-jet agitator in the tank bottom. This valve may be partially closed to prevent or reduce foam buildup from the spray materials inside the tank. When the liquid level in the spray tank reaches a certain level (usually 1-25 gallons (3.8-95 Liters) depending on terrain and other conditions) it may be necessary to close the valve in the agitator line in order to prevent loss of suction prime.

If your Spray Star is fitted with a hose reel, there is a second ball valve on the discharge system to supply material to the hose reel.

The Quadrajet agitation system operates with four venturi jets in the tank bottom. These jets have replaceable orifice discs which discharge the following amounts of spray material.

Nozzle Diameter	Input to Agitator in gpm	Input to Agitator in L/min	Agitator Pressure in psi	Agitator Pressure in bar	Agitator Output in gpm	Agitator Output in L/min
1/8"	1.9	7.2	25	1.7	6.3	23.8
1/8"	2.7	10.2	50	3.4	10.0	37.9
1/8"	3.8	14.4	100	6.9	15.0	56.8
5/32"	2.8	10.6	25	1.7	7.6	28.8
5/32"	4.2	15.9	50	3.4	12.2	46.2
5/32"	5.5	20.8	100	6.9	17.5	66.2
3/16"	3.6	13.6	25	1.7	9.1	34.4
3/16"	5.6	21.2	50	3.4	14.3	54.1
3/16"	7.9	29.9	100	6.9	18.7	70.8

You can change orifice disc sizes to enhance spray system performance. Smaller discs reduce amount of agitation (desirable in some foaming materials) and make more discharged liquid available for nozzles. Larger (or none) discs increase amount of agitation and make less discharged liquid available for nozzles.

AGITATION LINE STRAINER CLEANING

Agitation line strainer is located below the sprayer filter. This strainer catches impurities that go to the turbo-jet agitation system in the spray tank. It has a quick disconnect pin on it to remove the bowl. **After EVERY use**, remove bowl and clean screen. Replace screen as needed. We recommend a 50 Mesh screen.

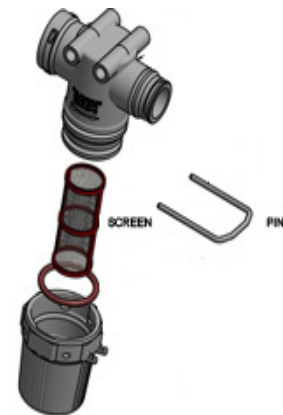

DYNAJET® NOZZLE CLEANING

The Nozzle Coil Assembly will need to be taken apart and cleaned on a regular basis. To take apart and clean you will need to use two wrenches provided with the DynaJet® System. Loosen the Nozzle assembly by placing a wrench on the tube assembly and one on the stainless cap. Hold one in place and turn the other wrench to loosen assembly. Once apart, clean with water and check for deteriorating parts. Replace parts as needed by ordering the Spare Parts Kit 20-673-01P.

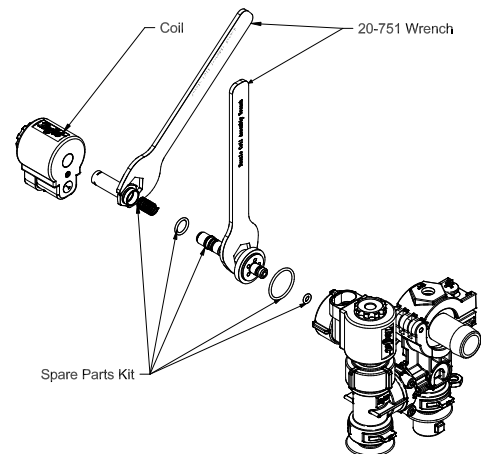

SPRAYER CLEANING

One of the most common causes for faulty-pump performance is corrosion inside the pump. Flush the pump and entire system with a solution that will chemically neutralize the liquid pumped. Mix according to manufacturer's directions. This will dissolve most residue remaining in the pump, leaving the inside of the pump clean for the next use.

TO PREVENT CORROSION

After cleaning the pump as directed, flush it with a permanent type automobile antifreeze (Prestone, Zerex, etc.) containing a rust inhibitor. Use a 50% solution that is, half antifreeze and half water. Then coat the interior of the pump with a substance which will prevent corrosion such as Fluid Film or WD40. If unit will not be used for an extended period of time, disconnect hoses into and out of the pump, seal openings to the pump with caps or tape. Dispose of fluids according to all federal, state and local regulations.

IMPORTANT

All chemicals and chemical residue must be removed after each use. Dispose of fluids and residue according to all federal, state and local regulations.

SPRAYER CLEANING

Empty tank and clean unit thoroughly after each use following these instructions:

1. Turn off 3-way valve and rinse inside of tank thoroughly with clean water, remove cap from valve to drain.
2. Fill tank ten percent full with clean water, Turn 3-way valve on and start pump and discharge water through spray hose or spray boom (with nozzles removed), until empty.
3. Turn off 3-way valve again and rinse tank interior thoroughly. Remove cap from 3-way valve to drain.
4. Rinse exterior of sprayer thoroughly with clean water.
5. This sprayer is equipped with a self cleaning strainer. The strainer uses the excess pump flow to bypass clogging particles back to the spray tank. There is a gap between the tapered inner cylinder and the screen face that causes the inlet fluid to flow at a high velocity past the screen face providing a continuous wash down of particles. For this wash down to occur a minimum of +GPM/23 l/min is required through the bypass line.

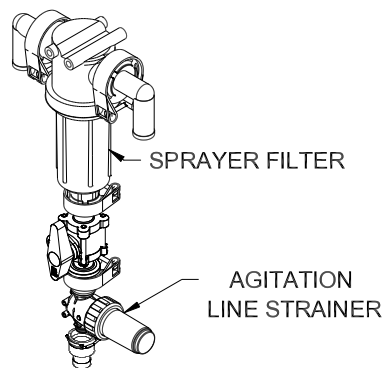

AGITATION LINE STRAINER CLEANING

Agitation line strainer is located below the sprayer filter. This strainer catches impurities that go to the turbo-jet agitation system in the spray tank. It has a quick disconnect pin on it to remove the bowl. **After EVERY use**, remove bowl and clean screen. Replace screen as needed. We recommend a 50 Mesh screen.

MANUAL HOSE REEL

Located at the back of the Spray Star on top of the tank. Open the ball valve located near the manifold valve to allow fluid to flow into the hose reel. Place the lockout pin in the unlocked position by pulling and turning it half a turn, this will allow you to pull out additional hose or to use the handle and wind up the hose. To prevent movement during transport or storage place the lockout pin in the locked position.

ELECTRIC HOSE REEL

Located at the back of the Spray Star on top of the tank. Open the ball valve located near the manifold valve to allow fluid to flow into the hose reel. To unwind hose just pull on the hose to get the desired amount. To wind up the hose make sure the toggle switch is in the ON position, push the momentary push button switch until you have reeled in the amount of hose desire. Turn off the safety switch when not in use.

FOAM MARKER

Located to the right of the control panel. Use lever on compressor to designate which boom is to be used to dispense foam. Use dial located on the foamer to adjust pressure for the amount of foam that will be dispensed. Switch on compressor also turns foamer on or off.

MAIN WIRING DIAGRAM

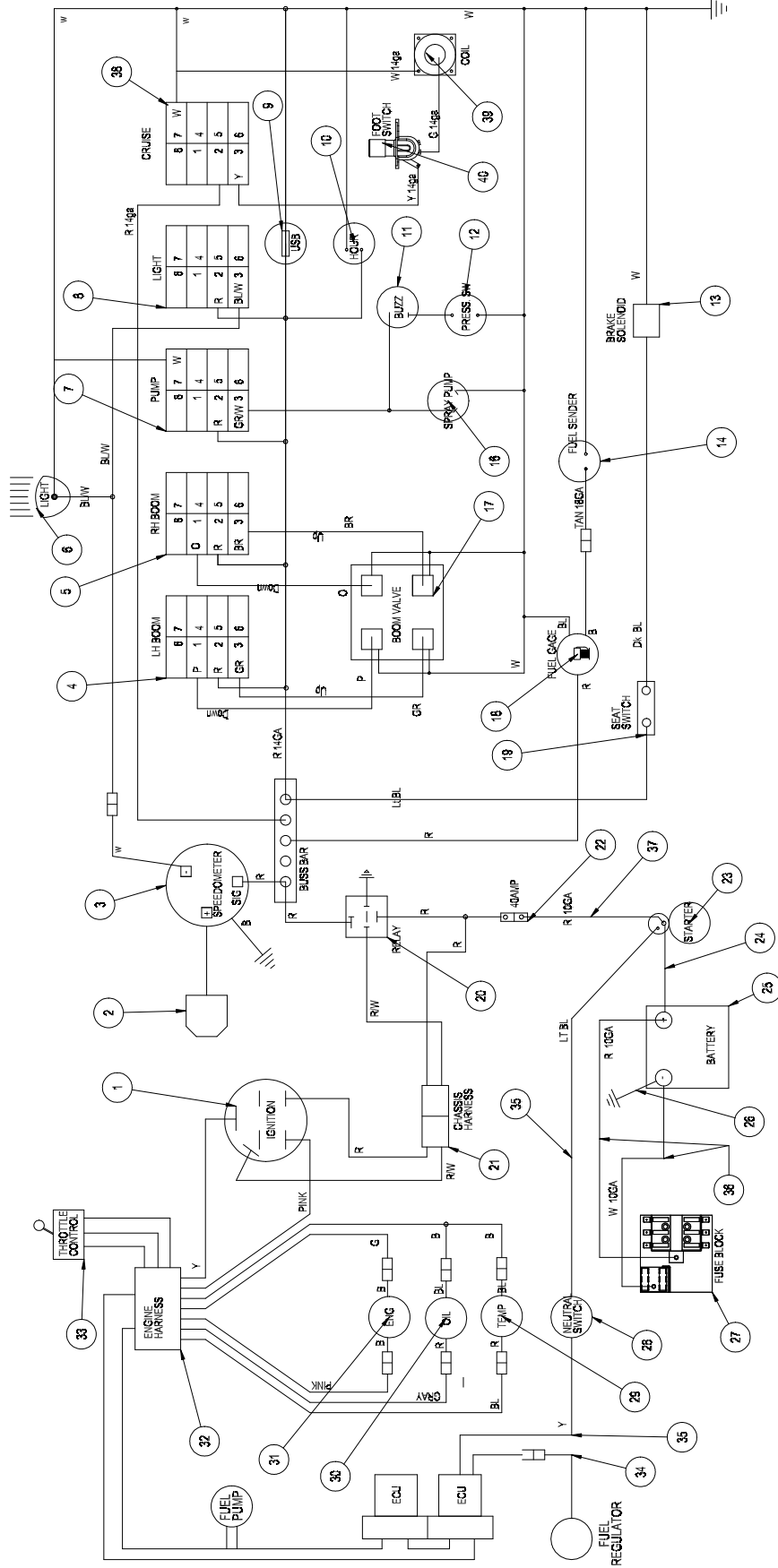

ENGINE WIRING DIAGRAM

Diagrams

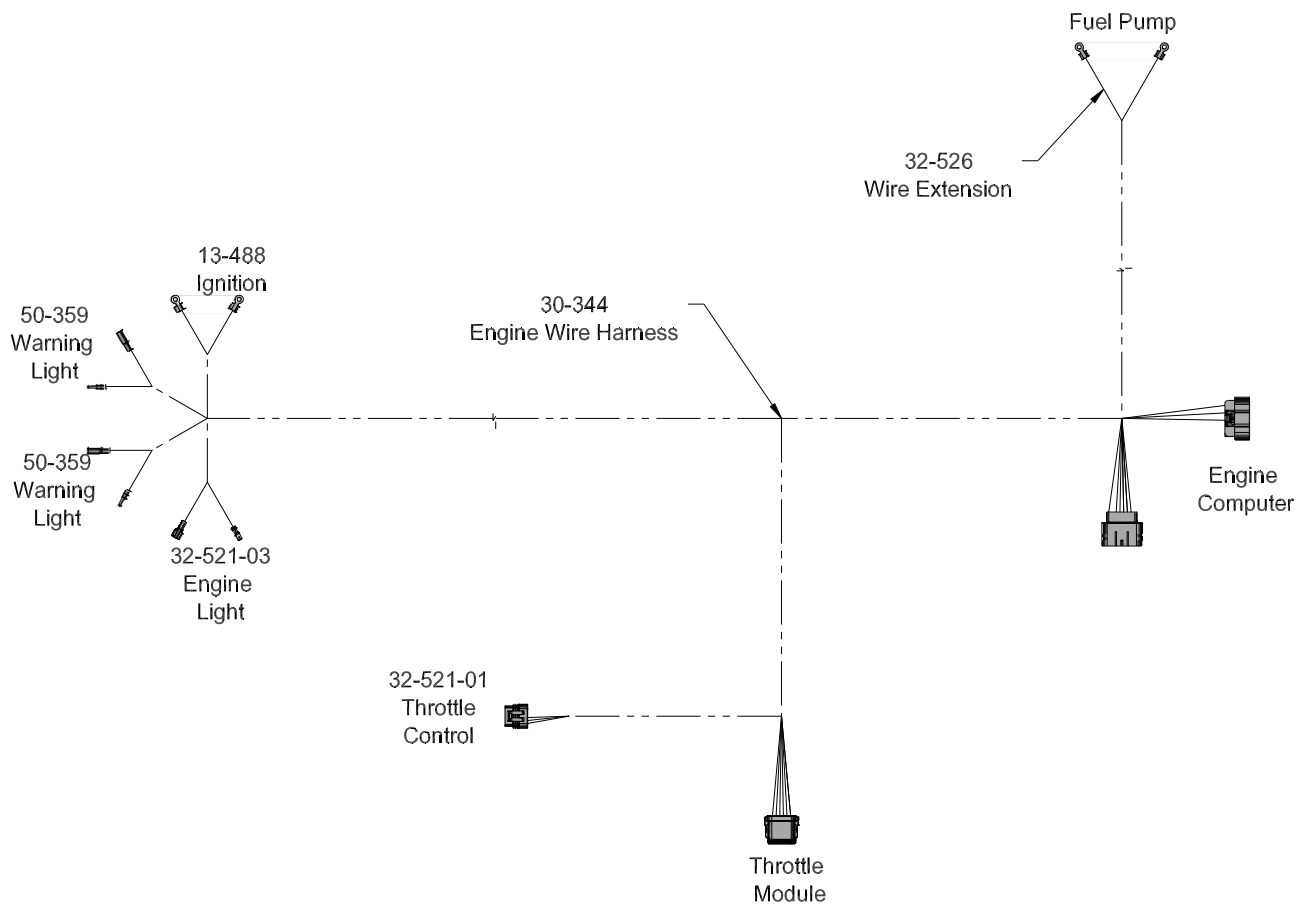

HYDRAULIC DIAGRAM

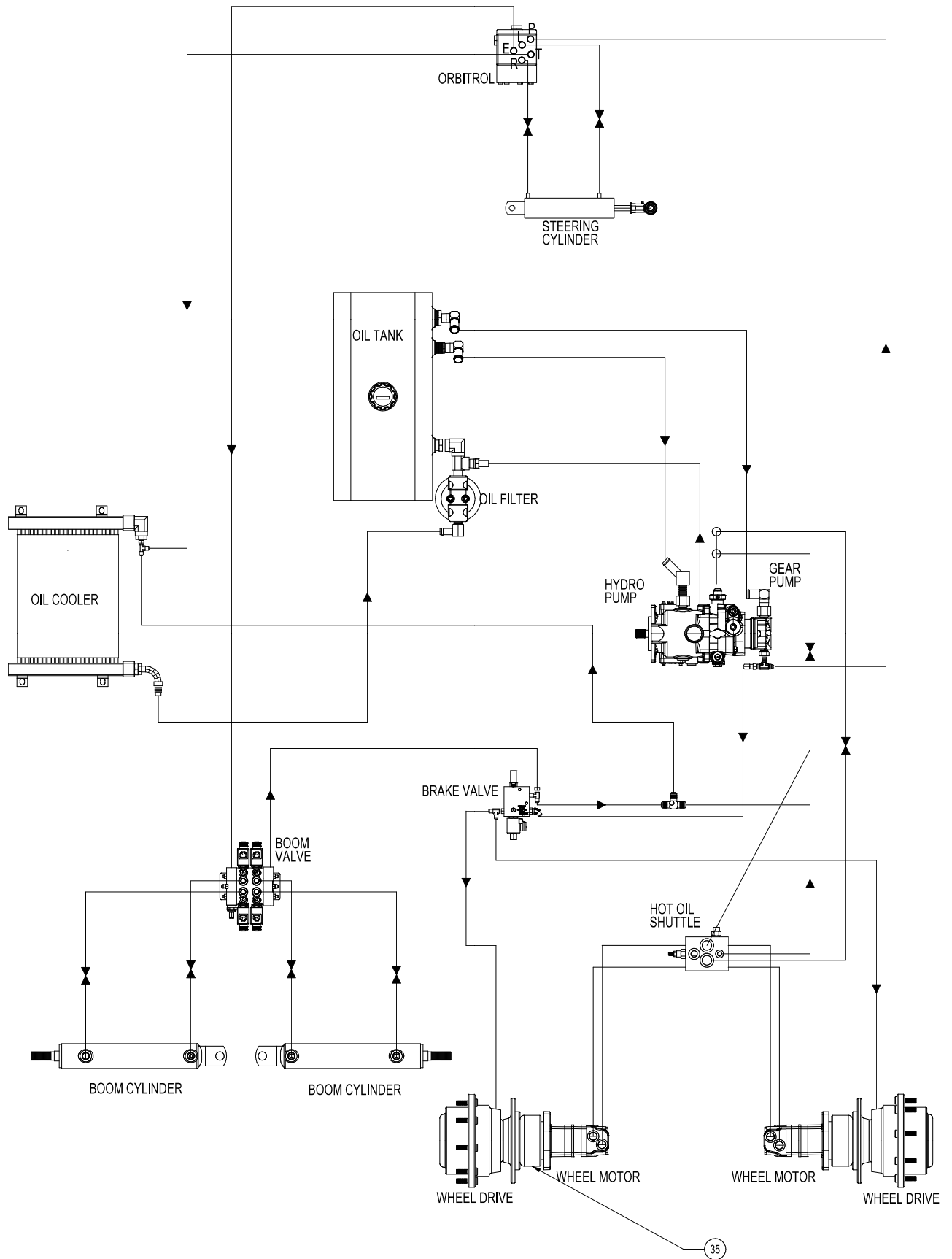

Diagrams

DECLARATION OF CONFORMITY

DECLARATION OF CONFORMITY • ДЕКЛАРАЦИЯ ЗА СЪОТВЕТСТВИЕ • PROHLÁŠENÍ O SHODĚ • OVERENSSTEMMELSESERKLÆRING • CONFORMITEITSVERKLARING • VASTAVUSDEKLARATSIOON • VAATIMUSTENMUKAISUUSVAKUUTUS • DECLARATION DE CONFORMITE • KONFORMITÄTSEKTLÄRUNG • ΔΗΛΩΣΗ ΣΥΜΜΟΡΦΩΣΗΣ • MEGFELELŐSÉGI NYILATKOZAT • DICHIARAZIONE DI CONFORMITÀ • ATBILSTĪBAS DEKLARĀCIJA • ΑΤΙΤΙΚΤΙΕΣ ΔΕΚΛΑΡΑΚΙJA • DIKJARAZZJONI TAL-KONFORMITÀ • DEKLARACJA ZGODNOŚCI • DECLARAÇÃO DE CONFORMIDADE • DECLARAȚIE DE CONFORMITATE • VYHLÁSENIE O ZHODE • IZJAVA O SKLADNOSTI • DECLARACIÓN DE CONFORMIDAD • DEKLARATION OM ÖVERENSSTÄMMELSE

Business name and full address of the manufacturer • Търговско име и пълен адрес на производителя • Obchodní jméno a plná adresa výrobce • Producentens firmanavn og fulde adresse • Bedrijfsnaam en volledig adres van de fabrikant • Tootja ärinimi ja täielik address • Valmistajan toiminimi ja täydellinen osoite • Nom commercial et adresse complète du fabricant • Firmenname und vollständige Adresse des Herstellers • Επισημια και ταχυδρομική διεύθυνση κατασκευαστή • A gyártó üzleti neve és teljes címe • Ragione sociale e indirizzo completo del fabbricante • Uzņēmuma nosaukums un pilna ražotāja adrese • Verslo pavadinimas ir pilnas gamintojo adresas • Isem kummerčiali u indirizz sħih tal-fabbrikant • Nazwa firmy i pełny adres producenta • Nome da empresa e endereço completo do fabricante • Denumirea comercială și adresa completă a producătorului • Obchodný názov a úplná adresa výrobcu • Naziv podjetja in polni naslov proizvajalca • Nombre de la empresa y dirección completa del fabricante • Tillverkarens företagsnamn och kompletta adress	Smithco Inc. 34 West Avenue Wayne, PA USA 19087-3314
Product Code • Код на продукта • Kód výrobku • Produktkode • Productcode • Toote kood • Tuotekoodi • Code produit • Produktcode • Код προϊόντος • Termékkód • Codice prodotto • Produkta kods • Produkto kodas • Kodiči tal-Prodott • Kod produktu • Código do Produto • Cod produs • Kód výrobku • Označka výrobca • Código de producto • Produktkod	30-500
Machine Name • Наименование на машината • Název stroje • Maskinnavn • Machinenam • Masina nimi • Laitteen nimi • Nom de la machine • Maschinenbezeichnung • Ονομασία μηχανήματος • Gépnév • Denominazione della macchina • Iekārtas nosaukums • Mašinos pavadinimas • Isem tal-Magna • Nazwa urządzenia • Nome da Máquina • Numele echipamentului • Názov stroja • Naziv stroja • Nombre de la máquina • Maskinens namn	Spray Star 1300
Designation • Предназначение • Označení • Betegnelse • Benaming • Nimetus • Tyypimerkintä • Pažymėjimas • Bezeichnung • Χαρακτηρισμός • Megnevezés • Funzione • Apzīmējums • Lithuanian • Denominazzjoni • Oznaczenie • Designação • Specificație • Označenie • Nomen stroja • Descripción • Beteckning	Turf Sprayer
Serial Number • Серийн номер • Sériové číslo • Seriennummer • Seriennummer • Seerianumber • Valmistusnumero • Numéro de série • Seriennummer • Σειριακός αριθμός • Sorozatszám • Numero di serie • Sérijas numurs • Serijos numeris • Numru Serjali • Numer serjiny • Número de Série • Număr de serie • Sériové číslo • Serijska številka • Número de serie • Seriennummer	1300101-1300500
Engine • Двигател • Motor • Motor • Motor • Mootor • Mootori • Moteur • Motor • Μηχάνη • Modulínév • Motore • Dzinējs • Variklis • Sahha • Netta Installata • Silnik • Motor • Motor • Motor • Motor • Motor • Motor	Kubota wg1605
Net Installed Power • Нетна инсталирана мощност • Čistý inštalovaný výkon • Installeret nettoeffekt • Netto geïnstalleerd vermogen • Installiered netovõimsus • Asennettu nettoteho • Puissance nominale nette • Installierte Nettoleistung • Καθαρή εγκατεστημένη ισχύς • Nettó beépített teljesítmény • Potenza netta installata • Paredzētā tīkla jauda • Grynoji galia • Wisa' tal-Qtugh • Moc zainstalowana netto • Potência instalada • Puterea instalată netă • Čistý inštalovaný výkon • Neto vgrajena moč • Potencia instalada neta • Nettoeffekt	57 kW
Conforms to Directives • В съответствие с директивите • Splňuje podmínky směrníc • Er i overensstemmelse med direktiver • Voldoet aan de richtlijnen • Vastab direktiividele • Direktiivien mukainen • Conforme aux directives • Entspricht Richtlinien • Ακολουθήστε πιστά τi Οδηγίες • Megfelel az irányelveknek • Conforme alle Direttive • Atbilst direktīvām • Atitinka direktīvų reikalavimus • Valutazzjoni tal-Konformità • Dyrektywy związane • Cumpre as Directivas • Respectă Directivile • Je v súlade so smernicami • Skladnost z direktivami • Cumple con las Directivas • Uppnåller direktiv	2006/42/EC; 2000/14/EC Annex VI . Part 1
Conformity Assessment • Оценка за съответствие • Hodnocení plnění podmínek • Overensstemmelsesvurdering • Conformiteitsbeoordeling • Vastavushindamine • Vaatimustenmukaisuuden arviointi • Evaluation de conformité • Konformitätsbeurteilung • Διαπίστωση Συμμόρφωσης • Megfelelőség-értékelés • Valutazione della conformità • Atbilstības novērtējums • Atitikties įvertinimas • Livell tal-Qawwa tal-Foss Imkejjel • Ocena zgodności • Avaliação de Conformidade • Evaluarea conformității • Vyhodnotenie zhodnosti • Ocena skladnosti • Evaluación de conformidad • Bedömning av överensstämmelse	2006/42/EC Annex VIII
Measured Sound Power Level • Измерено ниво на звукова мощност • Naměřený akustický výkon • Målte lydstyrkeniveau • Gemeten geluidsniveau • Mõõdetud helivõimsuse tase • Mitattu äänitehotaso • Niveau de puissance sonore mesuré • Gemessener Schalldruckpegel • Σταθμισμένο επίπεδο ηχητικής ισχύος • Mért hangteljesítményszint • Livello di potenza sonora misurato • Izmērtais skaņas jaudas līmenis • Išmatuotas garso stiprumo lygis • Livell tal-Qawwa tal-Foss Iggarantit • Moc akustyczna mierzona • Nivel sonoro medido • Nivelul măsurat al puterii acustice • Nameraná hladina akustického výkonu • Izmerjena raven zvočne moči • Nivel de potencia sonora medido • Uppmätt ljudeffektnivå	86dB(A)Lwa
Guaranteed Sound Power Level • Гарантирано ниво на звукова мощност • Garantovaný akustický výkon • Garanteret lydstyrkeniveau • Geгарanteerd geluidsniveau • Garantiered helivõimsuse tase • Taattu äänitehotaso • Niveau de puissance sonore garanti • Garanterter Schalldruckpegel • Εγγυημένο επίπεδο ηχητικής ισχύος • Szavatolt hangteljesítményszint • Livello di potenza sonora garantito • Garantētais skaņas jaudas līmenis • Garantuotas garso stiprumo lygis • Livell tal-Qawwa tal-Foss Iggarantit • Moc akustyczna gwarantowana • Nivel sonoro farantido • Nivelul garantat al puterii acustice • Garantovaná hladina akustického výkonu • Zajamčena raven zvočne moči • Nivel de potencia sonora garantizado • Garanterad ljudeffektnivå	88 dB(A)Lwa
Conformity Assessment Procedure (Noise) • Оценка за съответствие на процедурата (Шум) • Postup hodnocení plnění podmínek (hluk) • Procedure for overensstemmelsesvurdering (Støj) • Procedure van de conformiteitsbeoordeling (geluid) • Vastavushindamismenetlus (müra) • Vaatimustenmukaisuuden arviointimenetely (Melu) • Procédure d'évaluation de conformité (bruit) • Konformitätsbeurteilungsverfahren (Geräusch) • Διαδικασία Αξιολόγησης Συμμόρφωσης (Θόρυβος) • Megfelelőség-értékelési eljárás (Zaj) • Procedura de valutatzone della conformità (rumore) • Atbilstības novērtējuma procedūra (troksnis) • Atitikties įvertinimo procedūra (garsas) • Procedura tal-Valutazzjoni tal-Konformità (Foss) • Procedura ocen y zgodności (poziom hałas) • Processo de avaliação de conformidade (nivel sonoro) • Procedura de evaluare a conformității (zgomot) • Postup vyhodnocovania zhodnosti (hluk) • Postopek za ugotavljanje skladnosti (hrup) • Procedimiento de evaluación de conformidad (ruido) • Procedur för bedömning av överensstämmelse (buller)	2000/14/EC Annex VI Part 1
UK Notified Body for 2000/14/EC • Нотифициран орган в Обединеното кралство за 2000/14/EO • Úřad certifikovaný podle směrnice č. 2000/14/EC • Det britiske bemyndigede organ for 2001/14/EF • Engels adviesorgaan voor 2000/14/EG • Ühendkuningriigi teavitatud asutus direktiivi 2000/14/EÜ mõistes • Direktiivin 2000/14/EY mukainen ilmoitettu tarkastuslaitos Isonsa-Britanniassa • Organisme notifié concernant la directive 2000/14/CE • Britische benannte Stelle für 2000/14/EG • Κοινοποιημένος Οργανισμός Ηνωμένου Βασιλείου για 2000/14/EK • 2000/14/EK - egyesült királyságbeli bejelentett szervezet • Organismo Notificato in GB per 2000/14/CE • 2000/14/EK AK registrētā organizācija • JK notifikuotais iestāgs 2000/14/EC • Korp Notifikat tar-Renju Unit għal 2000/14/KE • Dopuszczona jednostka badawcza w Wielkiej Brytanii wg 2000/14/WE • Entidade notificada no Reino Unido para 2000/14/CE • Organism notificat în Marea Britanie pentru 2000/14/CE • Notifikovaný orgán Spojeného královstva pre smernicu 2000/14/ES • Britanski prijavljeni organ za 2000/14/ES • Cuerpo notificado del Reino Unido para 2000/14/CE • Amelgħewil għall-2000/14/EC • Statistiska	Smithco West Inc. 200 West Poplar Avenue Cameron, WI 54822 USA
Operator Ear Noise Level • Оператор на нивото на доловим от ухото шум • Hladina hluku v oblasti uší operátora • Støjniveau i førers ørehøjde • Geluidsniveau oor bestuurder • Műratase operatortól kőrvas • Melutaso kăyttăjăn korvan kohdalla • Niveau de bruit à hauteur des oreilles de l'opérateur • Schallpegel am Bedienerohr • Επίπεδο θορύβου σε λειτουργία • A kezelő fülnél mért zajszint • Livello di potenza sonora all'orecchio dell'operatore • Trokšņa līmenis pie operatora auss • Dirbančiojo su mašina patiriama triukšmo lygis • Livell tal-Foss fil-Widna tal-Operator • Dopuszczalny poziom hałasu dla operatora • Nivel sonoro nos ouvidos do operador • Nivelul zgomotului la urechea operatorului • Hladina hluku pôsobiacia na sluch operátora • Raven hrupa pri užesu upravljavca • Nivel sonoro en el oído del operador • Ljudnivå vid förarens öra	86 dB(A)Lwa (2006/42/EC)

Reference



DECLARATION OF CONFORMITY

<p>Harmonised standards used • Използвани хармонизирани стандарти • Použité harmonizované normy • Brugte harmoniserede standarder • Gebuikte geharmoniseerde standaards • Kasutatud ühtlustatud standardid • Käytetyt yhdenmukaistetut standardit • Normes harmonisées utilisées • Angewandte harmonisierte Normen • Εναρμονισμένα πρότυπα που χρησιμοποιήθηκαν • Harmonizált szabványok • Standard armonizzati applicati • Izmanotie saskanotie standarti • Panaudoti suderinti standartai • Standards armonizzati užati • Normy spójne powiązane • Normas harmonizadas usadas • Standardele armonizate utilizate • Použité harmonizované normy • Uporabljeni usklajeni standardi • Estándares armonizados utilizados • Harmoniserade standarder som används</p>	<p>BS EN ISO 12100 BS EN ISO 13857 BS EN 3349: 1993+A1:2008 BS 6356: P8 BS 6356:P5 BS EN ISO 4254-6</p>
<p>Technical standards and specifications used • Използвани технически стандарти и спецификации • Použité technické normy a špecifikácie • Brugte tekniske standarder og specifikationer • Gebuikte technische standaards en specificaties • Kasutatud tehnilised standardid ja spetsifikatsioonid • Käytetyt tekniset standardit ja eritelmät • Spécifications et normes techniques utilisées • Angewandte technische Normen und Spezifikationen • Τεχνικά πρότυπα και προδιαγραφές που χρησιμοποιήθηκαν • Műszaki szabványok és specifikációk • Standard tecnici e specifiche applicati • Izmanotie tehničke standarti un špecifikācijas • Panaudoti techniniai standartai ir techninė informacija • Standards u specifickazzjonijiet teknici užati • Normy i specyfikacje techniczne powiązane • Normas técnicas e especificações usadas • Standardele tehnice și specificațiile utilizate • Použité technické normy a špecifikácie • Uporabljeni tehnični standardi in specifikacije • Estándares y especificaciones técnicas utilizadas • Tekniska standarder och specifikationer som används</p>	<p>2002/44/EC ISO 3767-1</p>
<p>The place and date of the declaration • Място и дата на декларацията • Místo a datum prohlášení • Sted og dato for erklæringen • Plaats en datum van de verklaring • Deklaratsiooni väljastamise koht ja kuupäev • Vakuutuksen paikka ja päivämäärä • Lieu et date de la déclaration • Ort und Datum der Erklärung • Τόπος και ημερομηνία δήλωσης • A nyilatkozat kelte (hely és idő) • Luogo e data della dichiarazione • Deklarācijas vieta un datums • Deklaracijos vieta ir data • Il-post u d-data tad-dikjarazzjoni • Miejsce i data wystawienia deklaracji • Local e data da declaração • Locul și data declarației • Miesto a dátum vyhlásenia • Kraj in datum izjave • Lugar y fecha de la declaración • Plats och datum för deklarationen</p>	<p>Smithco West Inc. 200 West Poplar Avenue Cameron, WI 54822 USA 15-Mar-18</p>
<p>Signature of the person empowered to draw up the declaration on behalf of the manufacturer, holds the technical documentation and is authorised to compile the technical file, and who is established in the Community. Подпис на човека, упълномощен да състави декларацията от името на производителя, който поддържа техническата документация и е оторизиран да изготви техническия файл и е регистриран в общността. Podpis osoby oprávněné sestavit prohlášení jménem výrobce, držet technickou dokumentaci a osoby oprávněné sestavit technické soubory a založené v rámci Evropského společenství. Underskrift af personen, der har fuldmagt til at udarbejde erklæringen på vegne af producenten, der er indehaver af dokumentationen og er bemyndiget til at udarbejde den tekniske journal, og som er baseret i nærområdet. Handtekening van de persoon die bevoegd is de verklaring namens de fabrikant te tekenen, de technische documentatie bewaart en bevoegd is om het technische bestand samen te stellen, en die is gevestigd in het Woongebied. Ühenduse registreeritud isiku allkiri, kes on volitatud tootja nimel deklaratsiooni koostama, kes omab tehnilisdokumentatsiooni ja kellel on õigus koostada tehniline toimik. Sen henkilöön allekirjoitus, jolla on valmistajan valtuutus vakuutuksen laadintaan, jolla on hallussaan teknisetasiakirjat, joka on valtuutettu laatimaan tekniset asiakirjat ja joka on sijoittautunut yhteisöön. Signature de la personne habilitée à rédiger la déclaration au nom du fabricant, à détenir la documentation technique, à compiler les fichiers techniques et qui est implantée dans la Communauté. Unterschrift der Person, die berechtigt ist, die Erklärung im Namen des Herstellers abzugeben, die die technischen Unterlagen aufbewahrt und berechtigt ist, die technischen Unterlagen zusammenzustellen, und die in der Gemeinschaft niedergelassen ist. Υπογραφή ατόμου εξουσιοδοτημένου για την σύνταξη της δήλωσης εκ μέρους του κατασκευαστή, ο οποίος κατέχει την τεχνική έκθεση και έχει την εξουσιοδότηση να ταξινομήσει τον τεχνικό φάκελο και ο οποίος είναι ιδιοκτήτης στην Κοινότητα. A gyártó nevében meghatalmazott személy, akinek jogában áll módosítania a nyilatkozatot, a műszaki dokumentációt őrizi, engedéllyel rendelkezik a műszaki fájllal összefüggésben, és aki a közösségben telepedett személy. Firma della persona autorizzata a redigere la dichiarazione a nome del fabbricante, in possesso dell' documentazione tecnica ed autorizzata a costituire il fascicolo tecnico, che deve essere stabilita nella Comunità. Tās personas paraksts, kura ir pilnvarota deklarācijas sastādīšanai ražotāja vārdā, kurai ir tehniskā dokumentācija, kura ir pilnvarota sagatavot tehnisko registru un kura ir apstiprināta Kopienā. Asmuo, kuris yra gana žinomas, kuriam gamintojas suteikė įgaliojimus sudaryti šią deklaraciją, ir kuris įjapaisa šį, turi visą techninę informaciją ir yra įgaliotas sudaryti techninės informacijos dokumentą. Il-firma tal-persuna awtorizzata li fassal id-dikjarazzjoni f'isem il-fabbrikant, ghandha d-dokumentazzjoniteknika u hija awtorizzata li tikkompila l-fajl tekniku u li hija stabbilita fil-Komunità. Podpis osoby upoważnionej do sporządzenia deklaracji w imieniu producenta, przechowującej dokumentację techniczną, upoważnioną do stworzenia dokumentacji technicznej oraz wyznaczonyj ds. wspólnotowych. Assinatura da pessoa com poderes para emitir a declaração em nome do fabricante, que possui a documentação técnica, que está autorizada a compilar o processo técnico e que está estabelecida na Comunidade. Semnătura persoanei împuternicite să elaboreze declarația în numele producătorului, care deține documentația tehnică, este autorizată să compileze dosarul tehnic și este stabilită în Comunitate. Podpis osoby poverenej vystavením vyhlásenia v mene výrobcu, ktorá má technickú dokumentáciu a je oprávnená spracovať technické podklady a ktorá je umiestnená v Spoločenstve. Podpis osebe, pooblaščené za izdelavo izjave v imenu proizvajalca, ki ima tehnično dokumentacijo in lahko sestavlja spis tehnične dokumentacije, ter ima sedež v Skupnosti. Firma de la persona responsable de la declaración en nombre del fabricante, que posee la documentación técnica y está autorizada para recopilar el archivo técnico y que está establecido en la Comunidad. Undertecknas av den som bemyndigad att upprätta deklarationen i tillverkarens vägnar, innehar den tekniskadokumentationen och är hemmahörad att sammanställa den tekniska informationen och som är etablerad i gemenskapen.</p>	<p>2006/42/EC Annex II 1A: 2 John Moore Sales, Director, Owner Moore Turf Care Thieplatz 4 49583 Lienen Germany 23-Sep-19</p> <p>2006/42/EC Annex II 1A: 10 Dawn Bryngelson Technical Documentation Advisor Smithco Inc. 34 West Avenue Wayne, PA USA 19087-3311 10-Dec-09</p>
<p>Certificate Number • Номер на сертификата • Číslo osvědčení • Certifikatnummer • Certificaatnummer • Sertifikaadi number • Hnyáksyntánumero • Numéro de certificat • Bescheinigungsnummer • Αριθμός Πιστοποιητικού • Hitelesítési szám • Numero del certificato • Sertifikáta numurs • Sertifikato numeris • Numru tač-Certifikat • Numer certifikatu • Número do Certificado • Număr certificat • Číslo osvědčenia • Številka certifikata • Número de certificado • Certifikatsnummer</p>	<p>305002023-1</p>

GB English	BG български	CZ čeština	DK dansk	NL Nederlands	EE eesti	FI suomi	FR français	DE Deutsch	GR Ελληνικά	HU magyar
IT italiano	LV latviešu valoda	LT lietuvių kalba	MT Malti	PL polski	PT português	RO Română	SK slovenčina	SI slovenščina	ES español	SE Svenska

QUICK REFERENCE

REPLACEMENT FILTERS

30-424	Hydraulic Oil Filter Assembly
30-424-01	Replacement Element
32-521-07	Primary Air Filter
32-521-08	Secondary Air Filter
13-488	Key Switch
32-521-04	In-line Fuel Filter Assembly
32-521-05	Muffler Gasket
32-521-10	Tailpipe Gasket

REPLACEMENT BELTS

30-432	Spray Pump V-Belt
30-042-11	Fan Belt

SEAL KITS

34-103	Power Steering Orbital Motor
15-301-01	Seal Kit
15-839	Hydraulic Cylinder (steering)
15-839-01	Seal Kit
13-406	Boom Actuators
14-267	Seal Kit
15-984	Hypro Pump
16-967	Seal Kit
30-099	Auburn Wheel Drive
30-099-01	Seal Kit
30-100	Disc Brake
30-100-01	Lining Kit
30-100-02	O-ring Kit
30-100-03	Bearing Kit
30-101	Wheel Motors
30-101-11	Seal Kit
30-423	Hydrostatic Pump
33-058-01	Seal Kit
76-197	Gear Pump
76-197-08	Seal Kit

FLUIDS

Engine Oil	SAE 10W-40 API Service SJ or higher Motor Oil
Hydraulic Fluid	SAE 10W-40 API Service SJ or higher Motor Oil
Radiator	1.06 Gal 50/50 Antifreeze/water mixture

OTHER PARTS

15-818	#75 Fitting O-ring
15-817	#50 Fitting O-ring
16-220	Cover On Spray Tank

The Smithco Commercial Products Two-Year Limited Warranty

Smithco, Inc. (Smithco) warrants your 2016 or newer Smithco Commercial Product (“Product”) purchased after October 1, 2016 to be free from defects in materials or workmanship for the period of time listed below. Where a warrantable condition exists, Smithco will repair the Product at no cost to you including diagnosis, labor (at the Smithco standard labor rate, subject to the Smithco flat rate schedule), and parts.

Warranty Duration is:

- (1) Two years, 1500 operational hours* from the date of delivery to the original purchaser or Five years from the date of original manufacturer of the product, whichever occurs first. (*Products equipped with hour meter).
- (2) Products used in rental situations are covered for 90 days from date of delivery to original user/renter.

Owner Responsibilities:

As the Product owner, you are responsible for required maintenance and adjustments stated in your Owner’s Manual. Failure to perform required maintenance and adjustments can be grounds for disallowing a warranty claim. **You are particularly responsible to train all present and future operators of this product on the safe operation of this product at your location.**

Instructions for Obtaining Warranty Service:

You are responsible for notifying the Authorized Smithco Products Distributor from whom you purchased the Product as soon as you believe a warrantable condition exists and not later than 30 days from discovery of the condition.

If you need help locating an Authorized Smithco Distributor, or if you have questions regarding your warranty rights or responsibilities, you may contact us at:

Smithco Product Support Department
200 West Poplar Ave.
Cameron, Wisconsin 54822
Telephone: 800-891-9435 E-Mail: ProductSupport@Smithco.com

Maintenance Parts:

Parts scheduled for replacement as required maintenance (“Maintenance Parts”), are warranted for the period of time up to the scheduled replacement time for that part.

Items/Conditions Not Covered:

Not all product failures or malfunctions that occur during the warranty period are defects in materials or workmanship. The items/conditions listed below are not covered by this warranty:



Product failures which result from the use of non-Smithco replacement parts, or from installation and use of add-on, modified, or unapproved accessories are not covered.



Product failures which result from failure to perform required maintenance and/or adjustments are not covered.



Product failures that result from operating the Product in an abusive, negligent or reckless manner are not covered.



This warranty does not apply to parts subject to consumption through use, unless found to be defective. Examples of parts which are consumed, or used up, during normal Product operation include, but are not limited to: blades, tines, teeth, scarifiers, rakes, plates, wear plates, castor wheels, tires, batteries, filters, belts, nozzles, etc.



This warranty does not apply to failures caused by outside influence. Items considered to be outside influence include, but are not limited to, weather, storage practices, contamination, use of unapproved coolants, lubricants, additives, or chemicals, etc.



This warranty does not apply to normal “wear and tear” items. Normal “Wear and Tear” includes, but is not limited to, damage to seats due to wear or abrasion, worn painted surfaces, scratched decals or windows, etc.



Smithco may require the return of failed parts or components in order to determine the validity of any warranty claim.



Smithco will not be obligated to replace components of other manufacturers if inspection by the original component manufacturer indicates that failure was due to normal wear and tear, expected consumption through use or improper care or service.

Other Legal Disclaimers:

The above remedy for product defects through repair or replacement by an authorized Smithco distributor or dealer is the purchaser’s sole remedy for any defect. This warranty gives you specific legal rights, and you may also have other rights which vary from state to state.

THERE ARE NO OTHER EXPRESS WARRANTIES OTHER THAN THOSE SET FORTH ABOVE. ALL IMPLIED WARRANTIES OF MERCHANTABILITY AND FITNESS FOR USE ARE LIMITED TO THE DURATION OF THE LIMITED WARRANTIES CONTAINED HEREIN.

Some states may not allow limitations on how long an implied warranty lasts, so the above limitation may not apply to you.

THE SMITHCO COMPANY IS NOT LIABLE FOR INDIRECT, INCIDENTAL OR CONSEQUENTIAL DAMAGES IN CONNECTION WITH THE USE OF THE PRODUCT, INCLUDING ANY COST OR EXPENSE OF PROVIDING A SUBSTITUTE PRODUCT OR SERVICE DURING PERIODS OF MALFUNCTION OR NON-USE.

Some states may not allow the exclusion of indirect, incidental or consequential damages, so the above exclusion may not apply to you.

Smithco neither assumes, nor authorizes any person to assume for it, any other liability in connection with the sale or use of this product.

