



# SPRAY STAR 1110

1101 Manual System

1102 Radion 8140

1104 TeeJet 744

1105/1108 Star Command I

1115-AG/1118-AG Star Command II

**Product Support:**

**Hwy 55 & Poplar Ave; Cameron WI 54822**

**1-800-891-9435    [productsupport@smithco.com](mailto:productsupport@smithco.com)**

# CONTENTS

<b>Introduction .....</b>	<b>1-10</b>
Introduction .....	1
Symbols .....	2
Safety .....	3
Safety Decals .....	4
General Safe Practices .....	5
Safe Spraying Practices .....	6
Specifications .....	7
Optional Spray Equipment .....	7
Set Up .....	8
Controls & Instruments.....	9-10
<b>Operation .....</b>	<b>11-14</b>
Operating Instructions .....	11-12
Tank Agitation .....	13
Sprayer Cleaning .....	13-14
<b>Diagrams.....</b>	<b>15-16</b>
Wiring Diagram .....	15
Hydraulic Diagram.....	16
<b>Reference.....</b>	<b>17-20</b>
Declaration of Conformity.....	17-18
Quick Reference .....	20

Thank you for purchasing a **Smithco** product.

Read this manual and all other manuals pertaining to the **Spray Star 1110** carefully as they contain safety, operating, assembly and maintenance instructions. Failure to do so could result in personal injury or equipment damage.

Keep manuals in a safe place after operator and maintenance personnel have read them. Right and left sides are from the operator's seat, facing forward.

## WARNING

*Failure to follow cautious operating practices can result in serious injury to the operator or other persons. The owner must understand these instructions, and must allow only trained persons who understand these instructions to operate this vehicle.*

All **Smithco** machines have a Serial Number and Model Number. Both numbers are needed when ordering parts. The serial number plate on the **Spray Star 1110** is located on the right hand frame rail. Refer to engine manual for placement of engine serial number. Refer to engine manual for placement of engine serial number.

For product and accessory information, help finding a dealer, or to register your product please contact us at [www.Smithco.com](http://www.Smithco.com).

Information needed when ordering replacement parts:

1. Model Number of Machine
2. Serial Number of machine
3. Name and Part Number of part
4. Quantity of parts

For easy access record your Serial and Model numbers here.

Model Number: \_\_\_\_\_

Serial Number: \_\_\_\_\_

Date of Purchase: \_\_\_\_\_

**SMITHCO CUSTOMER SERVICE 1-800-891-9435**



# SYMBOLS

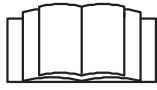

Read Operator's Manual



Engine Stop



Engine Start



Engine Run

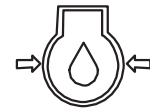

Engine Oil

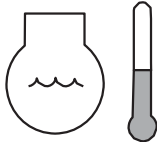

Water Temperature



RPM



Gasoline



Diesel



Glow Plug



Hour Meter



Hand Throttle



Choke

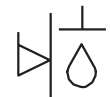

Hydraulic Oil Level



Ground Speed



Park Brake



Park Brake Release



Fast



Slow



Lift Arm

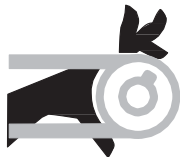

Moving Parts



Pinch Point



Hot Surface



Hydraulic Fluid Penetration



No Riders

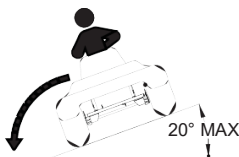

Rollover Danger

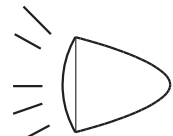

Headlamp

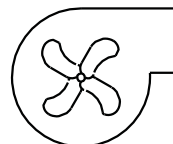

Blower



Warning Danger



Seat Belt

## SAFETY WARNINGS

Read and understand this manual and all safety signs before operating and maintaining. Review the safety instructions and precautions annually.

**TAKE NOTE! THIS SAFETY ALERT SYMBOL FOUND THROUGHOUT THIS MANUAL IS USED TO CALL YOUR ATTENTION TO INSTRUCTIONS INVOLVING YOUR PERSONAL SAFETY AND THE SAFETY OF OTHERS. FAILURE TO FOLLOW THESE INSTRUCTIONS CAN RESULT IN INJURY OR DEATH**



### Safety Alert Symbol

This symbol with a warning statement means:

**WARNING! BE ALERT!**

**YOUR SAFETY IS INVOLVED!**

Carefully read the message that follows

### SAFETY SIGNAL WORDS

Note the use of the signal words DANGER, WARNING and CAUTION with the safety messages. The appropriate signal word for each has been selected using the following guidelines:



**DANGER**

**DANGER:** Red. Indicates an imminently hazardous situation that, if not avoided, will result in death or serious injury. This signal word is to be limited to the most extreme situations typically for machine components which, for functional purposes, cannot be guarded.



**WARNING**

**WARNING:** Orange. Indicates a potentially hazardous situation that, if not avoided, could result in death or serious injury, and includes hazards that are exposed when guards are removed. It may also be used to alert against unsafe practices.



**CAUTION**

**CAUTION:** Yellow. Indicates a potentially hazardous situation that, if not avoided, may result in minor or moderate injury. It may also be used to alert against unsafe practices.



**IMPORTANT**

**IMPORTANT:** Blue. Indicates procedures which should be followed to avoid damage to the machine.



## SAFETY DECAL LOCATION



**REMEMBER: If Safety Decals\*\* have been damaged, removed, become illegible or parts replaced without decals, new decals must be applied. New decals are available from your authorized distributor or factory.**

**THIS IS A LIST OF DECALS LOCATED ON THE SPRAY STAR 1110. PART NUMBER, DESCRIPTION AND LOCATION WILL HELP IN REORDERING A DECALS.**

A	10-743	Decal, Spray Star 1110
B	25-356	Decal, Tire Pressure 20psi
C	25-352	Decal, Bypass Valve
D**	25-298	Decal, Warning Hot
E	15-719	Decal, Speed Control
F**	27-093	Decal, Oil Level
G	25-370	Decal, 88 dba
H**	15-463	Decal, Spray Pump </td
I	25-373	Decal, Smithco
J**	10-657	Decal, Control Panel
K**	25-277	Decal, Battery Warning
L**	14-803	Decal, Clean Agitation Strainer

\*\* Safety Decals Required

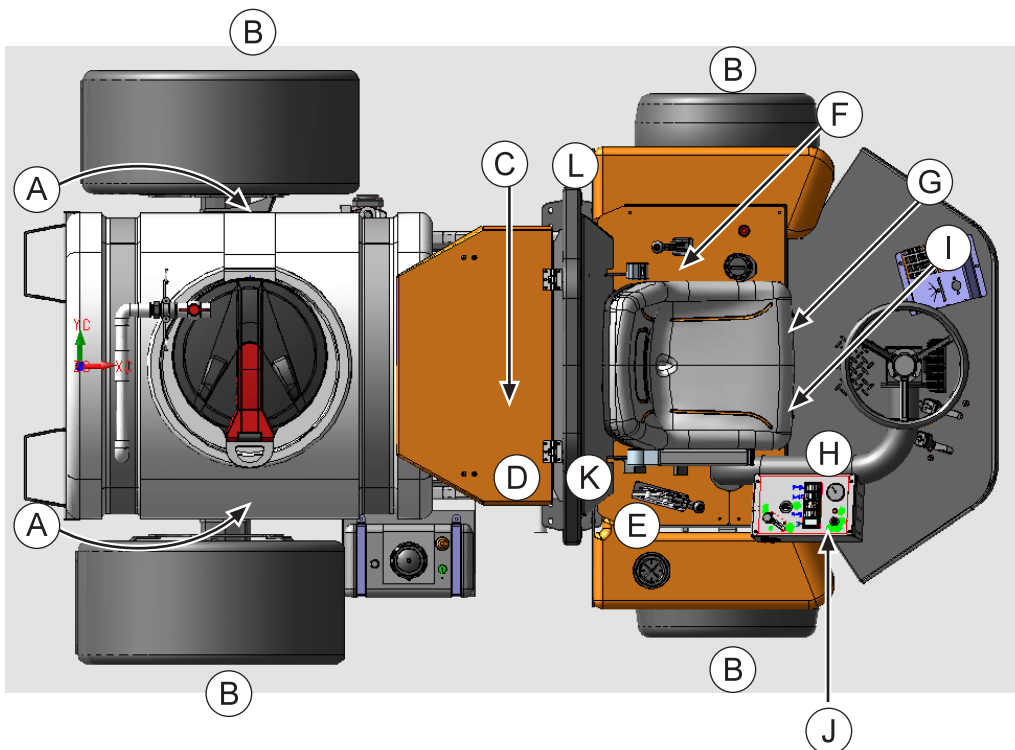

1. It is your responsibility to read this manual and all publications associated with this machine.
2. Never allow anyone to operate or service the machine or its optional equipment without proper training and instructions. Never allow minors to operate any equipment.
3. Learn the proper use of the machine, the location and purpose of all the controls and gauges before you operate the equipment. Working with unfamiliar equipment can lead to accidents.
4. Wear all the necessary protective clothing and personal safety devices to protect your head, eyes, ears, hands and feet. Operate the machine only in daylight or in good artificial light.
5. Inspect the area where the equipment will be used. Pick up all debris you can find before operating. Beware of overhead obstructions and underground obstacles. Stay alert for hidden hazards.
6. Never operate equipment that is not in perfect working order or without decals, guards, shields, or other protective devices in place.
7. Never disconnect or bypass any switch.
8. Carbon monoxide in the exhaust fumes can be fatal when inhaled, never operate a machine without proper ventilation.
9. Fuel is highly flammable, handle with care. When filling tank stop 1 inch(2.54 cm) from top. Leave room for expansion. **DO NOT OVERFILL.**
10. Keep engine clean. Allow the engine to cool before storing and always remove the ignition key.
11. Disengage all drives and set park brake before starting the engine.
12. Never use your hands to search for oil leaks. Hydraulic fluid under pressure can penetrate the skin and cause serious injury.
13. This machine demands your attention. To prevent loss of control or tipping of the vehicle:
  - A. Use extra caution in backing up the vehicle. Ensure area is clear.
  - B. Do not stop or start suddenly on any slope.
  - C. Reduce speed on slopes and in sharp turns. Use caution when changing directions on slopes.
  - D. Stay alert for holes in the terrain and other hidden hazards.
14. Before leaving operator's position:
  - A. Disengage all drives.
  - B. Set park brake.
  - C. Shut engine off and remove the ignition key.
  - D. If engine has to run to perform any maintenance keep hands, feet, clothing and all other parts of body away from moving parts.
15. Keep hands, feet and clothing away from moving parts. Wait for all movement to stop before you clean, adjust or service the machine.
16. Keep the area of operation clear of all bystanders.
17. Never carry passengers.
18. Stop engine before making repairs/adjustments or checking/adding oil to the crankcase.
19. Use parts and materials supplied by **Smithco** only. Do not modify any function or part.
20. Use caution when booms are down as they extend out beyond the center line of the machine.
21. The spray tank is a confined space, take precaution.

***These machines are intended for professional maintenance on golf courses, sports turf, and any other area maintained turf and related trails, paths and lots. No guarantee as to the suitability for any task is expressed or implied.***



# SAFE SPRAYING PRACTICES

Persons engaged in the handling, preparation or application of chemicals must follow accepted practices to insure the safety of themselves and others,

1. **WEAR** protective clothing including: gloves, hat, respirator, eye protection and skin covering suitable for protection from chemicals being used.
2. **BATHE** thoroughly after any exposure to chemicals, giving particular attention to eyes, nose, ears and mouth.
3. **CLEAN** equipment and materials in accordance with employer, municipal and state regulations. Use only approved areas and drains.
4. **DISPOSE** of chemicals and rinse solutions by approved and legal means.
5. **PROVIDE** methods and materials for operators to wash eyes and hands immediately during the spraying process.
6. **PROVIDE** methods and materials for control, safe dilution and neutralization of chemical spills during preparation, spraying, transporting and cleanup.
7. Always check and follow the directions and safety warnings of the chemicals to be used.
8. Secure the discharge lines before starting the pump. An unsecured discharge line may whip.
9. Periodically inspect the pump and the system components.
10. Check hoses for weak or worn condition before each use. Make certain that all connections are tight and secure.
11. Do not operate unit with leaks, frayed, kinked hoses or tubing. Repair or replace immediately.
12. Use only pipe, hose and fittings rated for maximum pressure or pressure at which pressure relief valve is set at. When replacing pipe, hose or fittings, use new product.
13. Do not operate a gasoline engine in an enclosed area. Be sure the area is well ventilated.
14. Do not use these pumps for pumping water or other liquids for human or animal consumption.
15. **Do not pump flammable or explosive fluids such as gasoline, fuel oil, kerosene, etc.**  
**Do not use in explosive atmospheres. The pump should be used only with liquids compatible with the pump component materials.**
16. Be sure all exposed moving parts are guarded and that all coupling devices are securely attached before applying power.
17. Before servicing, disconnect all power, make sure all pressure in the system is relieved, drain all liquids from the system and flush.
18. Protect pump from freezing conditions by draining liquid and pumping rust inhibiting antifreeze solution through the system, coating the pump interior.
19. **TRANSPORT** - Machine **must be stopped** to raise or lower booms. Because of cam system, if booms are raised in transit they can fall forward or backward when coming to a stop or while traveling on uneven terrain.
20. **IMPORTANT** If using Simulated Speed with a Radion 8140, one needs to change back to Ground Speed for proper rate control when spraying.

 **WARNING**

 **IMPORTANT**





# SPECIFICATIONS SPRAY STAR 1110

## WEIGHTS AND DIMENSIONS

Length	130" (3.30m) with Boom	117" (2.97m) without Boom
Width	71" (1.8m)	
Height With 18' Boom	84" (2.1m)	
Height	75" (1.9m)	
Wheel Base	56" (1.4m)	
Weight Empty	1676lbs (760 kg)	
Weight Full	2592lbs (1175 kg)	

## SOUND LEVEL (DBA)

At ear level	84.5 dba
--------------	----------

## ENGINE

Make	Briggs & Stratton
Model#	386447
Type / Spec#	0459 G1
Horsepower	23HP (17 kw)
Fuel	Unleaded 87 Octane Gasoline Minimum
Cooling System	Air Cooled
Lubrication System	Full Pressure
Alternator	25 Amp

## WHEELS & TIRE

Front:	Two 20 x 10.00 x 10 NHS Smooth; 20psi (1.4 bar)
Rear:	Two 24 x 13.00 x 12 NHS Multi-Trac; 20psi (1.4 bar)
	Hand Operated Lever, Discs on Rear Axle

## PARK BRAKE

## SPEED

Forward Speed	0-8 mph (0-12.8 kph)
Reverse Speed	0-3 mph (0-4.8 kph)

## BATTERY

	Automotive type 24F-12 Volt
BCI Group	Size 24
Cold Cranking Amps	575 minimum
Ground Terminal Polarity	Negative (-)
Maximum Length	10.25" (26 cm)
Maximum Width	6.88" (17 cm)
Maximum Height	10" (25 cm)

## FLUID CAPACITY

Crankcase Oil	See Engine Manual
Fuel	6 gallon (22.7 liters)
Hydraulic Fluid	5 gallon (19 liters)
Grade of Hydraulic Fluid	SAE 10W-40 API Service SJ or higher Motor Oil

# OPTIONAL EQUIPMENT

10-417	Chemical Clean-load Safe Fill System	17-601	15' Heavy Duty Boom
15-968	20Gal. Wash System	17-585	18' Heavy Duty Boom
30-006	Fresh Water Tank	1104	TeeJet 744 Spray System
15-835	Tank Rinsing System	1102	Radion 8140 Spray System
10-821	Water Meter Kit	1101	3-Way Manual System
15-965	Foam Marker	1105/1108	DynaJet/Radion Spray System
15-622	Canopy	1115-AG/1118-AG	Star Comand II Spray System
15-967	Hose Reel Mount Kit		
16-129	Manual Rewind Hose Reel, 200-foot/61-meter capacity		
16-906	Electric Rewind Hose Reel, 200-foot/61-meter capacity		



## SETUP

The Spray Star 1110 arrives from **Smithco** setup and ready for service. Depending on freight conditions the battery may have to be installed.

The spray system is normally shipped attached to the Prime Mover. If a spray system is to be fitted to a Prime Mover by a dealer or end user, assemble and attach the components in accordance with the parts drawings in the *Spray Star 1110 Parts/Service Manual*.

1. Check the tire pressure. The front are 20 psi (1.4 bar) and rear tires are 18 psi (1.3 bar).
2. Battery is located behind the right front wheel.

### ⚠ WARNING

**Connecting battery cables to the wrong post could result in personal injury and/or damage to the electrical system. Make sure battery and cables do not interfere or rub on**

**any moving part. Connect red positive (+) cable (A) to battery first. When disconnecting remove black negative (-) cable (B) first.**

3. Check hydraulic fluid level in tank located on the left side of the seat. Remove cap and add SAE 10W-40 API Service SJ or higher motor oil if necessary. Fluid level should be about 2-2 $\frac{1}{2}$ " (5-6.4 cm) from the top of the tank when cold. **DO NOT OVERFILL.**
4. Fill fuel tank, located on the right side, with Unleaded 87 Octane gasoline (minimum). When filling the fuel tank stop when the fuel reaches 1 inch (2.54cm) from the top. This space is necessary for fuel expansion. **DO NOT OVERFILL.**

### ⚠ DANGER

**Fuel is flammable, caution must be used when storing or handling it. Do not fill fuel tank while engine is running or an enclosed area, fumes are explosive and dangerous to inhale. DO NOT SMOKE while filling the fuel tank. DO NOT OVERFILL.**

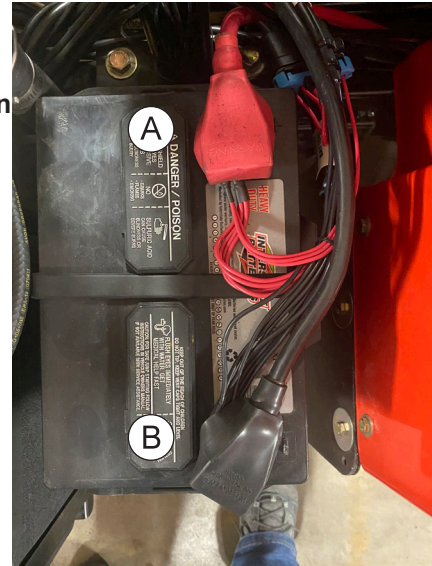

5. Machine should be greased before starting, refer to *Spray Star 1110 Parts/Service Manual* for location.
6. Attach the Spray Boom and any other Optional Equipment to the Prime Mover, in accordance with instructions in the *Spray Star 1110 Parts/Service Manual*. The nozzles must be the correct distance above the turf as described in *Turf Spraying Guide*. The spray boom must operate properly and the outer sections must break away safely if an object is struck by them, they must then return to normal operation position.
7. Be sure to double check boom heights, nozzle spacing and displacement before spraying.
8. Machine is shipped with windshield washer fluid in Spray System to prevent freezing. Flush system completely with clear water. Fill tank with water and re-tighten the four bolts used to hold the tank in place.
9. Read operating instructions before starting.

### ⚠ IMPORTANT

**Never allow pump to run dry! The valve on the suction side of the pump (between the pump and tank) must be fully open whenever the pump is operated.**



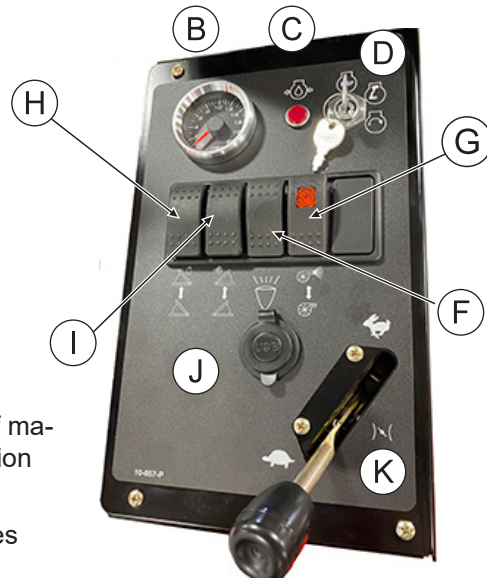

- A. Hour Meter - The hour meter indicates hours of machine operation. It operates only when the ignition switch is on.
- B. GPS Speedometer - The Speedometer indicates ground speed of the vehicle in miles per hour.
- C. Oil Light - The oil light should come on when the ignition is on without the engine running and go out when the engine is running. The oil light will light when the oil pressure is low. If oil light should come on, shut engine off immediately and find the cause.
- D. Ignition Switch - The ignition switch has three positions: Off - Run - Start.
- E. Buzzer - The buzzer sounds if the pump is running dry.
- F. Lights - This rocker switch turns lights on by pushing on the top and off by pushing on the bottom.
- G. Spray Pump - This rocker switch turns the spray pump on by pushing on the top and off by pushing on the bottom.
- H. Left Boom Switch - This rocker switch lifts and lowers the left boom.
- I. Right Boom Switch - This rocker switch lifts and lowers the right boom.
- J. Dual USB Charging Port - lets you charge your cell phone, tablet, or other device.
- K. Hand Throttle - The hand throttle is used to regulate engine speed.
- L. GNSS Antenna Switch - (Optional) Used to turn on/off GNSS Antenna, used with spray systems.

## SPEEDOMETER

This machine is equipped with a GPS Speedometer. **Please note** that if the speedometer has been powered off longer than 4 hours, it could take up to 1 minute to acquire signal due to the satellites moving significantly from your location. **This is normal.** The current draw is extremely low and will have virtually zero impact on a battery's charge. Hot start wire should be connected directly to battery +12volts and should remain powered 100% of the time. When GPS gauge first receives power, the needle will sweep full counter clockwise towards

0 mph. Pointer will stay at 0 mph and oscillate slightly at zero to indicate the GPS is acquiring satellites. GPS is **not yet** functional to indicate speed. Once satellites are acquired (15-45 seconds), the pointer will swing full scale and then back toward 0 mph to indicate it is now ready for operation.



## CONTROLS & INSTRUMENTS

- M. Choke - The choke is used in starting the engine. Pull choke out to close choke plate when starting a cold engine. Push in when engine starts. A warm engine may not require "choking" to start.
- N. Spray Boss Control - Engages and disengages speed boss. Forward is engage and all the way back is disengage. When the lever is engaged it sets a stop for the accelerator. The accelerator pedal must be used to maintain this speed. To adjust speed use the knob on the end of the lever, counter clockwise increases speed and clockwise decreases speed. Disengage the lever and you will have full accelerator pedal range.
- O. Park Brake - The park brake is only a parking brake. Pull back to release, push forward to apply. Some adjustment can be made by turning the knob clockwise to tighten and counter clockwise to loosen.
- P. Reverse Pedal - This pedal controls ground speed in the reverse direction. Press the pedal to reverse direction. Varying the amount of movement of the pedal will vary the ground speed.
- Q. Accelerator Pedal - This pedal controls ground speed. Press pedal to increase speed. Varying the amount of movement of the pedal will vary the ground speed.

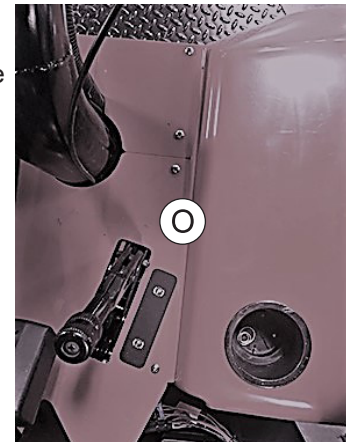
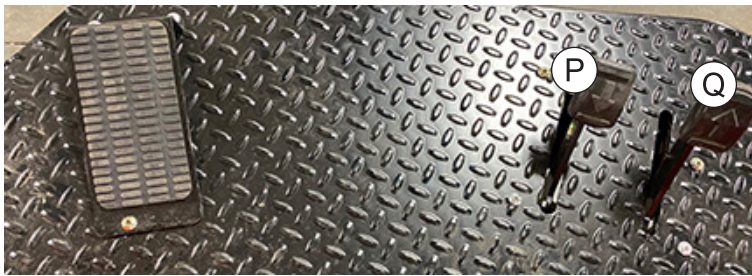

### MASTER BOOM SWITCH

The master boom switch (R), if required, is located on the left floorboard. It is used to override the master switch on the computer console of the **Radion Spray Systems**. By pushing down it will turn on/off the booms. For *TeeJet Systems*, the master switch on the computer **must be on**.



Before operating the Spray Star 1110, become familiar with all controls and functions. Also complete all maintenance requirements and read all safety warnings. Knowing the Spray Star 1110 thoroughly, how it operates, and by doing the prescribed maintenance steps, you can expect trouble free operation for years to come.

## SAFETY

Safety needs to always be the concern of an operator of a moving vehicle or any machine with moving parts.

1. Keep all shields and guards in place.
2. Keep the parking brake engaged any time the operator is away from the vehicle or whenever service is performed.
3. Always wear the necessary protective clothing and equipment.
4. Turn engine off when refueling or performing maintenance not specifically requiring engine power.

## DAILY CHECKLIST

1. Check the engine oil level. Add as needed. **DO NOT OVERFILL.** Refer to engine owner's manual for oil grade and procedure.
2. Tire pressure should be 20 psi (1.4 bar) maximum.
3. Inspect the electrical system and battery cables for loose connections or frayed wiring. Replace any faulty equipment or tighten if loose.
4. Check hardware for loose or missing nuts, bolts, screws, etc., and tighten or replace as needed.
5. Inspect hydraulic lines for damage or leaks. Never use hands to inspect for leaks.
6. Check the hydraulic fluid level. The hydraulic fluid tank is located on the left side of the seat. The fluid level should be 2"-2½" (5 - 6.4 cm) from the top of the tank when cold. Use only SAE 10W-40 API Service SJ or higher Motor Oil.
7. Inspect the steering, throttle and shift linkages for good hookups and clear travel.
8. Check controls for smooth, proper working operation. Lubricate as needed.
9. Check park brake adjustments. Adjust as required.
10. Check anti-vibration mounts on engine frame.

## STARTING THE ENGINE

1. The ignition switch is located on the dashboard. Insert the key (A) and turn clockwise until the engine starts (C). Release the key and it will return to the run position (B). Use the choke and hand throttle as necessary.
2. Allow engine to idle and warm up before selecting direction of travel.

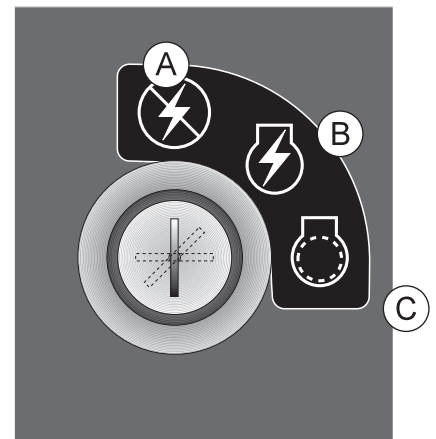

## STOPPING THE ENGINE

### ⚠ IMPORTANT

If the engine has been running under high power, let it run at slow idle speed a few minutes to cool the engine down, before turning the ignition switch to the OFF position.

1. Disengage spray pump.
2. Move the throttle lever to "slow" and turn ignition key to the "off" position.
3. Remove the ignition key and engage the park brake.

### ⚠ CAUTION

Never leave the vehicle unattended with the engine running. Always bring the vehicle to a complete stop, engage park brake, turn key off and remove key.

## OPERATION (CONTINUED)

Before using the Spray Star, the operator and spray technician must familiarize themselves with all of the information on chemical spraying contained in the *Turf Spray Guide*.

### IMPORTANT

**All testing and calibrating of sprayers is to be done with water, not chemicals. This insures the safety to all involved in performing the calibration operation. Only after all calibration procedures are completed should chemical be added to the sprayer.**

### TOWING UNIT

When it is necessary to move the Spray Star 1110 without the engine running, the bypass valve built into hydrostatic pump must be "open" by turning it counterclockwise. The valve is located on the bottom of the pump. An "open" valve allows fluid to pass through the wheels freely. When normal driven operation is desired, valve should be "closed" by turning it clockwise. Failure to "close" the valve with engine running means no power to wheels.

### HILLSIDE OPERATION

Do NOT stop or start suddenly on any slope. Be especially cautious when changing direction. Do NOT operate on slopes greater than 20°.

### BATTERY

Batteries normally produce explosive gases which can cause personal injury. Do not allow flames, sparks or any ignited object to come near the battery. When charging or working near battery, always shield your eyes and always provide proper ventilation.

Battery cable should be disconnected before using "Fast Charge".

Charge battery at 15 amps for 10 minutes or 7 amps for 30 minutes. Do not exceed the recommended charging rate. If electrolyte starts boiling over, decrease charging.

Always remove grounded (-) battery clamp first and replace it last. Avoid hazards by:

1. Filling batteries in well-ventilated areas.
2. Wear eye protection and rubber gloves.
3. Avoid breathing fumes when electrolyte is added.
4. Avoid spilling or dripping electrolyte.

### WARNING

**Battery Electrolyte is an acidic solution and should be handled with care. If electrolyte is splashed on any part of your body, flush all contact areas immediately with liberal amounts of water. Get medical attention immediately.**

### JUMP STARTING

### WARNING

**Use of booster battery and jumper cables. Particular care should be used when connecting a booster battery. Use proper polarity in order to prevent sparks.**

To jump start (negative grounded battery):

1. Shield eyes.
2. Connect ends of one cable to positive (+) terminals of each battery, first (A) then (B).
3. Connect one end of other cable to negative (-) terminal of "good" battery (C).
4. Connect other end of cable (D) to engine block on unit being started (NOT to negative (-) terminal of battery)

To prevent damage to other electrical components on unit being started, make certain that engine is at idle speed before disconnecting jumper cables.

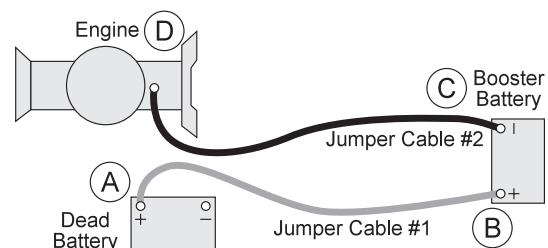

## SPRAYER VALVE SETTINGS AND SPRAY TANK AGITATION

The 3-way valve on the suction side of the pump, between the tank and the pump must be open before pump is engaged. Close this valve only when necessary to clean the filter with spray material in the spray tank.

There is one manual flow control valve on the discharge side of the spray system. This valve controls the agitator. This valve may be opened as much as necessary to provide hydraulic agitation through the quadra-jet agitator in the tank bottom. This valve may be partially closed to prevent or reduce foam buildup from the spray materials inside the tank. When the liquid level in the spray tank reaches a certain level (usually 1-25 gallons (3.8-95 Liters) depending on terrain and other conditions) it may be necessary to close the valve in the agitator line in order to prevent loss of suction prime.

If your Spray Star is fitted with a hose reel, there is a second ball valve on the discharge system to supply material to the hose reel.

The Quadrajet agitation system operates with four venturi jets in the tank bottom. These jets have replaceable orifice discs which discharge the following amounts of spray material.

Nozzle Diameter	Input to Agitator in gpm	Input to Agitator in L/min	Agitator Pressure in psi	Agitator Pressure in bar	Agitator Output in gpm	Agitator Output in L/min
1/8"	1.9	7.2	25	1.7	6.3	23.8
1/8"	2.7	10.2	50	3.4	10.0	37.9
1/8"	3.8	14.4	100	6.9	15.0	56.8
5/32"	2.8	10.6	25	1.7	7.6	28.8
5/32"	4.2	15.9	50	3.4	12.2	46.2
5/32"	5.5	20.8	100	6.9	17.5	66.2
3/16"	3.6	13.6	25	1.7	9.1	34.4
3/16"	5.6	21.2	50	33.4	14.3	54.1
3/16"	7.9	29.9	100	6.9	18.7	70.8

You can change orifice disc sizes to enhance spray system performance. Smaller discs reduce amount of agitation (desirable in some foaming materials) and make more discharged liquid available for nozzles. Larger (or none) discs increase amount of agitation and make less discharged liquid available for nozzles.



# SPRAYER CLEANING

One of the most common causes for faulty-pump performance is corrosion inside the pump. Flush the pump and entire system with a solution that will chemically neutralize the liquid pumped. Mix according to manufacturer's directions. This will dissolve most residue remaining in the pump, leaving the inside of the pump clean for the next use.

## TO PREVENT CORROSION

After cleaning the pump as directed, flush it with a permanent type automobile antifreeze (Prestone, Zerex, etc.) containing a rust inhibitor. Use a 50% solution that is, half antifreeze and half water. Then coat the interior of the pump with a substance which will prevent corrosion such as Fluid Film or WD40. If unit will not be used for an extended period of time, disconnect hoses into and out of the pump, seal openings to the pump with caps or tape. Dispose of fluids according to all federal, state and local regulations.

### IMPORTANT

**All chemicals and chemical residue must be removed after each use. Dispose of fluids and residue according to all federal, state and local regulations.**

## SPRAYER CLEANING

Empty tank and clean unit thoroughly after each use following these instructions:

1. Turn off 3-way valve and rinse inside of tank thoroughly with clean water, remove cap from valve to drain.
2. Fill tank ten percent full with clean water, Turn 3-way valve on and start pump and discharge water through spray hose or spray boom (with nozzles removed), until empty.
3. Turn off 3-way valve again and rinse tank interior thoroughly. Remove cap from 3-way valve to drain.
4. Rinse exterior of sprayer thoroughly with clean water.
5. This sprayer is equipped with a self cleaning strainer. The strainer uses the excess pump flow to bypass clogging particles back to the spray tank. There is a gap between the tapered inner cylinder and the screen face that causes the inlet fluid to flow at a high velocity past the screen face providing a continuous wash down of particles. For this wash down to occur a minimum of +GPM/23 l/min is required through the bypass line.

## AGITATION LINE STRAINER CLEANING

Agitation line strainer is located below the sprayer filter. This strainer catches impurities that go to the turbo-jet agitation system in the spray tank. It has a quick disconnect pin on it to remove the bowl. **After EVERY use**, remove bowl and clean screen. Replace screen as needed. We recommend a 50 Mesh screen.

## MANUAL HOSE REEL

Located at the back of the Spray Star on top of the tank. Open the ball valve located near the manifold valve to allow fluid to flow into the hose reel. Place the lockout pin in the unlocked position by pulling and turning it half a turn, this will allow you to pull out additional hose or to use the handle and wind up the hose. To prevent movement during transport or storage place the lockout pin in the locked position.

## ELECTRIC HOSE REEL

Located at the back of the Spray Star on top of the tank. Open the ball valve located near the manifold valve to allow fluid to flow into the hose reel. To unwind hose just pull on the hose to get the desired amount. To wind up the hose make sure the toggle switch is in the ON position, push the momentary push button switch until you have reeled in the amount of hose desire. Turn off the safety switch when not in use.

## FOAM MARKER

Located to the right of the control panel. Use lever on compressor to designate which boom is to be used to dispense foam. Use dial located on the foamer to adjust pressure for the amount of foam that will be dispensed. Switch on compressor also turns foamer on or off.

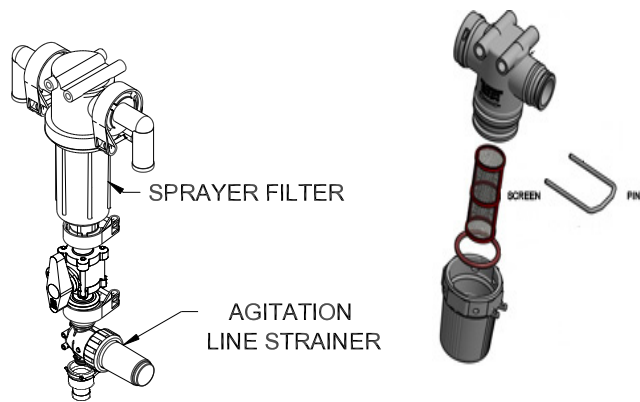



# WIRING DIAGRAM

## Color Code Chart

Bl	Blue
Br	Brown
Y	Yellow
G	Green
O	Orange

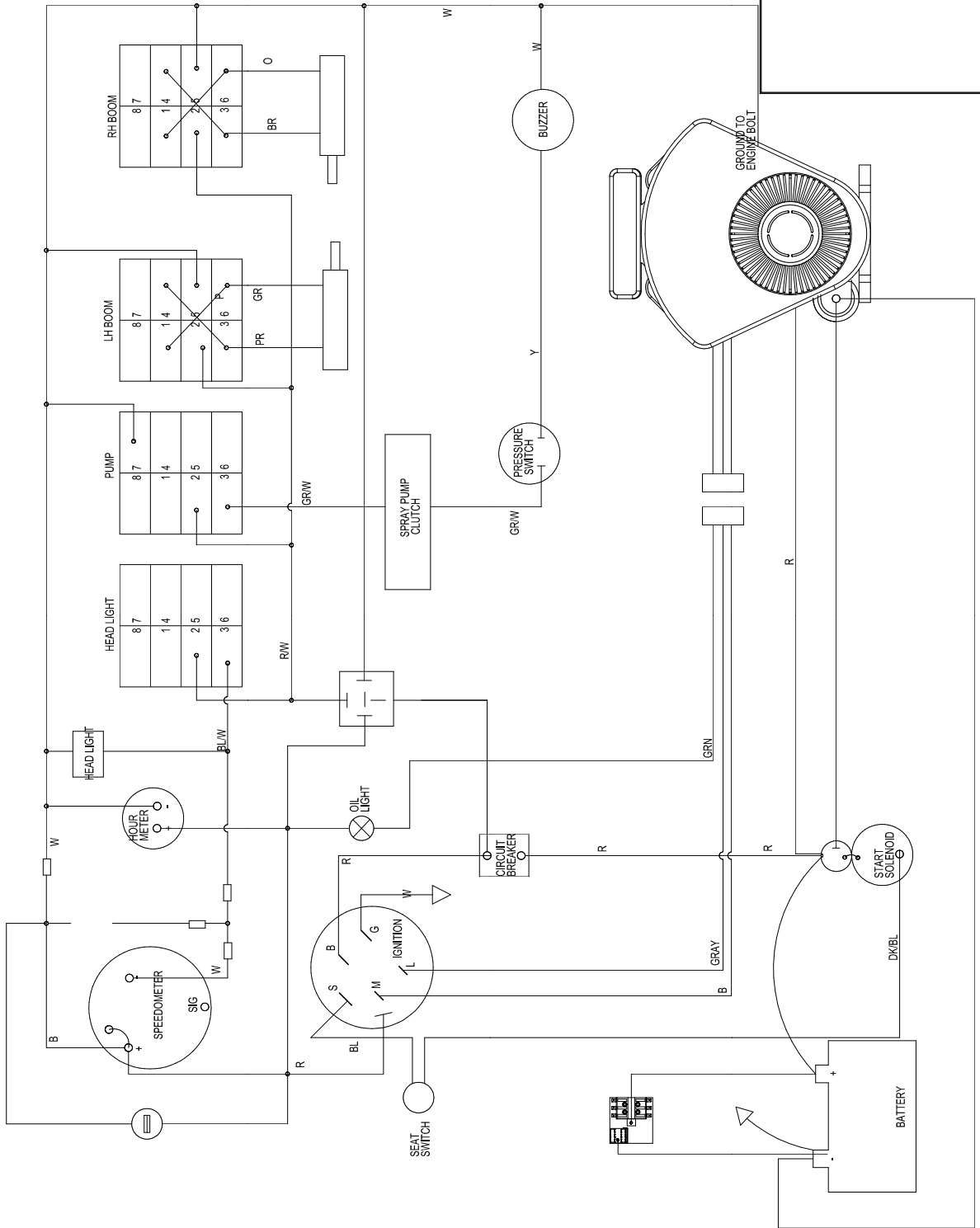

# HYDRAULIC DIAGRAM

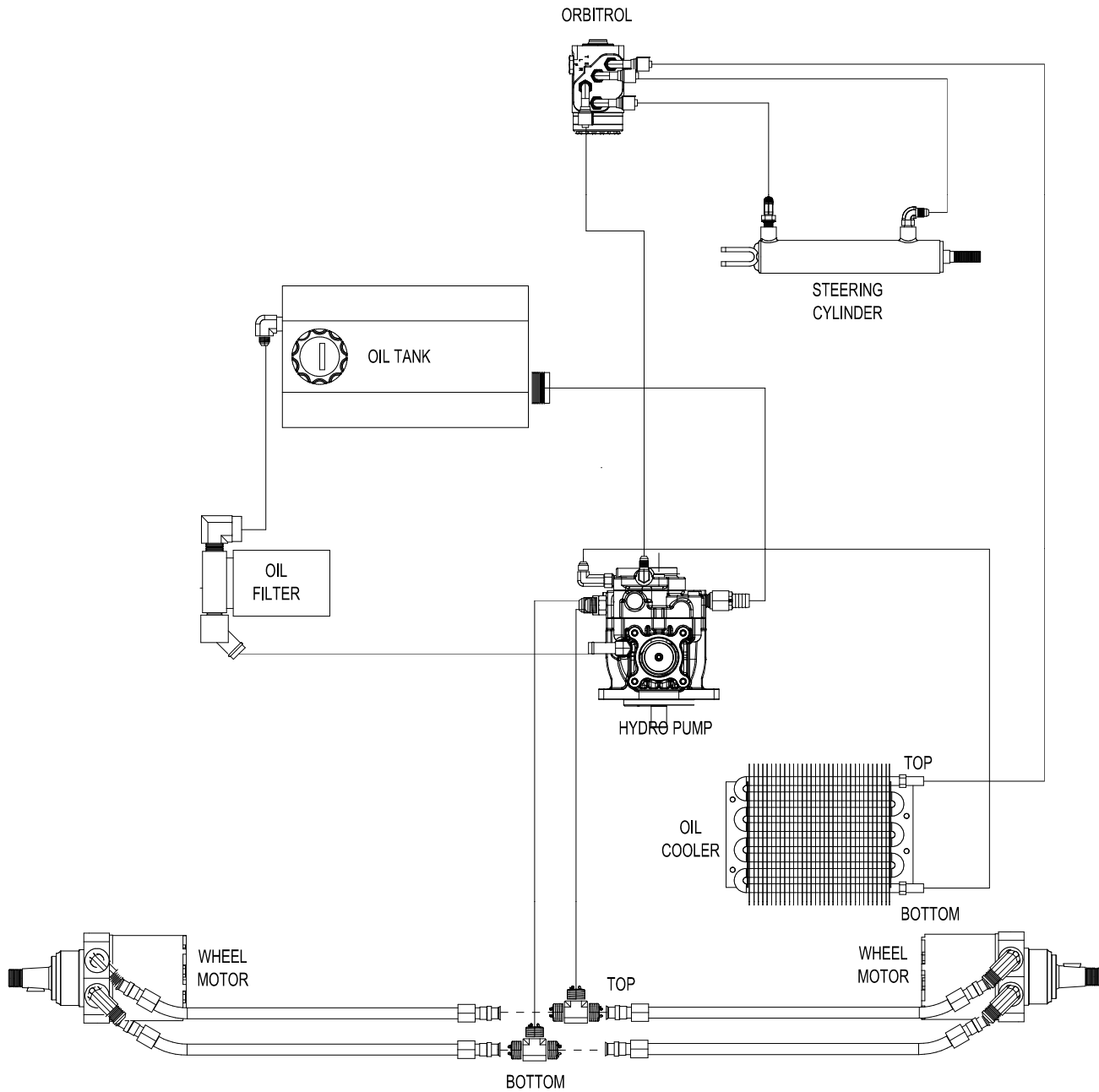

**DECLARATION OF CONFORMITY • ДЕКЛАРАЦИЯ ЗА СЪОТВЕТСТВИЕ • PROHLÁŠENÍ O SHODĚ • OVERENSSTEMMELSESERKLÆRING • CONFORMITEITSVERKLARING • VASTAVUSDEKLARATSIOON • VAATIMUSTENMUKAISUUSVAKUUTUS • DECLARATION DE CONFORMITE • KONFORMITÄTSEKTLÄRUNG • ΔΗΛΩΣΗ ΣΥΜΜΟΡΦΩΣΗΣ • MEGFELELŐSÉGI NYILATKOZAT • DICHIARAZIONE DI CONFORMITÀ • ATBILSTĪBAS DEKLARĀCIJA • ATITIKTIES DEKLARACIJA • DIKJARAZZJONI TAL-KONFORMITÀ • DEKLARACIA ZGODNOŚCI • DECLARAÇÃO DE CONFORMIDADE • DECLARAȚIE DE CONFORMITATE • VYHLÁSENIE O ZHODE • IZJAVA O SKLADNOSTI • DECLARACIÓN DE CONFORMIDAD • DEKLARATION OM ÖVERENSSTÄMMELSE**

Business name and full address of the manufacturer • Търговско име и пълен адрес на производителя • Obchodní jméno a plná adresa výrobce • Producentens firmanavn og fulde adresse • Bedrijfsnaam en volledig adres van de fabrikant • Tootja ärinimi ja täielik address • Valmistajan toiminimi ja täydellinen osoite • Nom commercial et adresse complète du fabricant • Firmenname und vollständige Adresse des Herstellers • Επισημια και ταχυδρομική διεύθυνση κατασκευαστή • A gyártó üzleti neve és teljes címe • Ragione sociale e indirizzo completo del fabbricante • Uzņēmuma nosaukums un pilna ražotāja adrese • Verslo pavadinimas ir pilnas gamintojo adresas • Isem kummerçjali u indirizz sñih tal-fabbrikant • Nazwa firmy i pełny adres producenta • Nome da empresa e endereço completo do fabricante • Denumirea comercială și adresa completă a producătorului • Obchodný názov a úplná adresa výrobcu • Naziv podjetja in polni naslov proizvajalca • Nombre de la empresa y dirección completa del fabricante • Tillverkarens företagsnamn och kompletta adress	<b>Smithco Inc. 34 West Avenue Wayne, PA USA 19087-3311</b>
Product Code • Код на продукта • Kód výrobku • Produktkode • Productcode • Toote kood • Tuotekoodi • Code produit • Produktcode • Кодовый продукт • Termékkód • Codice prodotto • Produkta kods • Produktu koda • Kodiçi tal-Prodott • Kod produktu • Código do Produto • Cod produs • Kód výrobku • Oznaka proizvoda • Código de producto • Produktkod	<b>10-100</b>
Machine Name • Наименование на машината • Název stroje • Maskinnavn • Machinenavn • Masina nimi • Laitteen nimi • Nom de la machine • Maschinenbezeichnung • Ονομασία μηχανήματος • Gépnév • Denominazione della macchina • Iekārtas nosaukums • Mašinos pavadinimas • Isem tal-Magna • Nazwa urzadzenia • Nome da Máquina • Numele echipamentului • Názov stroja • Naziv stroja • Nombre de la máquina • Maskinens namn	<b>Spray Star 1110</b>
Designation • Предназначение • Oznaceni • Betegnelse • Benaming • Nimetus • Tyypimerkintä • Pažymėjimas • Bezeichnung • Χαρακτηρισμός • Megnevezés • Funzione • Apzīmējums • Lithuanian • Denominazzjoni • Oznaczenie • Designação • Specificație • Oznaczenie • Nomen stroja • Descripción • Beteckning	<b>Turf Sprayer</b>
Serial Number • Серийн номер • Sériové číslo • Seriennummer • Seriennummer • Seriennummer • Valmistusnumero • Numéro de série • Seriennummer • Σειριακός αριθμός • Sorozatszám • Numero di serie • Sérijs numeris • Serijos numeris • Numru Serjali • Numer seryjny • Número de Série • Număr de serie • Sériové číslo • Serijska številka • Número de serie • Seriennummer	<b>100684-100999</b>
Engine • Двигател • Motor • Motor • Motor • Mootor • Mootori • Moteur • Motor • Μηχανή • Modulinėv • Motore • Dzinējs • Variklis • Sahha Netfa Installata • Silnik • Motor • Motor • Motor • Motor • Motor	<b>Briggs &amp; Stratton 23 HP 386447</b>
Net Installed Power • Нетна инсталирана мощност • Čistý instalovaný výkon • Installeret nettoeffekt • Netto geïnstalleerd vermogen • Installeeritud netovõimsus • Asennettu nettoteho • Puissance nominale nette • Installierte Nettoleistung • Καθαρή εγκατεστημένη ισχύς • Nettó beépített teljesítmény • Potenza netta installata • Paredzētā tīkla jauda • Grynoji galia • Wisa' tal-Qtugh • Moc zainstalowana netto • Potência instalada • Puterea instalată netă • Čistý inštalovaný výkon • Neto vgrajena moč • Potencia instalada neta • Nettoeffekt	<b>17 kW</b>
Conforms to Directives • В съответствие с директивите • Splňuje podmínky směrníc • Er i overensstemmelse med direktiver • Voldoet aan de richtlijnen • Vastab direktiividele • Direktivien mukainen • Conforme aux directives • Entspricht Richtlinien • Ακολουθήστε πιστά τις Οδηγίες • Megfelel az irányelveknek • Conforme alle Direttive • Atbilst direktīvām • Atitinka direktivų reikalavimus • Valutazzjoni tal-Konformità • Dyrektywy związane • Cumpre as Directivas • Respectă Directivele • Je v súlade so smernicami • Skladnost z direktivami • Cumple con las Directivas • Ilnfulir direktiv	<b>2006/42/EC; 2000/14/EC Annex VI . Part 1</b>
Conformity Assessment • Оценка за съответствие • Hodnocení plnění podmínek • Overensstemmelsesvurdering • Conformiteitsbeoordeling • Vastavushindamine • Vaatimustenmukaisuuden arviointi • Evaluation de conformité • Konformitätsbeurteilung • Διαπίστωση Συμμόρφωσης • Megfelelőség-értékelés • Valutazione della conformità • Atbilstības novērtējums • Atitikties įvertinimas • Livell tal-Qawwa tal-Hoss Imkejjel • Ocena zgodności • Avaliação de Conformidade • Evaluarea conformității • Vyhodnotenie zhodnosti • Ocena skladnosti • Evaluación de conformidad • Bedömning av överensstämmelse	<b>2006/42/EC Annex VIII</b>
Measured Sound Power Level • Измерено ниво на звукова мощност • Naměřený akustický výkon • Målte lydstyrkeniveau • Gemeten geluidsniveau • Mõõdetud helivõimsuse tase • Mittattu äänitehotaso • Niveau de puissance sonore mesuré • Gemessener Schalldruckpegel • Στοθμισμένο επίπεδο ηχητικής ισχύος • Mért hangteljesítményszint • Livello di potenza sonora misurato • Izmērtais skaņas jaudas līmenis • Išmatuotas garso stiprumo lygis • Livell tal-Qawwa tal-Hoss Iggarantit • Moc akustyczna mierzona • Nivel sonoro medido • Nivelul măsurat al puterii acustice • Nameranā hladina akustiského výkonu • Izmērjena raven zvočne moči • Nivel de potencia sonora medido • Uppmätt ljudeffektsnivå	<b>85dB(A)Lwa</b>
Guaranteed Sound Power Level • Гарантирано ниво на звукова мощност • Garantovaný akustický výkon • Garanteret lydstyrkeniveau • Gegarandeerd geluidsniveau • Garantēeritud helivõimsuse tase • Taattu äänitehotaso • Niveau de puissance sonore garanti • Garanterter Schalldruckpegel • Εγγυημένο επίπεδο ηχητικής ισχύος • Szavatolt hangteljesítményszint • Livello di potenza sonora garantito • Garantētais skaņas jaudas līmenis • Garantuotas garso stiprumo lygis • Livell tal-Qawwa tal-Hoss Iggarantit • Moc akustyczna gwarantowana • Nivel sonoro farantido • Nivelul garantat al puterii acustice • Garantovaná hladina akustického výkonu • Zajamčena raven zvočne moči • Nivel de potencia sonora garantizado • Garanterad ljudeffektsnivå	<b>88 dB(A)Lwa</b>
Conformity Assessment Procedure (Noise) • Оценка за съответствие на процедурата (Шум) • Postup hodnocení plnění podmínek (hluk) • Procedure for overensstemmelsesvurdering (Støj) • Procedure van de conformiteitsbeoordeling (geluid) • Vastavushindamismenetus (müra) • Vaatimustenmukaisuuden arviointimenetely (Melu) • Procédure d'évaluation de conformité (bruit) • Konformitätsbeurteilungsverfahren (Geräusch) • Διαδικασία Αξιολόγησης Συμμόρφωσης (Θόρυβος) • Megfelelőség-értékelési eljárás (Zaj) • Procedura de valutatezarea della conformității (rumore) • Atbilstības novērtējuma procedūra (troksnis) • Atitikties įvertinimo procedūra (garsas) • Procedura tal-Valutazzjoni tal-Konformità (Hoss) • Procedura oceny zgodności (poziom hałas) • Processo de avaliação de conformidade (nivel sonoro) • Procedura de evaluare a conformității (zgomot) • Postup vyhodnocovania zhodnosti (hluk) • Postopek za ugotavljanje skladnosti (hrup) • Procedimiento de evaluación de conformidad (ruido) • Procedur för bedömning av överensstämmelse (buller)	<b>2000/14/EC Annex VI Part 1</b>
UK Notified Body for 2000/14/EC • Нотифициран орган в Обединеното кралство за 2000/14/EO • Úřad certifikovaný podle směrnice č. 2000/14/EC • Det britiske bemyndigede organ for 2001/14/EF • Engels adviesorgaan voor 2000/14/EG • Ühendkuningriigi teavitatud asutus direktiivi 2000/14/EÜ mõistes • Direktiivin 2000/14/EY mukainen ilmoitettu tarkastuslaitos Isonsa-Britanniassa • Organisme notifié concernant la directive 2000/14/CE • Britische benannte Stelle für 2000/14/EG • Κοινοποιημένος Οργανισμός Ηνωμένου Βασιλείου για 2000/14/ΕΚ • 2000/14/ΕΚ – egyesült királyságbeli bejelentett szervezet • Organismo Notificato in GB per 2000/14/CE • 2000/14/ΕΚ AK regisztrētā organizācija • JK notifikuotais iestāgs 2000/14/EC • Korp Notifikat tar-Renju Unit ghal 2000/14/KE • Dopuszczona jednostka badawcza w Wielkiej Brytanii wg 2000/14/WE • Entidade notificada no Reino Unido para 2000/14/CE • Organism notificat în Marea Britanie pentru 2000/14/CE • Notifikovaný orgán Spojeného královstva pre smernicu 2000/14/ES • Britanski prijavljeni organ za 2000/14/ES • Cuerpo notificado en el Reino Unido para 2000/14/CE • Anúllt orgán na hEireann le haghaidh 2000/14/CE	<b>Smithco West Inc. 200 West Poplar Avenue Cameron, WI 54822 USA</b>
Operator Ear Noise Level • Оператор на нивото на доловим от ухото шум • Hladina hluku v oblasti uší operátora • Støjniveau i førers ørehøjde • Geluidsniveau oor bestuurder • Műratase operatortól körvas • Melutaso käyttäjän korvan kohdalla • Niveau de bruit à hauteur des oreilles de l'opérateur • Schallpegel am Bedienerohr • Επίπεδο θορύβου σε λειτουργία • A kezelő fülénél mért zajszint • Livello di potenza sonora all'orecchio dell'operatore • Trokšņa līmenis pie operatora auss • Dirbančiojo su mašina patiriamas triukšmo lygis • Livell tal-Hoss fil-Widna tal-Operatur • Dopuszczalny poziom hałasu dla operatora • Nivel sonoro nos ovidos do operador • Nivelul zgomotului la urechea operatorului • Hladina hluku pôsobiaci na sluch operátora • Raven hrupa pri užesu upravljavca • Nivel sonoro en el oído del operador • Ljudnivå vid förarens öra	<b>85 dB(A)Lwa (2006/42/EC)</b>

**Reference**



<p>Harmonised standards used • Използвани хармонизирани стандарти • Použité harmonizované normy • Brugte harmoniserede standarder • Gebuikte geharmoniseerde standaards • Kasutatud ühtlustatud standardid • Käytetyt yhdenmukaistetut standardit • Normes harmonisées utilisées • Angewandte harmonisierte Normen • Εναρμονισμένα πρότυπα που χρησιμοποιήθηκαν • Harmonizált szabványok • Standard armonizzati applicati • Izmantotie saskaņotie standarti • Panaudoti suderinti standartai • Standards armonizzati usati • Normy spójne powiązane • Normas harmonizadas usadas • Standardele armonizate utilizate • Použité harmonizované normy • Uporabljeni usklajeni standardi • Estándares armonizados utilizados • Harmoniserade standarder som används</p>	<p>ANSI/OPEI B71.4:2012 BS EN ISO 13857 BS EN 349:1993+A1:2008 BS 6356: P8 BS 6356:P5 BS EN 907</p>
<p>Technical standards and specifications used • Използвани технически стандарти и спецификации • Použité technické normy a specifikace • Brugte tekniske standarder og specifikationer • Gebuikte technische standaards en specificaties • Kasutatud tehnilised standardid ja spetsifikatsioonid • Käytetyt tekniset standardit ja eritelmät • Spécifications et normes techniques utilisées • Angewandte technische Normen und Spezifikationen • Τεχνικά πρότυπα και προδιαγραφές που χρησιμοποιήθηκαν • Műszaki szabványok és specifikációk • Standard tecnici e specifiche applicati • Izmantotie tehnikse standarti un specifikācijas • Panaudoti techniniai standartai ir techninė informacija • Standards u specifikkazzonijiet tehniki užati • Normy i specyfikacje techniczne powiązane • Normas técnicas e especificações usadas • Standardele tehnice și specificațiile utilizate • Použité technické normy a špecifikácie • Uporabljeni tehnični standardi in specifikacije • Estándares y especificaciones técnicas utilizadas • Tekniska standarder och specifikationer som används</p>	<p>SAE J1362</p>
<p>The place and date of the declaration • Място и дата на декларацията • Místo a datum prohlášení • Sted og dato for erklæringen • Plaats en datum van de verklaring • Deklaratsiooni väljastamise koht ja kuupäev • Vakuutuksen paikka ja päivämäärä • Lieu et date de la déclaration • Ort und Datum der Erklärung • Τόπος και ημερομηνία δήλωσης • A nyilatkozat kelte (hely és idő) • Luogo e data della dichiarazione • Deklarācijas vieta un datums • Deklaracijos vieta ir data • Il-post u d-data tad-dikjarazzjoni • Miejsce i data wystawienia deklaracji • Local e data da declaração • Local i data declarației • Miesto a dátum vyhlásenia • Kraj in datum izjave • Lugar y fecha de la declaración • Plats och datum för deklarationen</p>	<p>Smithco West Inc. 200 West Poplar Avenue Cameron, WI 54822 USA 15-Mar-18</p>
<p>Signature of the person empowered to draw up the declaration on behalf of the manufacturer, holds the technical documentation and is authorised to compile the technical file, and who is established in the Community. Подпис на човека, упълномощен да състави декларацията от името на производителя, който поддържа техническата документация и е оторизиран да изготви техническия файл и е регистриран в общността. Подпис osoby oprávněné sestavit prohlášení jménem výrobce, držet technickou dokumentaci a osoby oprávněné sestavit technické soubory a založené v rámci Evropského společenství. Underskrift af personen, der har fuldmagt til at udarbejde erklæringen på vegne af producenten, der er indehaver af dokumentationen og er bemyndiget til at udarbejde den tekniske journal, og som er baseret i nærområdet. Handtekening van de persoon die bevoegd is de verklaring namens de fabrikant te tekenen, de technische documentatie bewaart en bevoegd is om het technische bestand samen te stellen, en die is gevestigd in het Woongebied. Ühenduse registrisse kantud isiku allkiri, kes on volitatud toolja nimel deklaratsiooni koostama, kes omab tehnilisdokumentatsiooni ja kellel on õigus koostada tehniline toimik. Sen henkilö allekirjoitus, jolla on valmistajan valtuutus vakuutuksen laadintaan, jolla on hallussaan teknisetasiakirjat, joka on valtuutettu laatimaan tekniset asiakirjat ja joka on sijoittautunut yhteisöön. Signature de la personne habilitée à rédiger la déclaration au nom du fabricant, à détenir la documentation technique, à compiler les fichiers techniques et qui est implantée dans la Communauté. Unterschrift der Person, die berechtigt ist, die Erklärung im Namen des Herstellers abzugeben, die die technischen Unterlagen aufbewahrt und berechtigt ist, die technischen Unterlagen zusammenzustellen, und die in der Gemeinschaft niedergelassen ist. Υπογραφή στόμου εξουσιοδοτημένου για την σύνταξη της δήλωσης εκ μέρους του κατασκευαστή, ο οποίος κατέχει την τεχνική έκθεση και έχει την εξουσιοδότηση να ταξινομήσει τον τεχνικό φάκελο και ο οποίος είναι ιδιοκτήτης στην Κοινότητα. A gyártó nevében meghatalmazott személy, akinek jogában áll módosítania a nyilatkozatot, a műszaki dokumentációt őrizi, engedéllyel rendelkezik a műszaki fájl összeállításához, és aki a közösségben telepedett személy. Firma della persona autorizzata a redigere la dichiarazione a nome del fabbricante, in possesso della documentazione tecnica ed autorizzata a costituire il fascicolo tecnico, che deve essere stabilita nella Comunità. Tās personas paraksts, kura ir pilnvarota deklarācijas sastādīšanai ražotāja vārdā, kurai ir tehniskā dokumentācija, kura ir pilnvarota sagatavot tehnisko reģistru un kura ir apstiprināta Kopienā. Asmuo, kuris yra gana žinomas, kuriam gamintojas suteikė įgaliojimus sudaryti šią deklaraciją, ir kuris įspirašė, turi visą techninę informaciją ir yra įgaliotas sudaryti techninės informacijos dokumentą. Il-firma tal-persuna awtorizzata li tfassal id-dikjarazzjoni f'isem il-fabrikant, ghandha d-dokumentazzjoniteknika u hija awtorizzata li tikkompila l-fajl tekniku u li hija stabbilita fil-Komunità. Podpis osoby upoważnionej do sporządzenia deklaracji w imieniu producenta, przechowującej dokumentację techniczną, upoważnioną do stworzenia dokumentacji technicznej oraz wyznaczonej ds. wspólnolowych. Assinatura da pessoa com poderes para emitir a declaração em nome do fabricante, que possui a documentação técnica, que está autorizada a compilar o processo técnico e que está estabelecida na Comunidade. Semnătura persoanei împuternicite să elaboreze declarația în numele producătorului, care deține documentația tehnică, este autorizată să compileze dosarul tehnic și este stabilită în Comunitate. Podpis osoby poverenej vystavením vyhlásenia v mene výrobcu, ktorá má technickú dokumentáciu a je oprávnená spracovať technické podklady a ktorá je umiestnená v Spoločenstve. Podpis osebe, pooblašene za izdelavo izjave v imenu proizvajalca, ki ima tehnično dokumentacijo in lahko sestavlja spis tehnične dokumentacije, ter ima sedež v Skupnosti. Firma de la persona responsable de la declaración en nombre del fabricante, que posee la documentación técnica y que está autorizada para recopilar el archivo técnico y que está establecido en la Comunidad. Undertecknas av den som bemyndigad att upprätta deklarationen å tillverkarens vägnar, innehar den tekniskadokumentationen och är bemyndigad att sammanställa den tekniska informationen och som är etablerad i gemenskapen.</p>	<p>2006/42/EC Annex II 1A: 2 John Moore Sales, Director, Owner Moore Turf Care Thieplatz 4 49583 Liene Germany 23-Sep-19</p> <p>2006/42/EC Annex II 1A: 10 Dawn Bryngelson Technical Documentation Advisor Smithco Inc. 34 West Avenue Wayne, PA USA 19087-3311 10-Dec-09</p>
<p>Certificate Number • Номер на сертификат • Číslo osvědčení • Certifikatnummer • Certificaatnummer • Sertifikaadi number • Huväksyntänumero • Número de certificat • Bescheinigungsnummer • Αριθμός Πιστοποιητικού • Hitelesítési szám • Numero del certificato • Sertifikata numers • Sertifikato numeris • Numru tač-Certifikat • Numer certyfikatu • Número do Certificado • Număr certificat • Číslo osvedčenia • Številka certifikata • Número de certificado • Certifikatsnummer</p>	<p>10100-2021-1</p>



Reference



# QUICK REFERENCE REPLACEMENT PARTS

## REPLACEMENT FILTERS

23-031	Hydraulic Oil Filter Element 25 Micron	
13-531	Engine Oil Filter	Briggs# 842921
10-575-02	Air Filter	Briggs# 692519
10-575-03	Air Filter Pre-Cleaner	Briggs# 692520
50-403	In-Line Fuel Filter	

## REPLACEMENT BELTS

30-432	Belt (engine to Hypro® Pump)
--------	------------------------------

## SEAL KITS

15-301	Orbital
15-301-01	Repair Kit
77-263	Hydraulic Cylinder
14-530	Seal Kit
10-510	Wheel Motor
14-080	Seal Kit
45-373	DDC20 Piston Pump
45-373-01	Overhaul Kit
15-984	Hypro® Pump
16-967	Silicone - Carbon Seal Kit

## FLUIDS

Engine Oil	SAE 10W-40 API Service SJ or higher Motor Oil
Hydraulic Fluid	SAE 10W-40 API Service SJ or higher Motor Oil

## OTHER PARTS

13-488	Key Switch
8-709	Key Set
14-532	Hinged Cover On Tank with Gasket
16-953-01	Gasket For Cover
16-169	Strainer Basket
15-818	#75 Fitting O-ring
15-817	#50 Fitting O-ring
Spark Plugs	Champion type RC12YC (Gap 0.030 inch (.76 mm))

# The Smithco Commercial Products Two-Year Limited Warranty

Smithco, Inc. (Smithco) warrants your 2016 or newer Smithco Commercial Product (“Product”) purchased after October 1, 2016 to be free from defects in materials or workmanship for the period of time listed below. Where a warrantable condition exists, Smithco will repair the Product at no cost to you including diagnosis, labor (at the Smithco standard labor rate, subject to the Smithco flat rate schedule), and parts.

## Warranty Duration is:

- (1) Two years, 1500 operational hours\* from the date of delivery to the original purchaser or Five years from the date of original manufacturer of the product, whichever occurs first. (\*Products equipped with hour meter).
- (2) Products used in rental situations are covered for 90 days from date of delivery to original user/renter.

## Owner Responsibilities:

As the Product owner, you are responsible for required maintenance and adjustments stated in your Owner’s Manual. Failure to perform required maintenance and adjustments can be grounds for disallowing a warranty claim. **You are particularly responsible to train all present and future operators of this product on the safe operation of this product at your location.**

## Instructions for Obtaining Warranty Service:

You are responsible for notifying the Authorized Smithco Products Distributor from whom you purchased the Product as soon as you believe a warrantable condition exists and not later than 30 days from discovery of the condition.

If you need help locating an Authorized Smithco Distributor, or if you have questions regarding your warranty rights or responsibilities, you may contact us at:

Smithco Product Support Department  
200 West Poplar Ave.  
Cameron, Wisconsin 54822  
Telephone: 800-891-9435 E-Mail: [ProductSupport@Smithco.com](mailto:ProductSupport@Smithco.com)

## Maintenance Parts:

Parts scheduled for replacement as required maintenance (“Maintenance Parts”), are warranted for the period of time up to the scheduled replacement time for that part.

## Items/Conditions Not Covered:

Not all product failures or malfunctions that occur during the warranty period are defects in materials or workmanship. The items/conditions listed below are not covered by this warranty:



Product failures which result from the use of non-Smithco replacement parts, or from installation and use of add-on, modified, or unapproved accessories are not covered.



Product failures which result from failure to perform required maintenance and/or adjustments are not covered.



Product failures that result from operating the Product in an abusive, negligent or reckless manner are not covered.



This warranty does not apply to parts subject to consumption through use, unless found to be defective. Examples of parts which are consumed, or used up, during normal Product operation include, but are not limited to: blades, tines, teeth, scarifiers, rakes, plates, wear plates, castor wheels, tires, batteries, filters, belts, nozzles, etc.



This warranty does not apply to failures caused by outside influence. Items considered to be outside influence include, but are not limited to, weather, storage practices, contamination, use of unapproved coolants, lubricants, additives, or chemicals, etc.



This warranty does not apply to normal “wear and tear” items. Normal “Wear and Tear” includes, but is not limited to, damage to seats due to wear or abrasion, worn painted surfaces, scratched decals or windows, etc.



Smithco may require the return of failed parts or components in order to determine the validity of any warranty claim.



Smithco will not be obligated to replace components of other manufacturers if inspection by the original component manufacturer indicates that failure was due to normal wear and tear, expected consumption through use or improper care or service.

#### **Other Legal Disclaimers:**

The above remedy for product defects through repair or replacement by an authorized Smithco distributor or dealer is the purchaser’s sole remedy for any defect. This warranty gives you specific legal rights, and you may also have other rights which vary from state to state.

**THERE ARE NO OTHER EXPRESS WARRANTIES OTHER THAN THOSE SET FORTH ABOVE. ALL IMPLIED WARRANTIES OF MERCHANTABILITY AND FITNESS FOR USE ARE LIMITED TO THE DURATION OF THE LIMITED WARRANTIES CONTAINED HEREIN.**

Some states may not allow limitations on how long an implied warranty lasts, so the above limitation may not apply to you.

**THE SMITHCO COMPANY IS NOT LIABLE FOR INDIRECT, INCIDENTAL OR CONSEQUENTIAL DAMAGES IN CONNECTION WITH THE USE OF THE PRODUCT, INCLUDING ANY COST OR EXPENSE OF PROVIDING A SUBSTITUTE PRODUCT OR SERVICE DURING PERIODS OF MALFUNCTION OR NON-USE.**

Some states may not allow the exclusion of indirect, incidental or consequential damages, so the above exclusion may not apply to you.

**Smithco neither assumes, nor authorizes any person to assume for it, any other liability in connection with the sale or use of this product.**

